

The National Locksmith®

\$5.00

NEW!
G.M. Steering Column Course!
See Pages 48-49.

December 1995
Volume 66, No. 12

What's Happening Inside This Issue?

America's Locksmiths - - - - - p.120
How Do You Compare?
•Size
•Sales
•Service

The Painless Alarm Install p.136

Servicing The 1995 Celica p.132



Opening A Relocked Gary



p.144

1996 LOCKSMITH DIRECTORY

-  DISTRIBUTOR LISTINGS P. 11
-  MANUFACTURER LISTINGS P. 68
-  SCHOOL LISTINGS P. 111
-  ALARM MONITORING LISTINGS P. 111
-  ASSOCIATION LISTINGS P. 112
-  REPRESENTATIVE LISTINGS P. 114

PLUS ...
THE YEAR END ARTICLE INDEX
... AND MORE!

CONTENTS

December 1995 • The National Locksmith • Vol. 66, No. 12

FEATURES

- 11**
Distributor Listings
- 24**
Listings Of Distributors By State
- 33**
Listings Of Distributors By Product
- 68**
Manufacturer Listings
- 94**
Listings of Manufacturers By Product
- 111**
School Listings
- 111**
Alarm Listings
- 112**
Association Listings

- 114**
Representative Listings
- 118**
Year End Article Listing
- 120**
How Does Your Lock Shop Add Up
- 128**
Closing The Top Jamb Installation
- 132**
The 1995 Celica, Part 1
Servicing the new Celica.
- 136**
Installing A Wireless Security System
Wireless alarm installation made easy.
- 160**
Die-Diebold-Die!
Opening a Diebold TRTL30.

DEPARTMENTS

- 5** COMMENTARY
- 6** LETTERS
- 8** REED REPORT
- 99** LOCKSMITH CALENDAR
- 126** SECURITY CAFÉ
- 140** BEGINNER'S CORNER
- 142** BUSINESS BRIEFS
- 146** THE LIGHTER SIDE
- 165** TECHTIPS
- 184** THRU THE KEYHOLE
- 187** DISTRIBUTOR DIGEST
- 188** INDUSTRY MEETINGS
- 192** INDEX OF ADVERTISERS
- 194** TEST DRIVE

Editor/Publisher Marc Goldberg
Managing Editor Tom Serogy
Art Director Jim Darow
Production Director Edgar Shindelar
Production Assistant Jorge Carpio
Technical Editor Jake Jakubowski
Technical Writers Carl Cloud, Steve Gebbia, CML, Eugene Gentry, Bill Heine, Michael Hyde, Giles Kalvelage, Brian Kleiner, Ph.D., Dale Libby, Tom Mazzone, Dave McOmie, Don Probasco, Sara Probasco, Robert Sieveking
Director of Sales & Marketing Jeffrey Adair
Advertising Account Manager Debbie Wurtz
Circulation Manager Tom Dean
Accounting Manager Diane DeGrace
Administrative Assistant Michelle Buckley
Advisory Board Mike Elsberry, Steve Dyson, Buddy Logan, Sean DeForrest

National Publishing Co.
 The National Locksmith® ISSN #0364-3719 is published monthly by the National Publishing Co., 1533 Burgundy Parkway, Streamwood, Illinois 60107. Second class postage paid at Bartlett, Illinois 60107 and additional mailing offices USPS 040110. Subscriptions \$38.00 per year in the USA; \$50.00 per year in Canada; \$59.00 in all other countries. Single copies \$5.00 each. Postmaster, please send change of address to National Publishing Co., 1533 Burgundy Parkway, Streamwood, Illinois 60107. ©1995 by the National Publishing Company. All rights reserved. Printed in the U.S.A.



Questions or problems with you subscription?
 Call (312) 348-6358
 For all other inquiries, call
 (708) 837-2044, Fax: (708) 837-1210, or E-Mail: natllock@aol.com

On The Cover

Your direct line to the industry - The National Locksmith's 1996 Directory is faster and easier to use.



Commentary

Every year around this time it occurs to me that the past year has flown by with incredible speed. Perhaps the older you get, the quicker time goes. Am I the only one who has noticed that?

If you work on cars, you'll want to check out pages 48 and 49 of this month's issue. G.M. Technician Tom Mazzone has completed a true work of beauty. His G.M. Steering Column course will teach you all there is to know about working on virtually every domestic General Motors column you might possibly find on the road.

Tom is a factory trained General Motors mavin, and believe me you will be astounded by his course. The procedures are made simple, even the ones on very difficult columns. And the photography is nothing short of outstanding.

Along with the course, you receive a take-home test which examines your ability to locate critical information in your steering column course. When you are ready to do so, simply take the test and return it back to us here at the magazine. When you pass your test, we will certify you on G.M. Steering Column Service. So be sure to check out the ad.

Congratulations are in order for the former Debbie Schertzing and her new husband Tony Wurtz. Debbie is our Advertising Sales Associate and her co-workers cannot believe that she traded in the name Schertzing for Wurtz. Hey, at least it's shorter! (Personally I think she should have hyphenated...Wurtz-ing?)

As you know, we have been printing specialized test articles every month in *The National Locksmith*. Then, quarterly, we have included a test insert which you then returned to us in return for a certificate and seals.

We are changing that for 1996. We will still print the test articles. And quarterly, we will print the tests right in the magazine. Elsewhere in the issue will be an answer key. Thus you will be able to self-grade your tests immediately. The seals and certificates will be discontinued.

We here at the magazine want to wish you a happy and safe holiday season. Thank you for making 1995 a great year for us!



Marc Goldberg
Editor/Publisher

*Have a
happy and safe
holiday season!*

America Online: NATL LOCK
Use the above address if you are on AOL.
Internet: natllock@aol.com
Use the Internet address if you are not on AOL.

Marc Goldberg

DECEMBER 1995

Letters

The National Locksmith is interested in your view. We do reserve the right to edit for clarity and length.

SPC's Final Chapter

I am very disappointed to announce that this week the Security Professional Council agreed to disband as an organization.

The SPC spent more than three years experimenting with how to create a marketing strategy which would position locksmiths as the security experts for both residential and commercial customers. While we made some mistakes along the way it was the first time in the history of our industry that representatives from the manufacturer, wholesaler and locksmith levels worked together and we learned a great deal from the experience.

I believe now more than ever before that the locksmith industry, under ALOA's leadership, has a tremendous opportunity to position locksmiths as security experts in the minds of residential and commercial customers. Former members of SPC and others stand ready to help the locksmith industry should a long term plan be agreed upon by

locksmith industry leaders. The SPC showed they are capable of facilitating fund raising within the industry and act as a liaison with industry members. I hope former SPC members and other industry supporters have the opportunity to contribute in the future should a long term campaign be enacted.

In closing, I would like to thank all the people I have had the pleasure to work with these past few years. Marvin Cutson of Southern Lock and Don Bradford of Fairway Supply whose tenacity kept the SPC together; the manufacturers, Master, Medeco, and ASSA who provided invaluable insight on how we could pull together the whole channel; the trade publications for their unprecedented support of this program over the last several years; ALOA, for providing resources to help with many of our initial programs; NLSA, which provided the "seed" funding to get the program off the ground, and finally, individual locksmiths such as Randy Simpson, Jim Watt, Rick Ohmitt, Wayne Maris, Breck Camp, and Roy Renderer for their time and energy which helped develop many of the programs.

While I am saddened by the final chapter to the SPC story coming to an end, I look forward to a "golden time" for our industry for many years to come.

Sean DeForrest
SPC

Can You Help?

I recently purchased your book, *Antique Locks*, published by *The National Locksmith*. In this book you make reference to another title by Terry G. Roses. I'm unsure of the



exact title but I think it was "Story Lock: If locks could only Speak." I would greatly appreciate as much information about this as you can provide. Exact title, publisher availability etc. so that I can track it down.

I am a locksmith and a collector of old and antique locks and have a great interest in the "Story Locks". I've been in this business most of my life, over 60 years.

Thanks for your time and help. I really enjoyed your book. It was a great help in organizing my collection.

If there are titles, published by *The National Locksmith* or others that deal with the same subject, or antique locks in general, I'd appreciate any information you can give. Thank you for your interest.

Jay E. Nelson
Pennsylvania

Editor's Note: Jay, I'll give this one out to our readers. Anyone having information on where to locate this book, let us know here at *The National Locksmith*.

The National Locksmith
1533 Burgundy Parkway
Streamwood, IL 60107
Attn: Editor



Reed Report



Bill Reed

Scatter Shooting while wondering whatever happened to... Jim Miller

- Kwikset, Schlage, Master, Yale - top selling key blanks in America. Did you know that??
- I can't say enough good things about the people at the MINK Show in Omaha. I was the keynote speaker, and they presented me with a beautiful Cross pen and pencil set along with a BIG, beautiful birthday cake. What a group. Look forward to seeing them again next year.
- On March 9th & 10th the TRUST Seminar group will be in Eureka Springs, Arkansas for a two day show. You associations out there don't get any crazy ideas now. This two day show deal is a special one, and for the rest of the year I will book one day shows only. Your choice - Saturdays or Sundays.
- Congratulations go out to Illinois on their battle for legislation. They won! Provisions for the law will include insurance requirements, educational programs, fingerprint and background checks. I understand they have been allocated \$30,000 to write the testing programs, but they won't go into effect until January 1, 1997 and there WILL be a grandfather clause. I have spoken many times in the past that the Illinois program was the finest around, and I'm real happy for them. My hats off to Frank Schlessler, Kathy Zaniola, John Greenan, Bill Robertson, and Bill Pulley for their "stick-to-it" attitude. They did a swell job and one to be mighty proud of.
- We still need to adopt a definition for the word "locksmith." The dictionary prefers one or two sentence definitions and that's what most have now. Trouble is, they're the wrong words. Check me out in your dictionary if you don't believe me. The one we came up with is: "A Locksmith is an individual who has the ability to key a lock, install a lock, repair a lock, and bypass/neutralize a lock." I still say "key cutters" should be licensed. If we have to, Why not them?
- When doing my latest "millionaire locksmith" survey, I found that a large part (about 33%) of their income is from the banking industry. All pretty much agreed with me also that the real professional should become more involved with electronic safe locks, access control, auto specialization, and high security locks. I talked to several locksmiths, yes, "several" who did over \$45,000 monthly over the counter.
- What's the fastest growing segment of our industry? Institutional locksmithing! Lot of them out there, and getting bigger every day, tremendous market for you distributors.
- You'll be hearing more and more from me next year on "the locksmith and the home security systems." In the meantime,

Yours For Better Security,

Bill Reed

TNL

Welcome to *The National Locksmith 1996 Locksmith*

Directory. This year we bring you a new and improved Directory. The new design and sections of this Directory promise to be more advantageous to your business than ever before. Not only do you get the names, addresses and phone numbers of the hundreds of manufacturers and distributors serving our trade, this year you also have access to the cross references for those same manufacturers and distributors.

The cross references become a useful tool in your search for better product and services that your business needs to get ahead and grow.

The new cross reference sections include "Manufacturers By Product," "Distributors By State," and "Distributors By Product." Each section includes not only the name of the Manufacturer or Distributor, it also lists their location, phone number, fax number and E Mail number. With this directory there is no need to flip from one section to



the next looking for the information you need, it's all right there, where you need it!

The following sections appear in this year's Directory:

- Distributors - An alphabetical listing of all distributors that sell to locksmiths.
- Distributors By State - In this easy to use cross reference the distributors are listed by the state in which they are located. When looking for a distributor in your area, simply locate the state and distributors located there.
- Distributors By Product - In this easy to use cross reference the distributors are listed by the type of product

they stock and sell. Now you have quick easy access to a distributor when looking for specific types of products.

- Manufacturers - An alphabetical listing of all manufacturers that make product for the locksmith market.
- Manufacturers By Product - In this easy to use cross reference the manufacturers are listed by the type of product they make. It makes searching for a type of product fast and easy.
- Schools - An alphabetical listing of Locksmith correspondence and resident course schools.

• Alarms - An alphabetical listing of alarm and alarm product manufacturers.

• Associations - International, national and state Locksmith Associations listed by State.

• Representatives - A listing of manufacturer representatives listed by state.

As always, we've tried to make this Locksmith Directory complete with all the information you might need throughout the year. However, it is possible that some information might have inadvertently been omitted. We apologize, and ask that you send the missing or changed information to us in writing so that it may be included in our next upcoming directory. Send additions and/or changes to *The National Locksmith*, 1533 Burgundy Pkwy, Streamwood, IL 60107, Attn: Directory Changes.

As a closing note, the few manufacturers/distributors that do not include information following the product categories, carry a range of products for the locksmith.



SCHWAB CORP.

Fire protection for your vital records.

**It's not safe unless
it's Schwab Safe.**

[Click here for more information](#)

DISTRIBUTORS

A.T. Jones & Son
1456 Broadway
Detroit, MI 48226
800-735-4570
313-965-1455
Fax: 313-965-1093
Key Personnel: John Dunn, Sales, Matt Trupiono, Barb Haskell
Product Categories: B D E F G
Branches:
Warren, MI
810-756-8400, Fax 810-756-8401

Access Safe & Supply Ltd.
5035 N. Service Rd. D15
Burlington, Ont., Canada L7L 5V2
800-268-9033
905-319-0355
Fax: 905-319-0366
Key Personnel: Peter K. Gauthier, Pres., Glenn Davey, Sales & Mktg.
Product Categories: C D E F G H

Accredited Lock Supply Co.
P.O. Box 1442
Secaucus, NJ 07096-1442
800-652-2835
201-865-5015
Fax: 201-865-5031
Key Personnel: Ron Weaver, Pres., Rich Chakov, GM
Product Categories: A B C D E F G H

Ace Lock & Security Supply
565 Rahway Ave.
Union, NJ 07083
800-223-5625
908-688-7666
Fax: 908-688-2442
Key Personnel: Daniel Goldstein, Pres., Robin Cherkes, VP, Robert Bernstein, Dir. Sales & Mktg.
Product Categories: A B C D E F G H
See ads on pages 15, 36, 115 & 140

Ace Lock, The Security People
5964 Baum Square
Pittsburgh, PA 15206
412-363-3328
Key Personnel: Sandra Hunter, Pres.
Product Categories:

Acme Security Systems
1922 Republic Ave.
San Leandro, CA 94577
800-348-2263
510-483-5000
Fax: 800-435-8233
E Mail: john@locks.com
Key Personnel: Rich Harsha, Wholesales & Sales Coord., Scott Rogers, John Ream, VP
Product Categories: A B E F

Acme Wholesale Distributors
See IDN - Acme

Action Hardware, Inc.
3428-C Vane Ct.
Charlotte, NC 28206
704-334-1577
Key Personnel: Brady Woody, GM
Product Categories:

Adams Lock & Safe Co., Inc.
130 Hall St.
Concord, NH 03301
800-635-2228
603-224-1652
Fax: 603-226-4983
Key Personnel: David C. Holt
Product Categories: B F H

Advaco Security Products
3340 Tweedy Blvd.
Southgate, CA 90280
213-564-1662
Fax: 213-564-9622
Key Personnel: Ralph Davidson
Product Categories:

ADI
165 Eileen Way
Syosset, NY 11791
516-921-6704
Fax: 516-921-8118
Key Personnel: Leo A. Guthart, Chair.
Product Categories:

Aetna Hardware Corp.
5909 W. Lisbon Ave.
Milwaukee, WI 53210
414-445-1800
Key Personnel: Sharon Braden
Product Categories:

Agences W. Pelletier (1980) Inc.
440 Beaumont
Montreal, Quebec, Canada H3N 1T7
800-363-6700
514-276-6700
Fax: 514-276-9413
Key Personnel: A. Cheply, GM, B. Sanssovci, Sales & Mktg. Mgr.
Product Categories: A B C D E F G H
Buying Group Affiliations: Agences R. Cantin, Inc. Quebec, Canada 418-681-7522, 418-681-1075

Akron Hdw. Consultants
2579 S. Arlington Rd.
Akron, OH 44319
800-321-9602
216-644-1167
Fax: 800-328-6070
Key Personnel: Kenneth E. Orihel
Product Categories: B F
Branches:
Chandler, AZ
800-457-9378, 800-457-8773

Alarm Suppliers
780 Dubuque Ave.
S. San Francisco, CA 94080
415-871-7378
Fax: 415-871-7497
Key Personnel: Patrick Oehlsen
Product Categories:

Alertco, Inc.
2411 Crawford Avenue
Evanston, IL 60201
708-869-1524
Key Personnel: Jim Higginbotham, Pres.
Product Categories:

Allegheny Lock Co., Inc.
1006-08 Collman Ave.
Philadelphia, PA 19111
215-745-1217
Key Personnel: Bob Mastrangelo
Product Categories:

Allied Locksmith Supply
P.O. Box 3137
Youngstown, OH 44513
800-544-2102
216-726-0866
Fax: 216-726-0865
Key Personnel: Rudy R. Wiesner, Pres., Jim Dravec, Oper. Mgr., Bill Stark, Cust. Svc./Sales
Product Categories: C D F G

Alno, Inc.
9725 Owensmouth Ave.
Chatsworth, CA 91311
Key Personnel: Jack Fase, Pres.
Product Categories:

Ambassador Wholesale Safe Distributors
21 North Beverwyck Rd.
Lake Hiawatha, NJ 07034
800-999-5510
201-263-3768
Fax: 201-402-1447
Key Personnel: Jeff Hale, Pres., Larry Hale, Scty., Karen A. Hale, GM
Product Categories: H
See ad on page 10

American Access Supply
4304 S. 131st Pl
Seattle, WA 98168
800-559-9634
206-244-7269
Fax: 800-243-3049
E Mail: 171
Key Personnel: Steven Linhart, Gene Bergmann, Tech. Assoc., Brian Gordon, IA Sales Mgr.
Product Categories: E F G

Branches:
Los Angeles, CA
800-858-1726
310-568-9885
Fax: 310-568-1507

American Lock & Key Co.
2110 Spencer Rd.
Richmond, VA 23230
800-995-6247
804-282-6060
Fax: 804-282-1007
Key Personnel: Barry Wilson, Harry Wilson, Treas.
Product Categories: B E F H

American Lock & Supply, Inc.
4411 E. LaPalma Avenue
Anaheim, CA 92807
800-854-8775
714-996-8882
Fax: 714-579-7554
Key Personnel: Sean DeForrest - President/CEO, Bill Power - Vice President Sales, Rick Myers - Vice President Marketing
Product Guide: B E F G H

Branches:
Atlanta, GA
800-952-4452
404-458-1899
Fax: 404-458-0899, 800-358-4561

Elkridge, MD
800-358-6398
410-379-5300
Fax: 410-379-5990, 800-358-6399

Boston, MA
800-291-2797
Fax: 800-291-2798

Elmhurst, IL
800-621-0177
708-832-8999
Fax: 708-832-9084, 800-238-5397

Dallas, TX
800-292-0115
214-358-0471
Fax: 214-358-6037, 800-527-3028

Denver, CO
800-346-5549
303-733-1423
Fax: 303-733-0202, 800-241-0202

Houston, TX
800-435-8105
713-681-2790
Fax: 713-681-0850, 800-435-8232

Kansas City, KS
800-888-5625
913-432-2739
Fax: 913-432-1342, 800-395-7945

Hauppauge, NY
800-628-5625
516-231-0516
Fax: 516-231-2019, 800-424-7185

Fremont, CA
800-227-1142
510-651-1400
Fax: 510-651-2350, 800-662-4399

Phoenix, AZ
800-826-6968
602-256-7983
Fax: 602-254-0272, 800-325-3728

San Diego, CA
800-231-8435
Fax: 800-788-0916

Seattle, WA
800-356-5661
206-244-7269
Fax: 206-431-8527, 800-392-1132

Anaheim, CA
800-854-8775
714-996-8882, 213-585-0224
Fax: 714-579-7554, 714-528-4201

Los Angeles, CA
800-858-1726
310-568-9885
Fax: 310-568-1507

Seattle, WA
800-559-9634
Fax: 800-243-3049

AmoraTech, Inc.
355 Old State Rd.
P.O. Box 100
Shermans Dale, PA 17090-0100
717-582-8114
Fax: 717-582-7549
E Mail: Internet
74617.1477@compuserve.com
Product Categories: G

Amos Lock & Key Supply Co.
2711 Cullen St.
Fort Worth, TX 76107
800-772-7432
317-335-5397
Fax: 317-335-5399
Key Personnel: Amos Strange, Pres.
Product Categories: B F G

Anchor Safe Co.
2627 E. 8 Mile Rd.
Warren, MI 48091
800-541-8050
810-755-3570
Fax: 810-755-1760
Key Personnel: John Szechowycz, VP, Orest Kalba, Pres.
Product Categories: H

Anderson Lock Co.
1801 Oakton St.
Des Plaines, IL 60018
708-296-1157
Fax: 708-296-9259
Key Personnel: Eugene R. Anderson, Pres., Norm Anderson, VP
Product Categories: B C E F G

Andrew's Wholesale Lock Supply
544 South 9th St.
Lebanon, PA 17042
800-544-0519
717-274-8733
Fax: 717-274-8659
Key Personnel: Richard A. Rudy, Owner, Pat Kreison
Product Categories: F

Anytime Security Products
646 Longfellow Ave.
Hermosa Beach, CA 90254
800-539-2427
310-798-5397
Fax: 310-798-4604
Key Personnel: Robin Varian
Product Categories: F

Product Category Key

A — Alarms
B — Architectural Hardware
C — Training Manuals & Materials
D — Locksmith Software
E — Electronic Security Products
F — Locking Products
G — Locksmith Tools & Equipment
H — Safes & Safe Products

Apex Security Hardware Corp.
1201 36th St.
Brooklyn, NY 11218
800-232-1117
718-438-2115
Fax: 718-438-3327, 800-951-7000
Key Personnel: Eli Guth, Pres.
Product Categories: B E F G

Architectural Products By Outwater,
L.L.C.
52 Passaic Street
Woodridge, NJ 07075
800-835-4400
201-365-2002
Fax: 800-835-4403
E Mail: gottlieb@ios.com
Key Personnel: Carolyn McCrystall,
GM
Product Categories: B F
Branches:
Outwater Design Center, New York,
NY
212-966-6366, 212-925-3465

Aristo Sales Co., Inc.
27-24 Jackson Ave.
Long Island City, NY 11101
800-221-1322
718-361-1040
Fax: 718-937-5794
Key Personnel: Jules Rosenblatt, V.P.
Sales, Leonard Rosenblatt, V.P.
Operations, Joe Lewanduski, Manager
Product Categories: C F G

Armstrong's Lock & Supply Inc.
See IDN - Armstrong's

ASLA Distributing
P.O. Box 54
East Rockaway, NJ 11518
516-766-2863
Fax: 516-766-2863
Key Personnel: Arnold Dean, Lee List
Product Categories: B F

Associated Lock & Supply
2526 Davies Ave.
Port Coquitlam, BC, Canada V3C
4T7
800-373-5754
604-942-5625
Fax: 604-942-3761
Key Personnel: Greg Smith, Sr. Pres.
Product Categories: A C D E F G H

Atlantic Lock & Key
4064 N. 30th Ave.
Hollywood, FL 33020
305-966-9862
Fax: 305-962-1202
Key Personnel: Steve Blaustein
Product Categories:

Automatic Gate Wholesalers
3900 Pelandale #420, Ste. 350
Modesto, CA 95356
800-238-2301
Fax: 800-438-2301
Key Personnel: Steve SanFilippo, VP,
Tony Hird, Office Mgr./Sales, Lynda
Mull, Mktg./Sales
Product Categories: E F

Autotech Accessories, Inc.
150 - 77th St.
Brooklyn, NY 11209
718-680-8901
Fax: Automatic
Key Personnel: Jerry Petrino, Pres.
Product Categories: A E F

Avco Key Supply
220 Church St.
Northport, NY 11768
800-332-5397
516-261-6453
Fax: 800-329-5397
E Mail: Internet avcokey@aol.com
Key Personnel: Michael Avena, Pres.,
Matt Sultherland, Sls Mgr.
Product Categories: F G

Barry Supply Co., Div. of Barry Ind.
Inc.
36 West 17th St.
New York, NY 10011
212-242-5200
Fax: 212-675-7094
Key Personnel: B. Wein, Sales, Andy
Seller, Prod. Mgr., William Wein,
Sales Mgr. US
Product Categories: B

Bell's Security Sales
411 Bloomfield Ave.
Bloomfield, NJ 07003
800-772-2266
201-743-3709
Fax: 201-743-6357
Key Personnel: Dale Middleton, Pres.,
Rick Middleton, Exec. VP, Dennis
Jarvis, Purch. Agent
Product Categories: A B E F G

Berg Wholesale Inc.
P.O. Box 29169
Portland, OR 97229
503-220-0000
Fax: 503-228-9410
Key Personnel: Rick Stewart
Product Categories:

Blaydes Lock Co., Inc.
2335 18th St. NE
Washington, DC 20018
800-424-2650
202-832-7100
Fax: 202-832-1359
Key Personnel: Jack Hildebrand, Pres.,
Tom Rakes, VP, Andy Hildebrand,
Sec. Tres.
Product Categories: A B C E F G
See ad on page 169

Blue Dog
P.O. Box 160006
Altamonte Springs, FL 32716
800-248-2887
407-774-0100
Fax: 407-774-6054
E Mail: bluedogkeys@aol.com
Key Personnel: Liam Gribben, Owner,
Sharon Beecher, Office Mgr.
Product Categories: G

Boston Lock & Safe Co., Inc.
30 Lincoln St.
Brighton, MA 02135
800-252-5757
617-787-3400
Fax: 617-787-3425
Key Personnel: David J. Stoia, Pres.,
Theodore E. Stoia, VP, James C.
Comdil, VP
Product Categories: B E F G H

Boyle & Chase, Inc.
P.O. Box 72
Accord, MA 02043
800-325-2530
800-462-6240
Fax: 617-335-5342
Key Personnel: Michael Rotondi, Pres.,
Robert Kent, Mgr.
Product Categories: B D E F
See ad on page 41

Brady Office Machine Security
11056 S. Bell Ave.
Chicago, IL 60643
800-326-8349
312-779-8349
Fax: 312-779-9712
Key Personnel: Bernadette Brady,
Pres., Edward Brady, VP
Product Categories: F

Brondco Distributing
2001 Camelot
Cleveland, OH 44116
216-331-1556
Key Personnel: Dean Brondos
Product Categories:

Brook's Lock & Key, Inc.
411 6th Street SE
Decatur, AL 35601
800-292-5008
205-353-2596
Fax: 205-353-8260

Key Personnel: Larry A. Warnick, CML
Pres., Carole S. Warnick, VP, Bobby
Hill, GM
Product Categories: A B E F G H
Branches:
Huntsville, AL
Huntsville, AL

Brooks Supply, Inc.
321 Scott St.
Oklahoma City, OK 73115-1095
800-347-4477
405-677-0504
Fax: 405-672-7575
Key Personnel: Gene Brooks, Pres.
Product Categories: B C D E F G H
Branches:
Colorado Springs, CO
800-748-3772, 719-591-7272,
719-591-7275

Buffalo Safe & Lock
4063 Seneca St.
W. Seneca, NY 14224
800-255-6257
716-674-1127
Fax: 716-674-4645
E Mail: safecracker@aol.com
Key Personnel: John S. Blando,
Owner, Dixie Lea Blando, Mgr.,
Karen Weigand, Ship. Dept. Mgr.
Product Categories: F G H

C&H Lock & Saw Co.
4112 Summer Ave.
Memphis, TN 38122
901-682-5691
Key Personnel: Clyde Casey

C.E. Sanders
18608 Walker Rd.
Lutz, FL 33549
813-948-3162
Fax: 813-949-1874
Key Personnel: Calvin Sanders,
Owner, Carol E. Sanders
Product Categories: F

C.H. Edwards, Inc.
P.O. Box 775, Hwy. 11 South
Greenville, NC 27835
919-756-8500
Fax: 919-756-3884
Key Personnel: Bill Branch, Buddy
Breacham, Jim Umphelt
Product Categories: B

Canaan Distributors
61 Crescent St.
Stamford, CT 06906
203-356-1000
Key Personnel: Mr. Reynoso
Product Categories:

Canada Lock Products
See IDN - Canada

Capitol Lock Co. Inc.
9815 Rhode Island Ave
College Park, MD 20740
301-513-9500
301-513-9505
Key Personnel: Walt Schlegal V.P.
Product Categories: B F G

Citizens Defensive Products
2206 Monterey Dr.
St. Joseph, MO 64507
816-233-1512
Fax: 816-233-3092
Key Personnel: Mel Wigersma
Product Categories: A E

City Intercoms, Inc.
15 Eldridge St.
New York, NY 10002-0565
800-248-9468
Fax: 800-598-2865
Key Personnel:
Product Categories: E

City Lock Supply
2900-C Valmont Rd.
Boulder, CO 80301
303-444-4407
Fax: 303-442-8380
E Mail: dougsdigs@aol.com

Key Personnel: Jeffrey Rosen, Pres.
Product Categories: F G

Clark Security Products
7140 Engineer Road
San Diego, CA 92111-1491
800-854-2088
619-565-7140
Fax: 619-565-4605
Key Personnel: Marshall Merrifield -
President, Virginia Merrifield - Vice
President, Anne Riley - Marketing
Director
Product Guide: B C D E F G H
Branches:

Denver, CO
800-282-5625
303-288-9200
Fax: 800-699-3329

Phoenix, AZ
800-775-5625
602-275-4431
Fax: 602-275-9235

W. Sacramento, CA
800-245-3003
916-372-6630
Fax: 916-372-7221

Seattle, WA
800-942-5275
206-467-3000
Fax: 800-546-5625

Lanham, MD
800-58-5625
301-731-4100
Fax: 800-378-5625

Bell, CA
800-889-5625
213-262-2666
Fax: 213-262-0741

Auburn, MA
800-746-2562
508-832-5370
Fax: 800-596-5625

Salt Lake City, UT
800-453-6430
801-487-3227
Fax: 801-487-3254

Wood Dale, IL
800-755-5625
708-350-8500
Fax: 708-350-8535

Closed Circuit Designs
20316 NE 16 Pl.
N. Miami Beach, FL 33179
800-228-8321
305-652-8567
Fax: 305-652-3471
Key Personnel:
Product Categories: A E

Colombus Door Company
1884 Elmwood Ave.
Warwick, RI 02888
401-781-7792
Fax: 401-467-3620
Key Personnel: David Constantino
Product Categories:

Colonial Lock Supply Co., Inc.
7000-G Newington Rd., P.O. Box
1417
Newington, VA 22122
800-732-9117
703-550-8558
Fax: 703-550-8857
Key Personnel: Gary Baldino, GM,
Don Dassing, Sales
Product Categories: B E F G H

Product Category Key

- A — Alarms
- B — Architectural Hardware
- C — Training Manuals & Materials
- D — Locksmith Software
- E — Electronic Security Products
- F — Locking Products
- G — Locksmith Tools & Equipment
- H — Safes & Safe Products

Continued on page 14

Continued from page 12

Commonwealth Lock Co.
1853 Mass Ave.
Cambridge, MA 02140
800-442-7009
617-876-3301
Fax: 617-661-3168
Key Personnel: Edward A. Mayer,
Pres., Cathy-Amm Accomando, Mgr.
Product Categories: A B D E F G H

Cook's Building Specialties, Inc.
2441 Menaul Blvd, NE
Albuquerque, NM 87107
505-883-5701
Fax: 505-883-5704
Key Personnel: Pat Mares, Purch. Agt.,
Max Mallory, Salesman, Todd
Beeman, Salesman
Product Categories: F G

Cook's Supply Inc.
See IDN - Acme

Craftmaster Hardware Co., Inc.
134 Liberty St.
Hackensack, NJ 07601
800-221-3212
201-646-9355
Fax: 201-646-0181
Key Personnel: Michael Springeld,
Pres., Anthony Cani, VP Sales & Mktg.
Product Categories: B C D E F G

Curtis Industries Inc.
34999 Curtis Blvd.
Eastlake, OH 44094
800-555-5397
Key Personnel: Ken Pross
Product Categories: G
See ad on page 99

Cypress Security Products Ltd.
5A, 4101 19 Street NE
Calgary, AB, Canada T2E 6X8
800-561-1967
403-250-1967
Fax: 403-250-1969
Key Personnel: Bruce Bohnet, Pres.
Product Categories: B E F

Dave Sanders & Co. Inc.
107 Bowery
New York, NY 10002
212-334-9898
Fax: 212-966-4185
Key Personnel: Paul Sheopaul, Sales
Manager, Moe De Jesus, Customer
Service Rep., Steven Lee, Customer
Service Rep.
Product Categories: B

Dealer Connection, Inc.
512 W. 5th St.
Naperville, IL 60563
800-500-4500
708-717-2800
Fax: 708-717-2805
Key Personnel: Thomas McHugh, VP
Sales, Thomas A. Brown, VP
Operations
Product Categories: E

Defiant Safe Co.
3130 Towerwood
Dallas, TX 75234
800-225-2984
214-243-3711
Fax: 214-241-7669
Key Personnel: David Randall, Nat'l
Sales Mgr., Richard Rolland, Pres.
Product Categories: H

DiMark International
3117 Liberator - Unit A
Santa Maria, CA 93455
800-235-2435
805-922-1182
Fax: 805-928-8034
Key Personnel: Mark Pirman, Diane
Pirman, CFO, Mgr.
Product Categories: C D F G
See ad on page 63

Door Closer Service Co., Inc.
3730 10th St. NE
Washington, DC 20017
800-566-0606
202-526-0505
Fax: 800-908-3667, 202-529-7826

Key Personnel: Angela & Larry
Sanders, Pres & VP, John Edward,
Sales Mgr., Kevin Guerra, Controller
Product Categories: B
See ad on page 32

**Door Hardware
Distributors, Inc.**
318 North Milwaukee St.
Milwaukee, WI 53202
800-829-8905
414-291-5687
Fax: 414-291-5685
Key Personnel: Deborah J. Pokrass,
Pres., Andrew S. Pokrass, VP Sales
Product Categories: B
See ad on page 132

Doyle Lock Supply, Inc.
2211 West River Road North
Minneapolis, MN 55411
800-333-6953
612-521-6226
Fax: 612-521-0166
Key Personnel: Robert Hromadko,
Pres., Paul M. Justen, GM
Product Categories: B C D E F G H
Buying Group Affiliations: USCAN

DRK Specialties, Keyrings & Things
5671 Sonoma Dr., Suite #B
Fremont, CA 94566
800-654-1850
510-417-8880
Fax: 510-471-8885
Key Personnel: Don R. Kuhn, Pres.,
Gloria Kuhn, Treas., Kelly Kuhn, Office
Mgr.
Product Categories:

Dugmore & Duncan Inc.
30 Pond Park Road
Hingham, MA 02043
800-225-1595
617-740-1101
Fax: 617-740-4043

Key Personnel Tom Fuery - Branch
Manager
Product Guide: B E F G

Branches:
Lakeland, FL
800-232-1595
813-667-0866
Fax: 813-666-5226
See ad on page 73

Riverside, CA
800-325-1595
909-360-0222
Fax: 909-360-0572

E.L. Reinhardt
3250 Fanum Rd.
Vadnais Heights, MN 55110-5219
800-328-1311
612-481-0566
Fax: 612-481-0166
Key Personnel: Kenneth J. Stemig,
Pres., Kenneth Paul Stemig, VP, John
Eldred Stemig, VP
Product Categories: A B C D E F G H
Buying Group Affiliations: Professional
Lock Suppliers (PLS)

Edw. Saucedo & Son Co., Inc.
709-711 N. Copia St.
El Paso, TX 79903
800-248-3726
915-566-7101
Fax: 915-566-8608
Key Personnel: D.E. Saucedo, GM
Product Categories: B E F G H

Ellay Express
P.O. Box 1388
Hingham, MA 02043
800-432-1311
708-480-1311
Fax: 708-480-1383

**Lockmasters has a
44 year history of
training security
professionals.**

[Click here for more information](#)

Key Personnel: Mark Vaughn, Sales Mgr., Jackie Ripes, Salesperson
Product Categories: B E F

EMG Associates

645 N. Michigan Ave.
Chicago, IL 60611
800-468-3558
312-649-0662
Fax: 312-649-0787
Key Personnel: Joshua B. Alper, Pres.,
Maureen Halloron, Credit, Ron Nigro,
Tech. Support
Product Categories: E F
See ad on page 34

Empire Security Supplies
4600 B Neconset Hwy.
Pt. Jefferson Station, NY 11776
516-928-1919
Fax: 516-928-4745
Key Personnel: Ira Levine, Pres.
Product Categories: A B E F H

Enixus Trade, Ltd.
34 Dunkirk Rd.
St. Catharines, Ont., Canada L2R
1A1
905-682-3086
Fax: 905-682-3086
Key Personnel: George Papaiz, Bruno
Papaiz, Director
Product Categories: B F G

Ewert Wholesale Hardware Inc.
4709 W. 120th St.
Alsip, IL 60658
800-451-0200
708-597-0059
Fax: 708-597-0881
Key Personnel: Brian King, Sales, A.
Wesley McKenney, Marc Luber
Product Categories: B C D E F G H

Express Hardware
1203 S. Northwest Hwy.
Barrington, IL 60010
800-323-7447
708-381-9430
Fax: 708-381-7199
Key Personnel: Steve Yellin, Pres.
Product Categories: B E F

Fairway Supply, Inc.
4303 Dacoma
Houston, TX 77092
800-767-3247
713-957-2160
Fax: 713-957-2122
Key Personnel: Don Bradford, Pres.,
Rick Gummelt, VP, Bob Conley, VP
Product Categories: A B C D E F G H

Fastrack Hardware, Inc.
3655 North 126th St.
Brookfield, WI 53005
800-458-8707
Fax: 800-667-8701
Key Personnel: Paul Federspiel, Cust.
Svc., Dennis Jacque, Pres., Darwin
Radliff, Sales
Product Categories: B E F
See ad on page 25

Foley Belsaw Co., Locksmith Division
6301 Equitable Rd.
Kansas City, MO 64120
800-821-3452
816-483-2700
Fax: 816-483-5010
Key Personnel: George Doetzi, Pres.,
Chris Chrisman, Mgr. Locksmith
Supplies
Product Categories: C D F G

Fortress Safe & Lock
336 Northland Blvd.
Cincinnati, OH 45246
800-562-0295
513-772-4392

Fax: 513-772-5276
Key Personnel: Don Eveat, President,
Ron Hefflin, VP, Donna Hendrickson,
Asst. GM
Product Categories: B E F G

Fradon Lock Co., Inc.
467 Burnet Ave.
Syracuse, NY 13203
800-447-0591
315-472-6988
Fax: 315-472-0958
Key Personnel: Don Rapp, Pres., Hope
Tucker, Sales Mgr., Jim Rapp, Auto.
Sales
Product Categories: B C E F G H

Fried Bros. Inc.
467 N. 7th St.
Philadelphia, PA 19123
800-523-2924
215-627-3205
Fax: 215-592-1255
Key Personnel: Alex Ebrahimzadeh,
Pres., Sonia Starr, Purch. Mgr.
Product Categories: A B C D E F G H
Buying Group Affiliations: USCAN

Gamalski Building Specialties
3851 Auburn Rd.
Auburn Hills, MI 48326
810-852-7050
Fax: 810-852-8390
Key Personnel: Thomas C. Gamalski,
Andrew C. Gamalski, Sales Mgr., Jon
T. Gamalski, Sales Mgr.
Product Categories: B E

Garden State Hardware Wholesalers
322 W. Front St.
Planfield, NJ 07060
908-753-1343
Fax: 908-753-2040
Key Personnel:
Product Categories:

Gil-Ray Tools, Inc.

1306 McGraw St., P.O. Box 801
Bay City, MI 48707
517-892-6870
Fax: 517-892-6870
Key Personnel: David J. Deuel, Pres.,
Laurie A. Gatzka, Cust. Svc. Mgr., D.J.
Deuel, Cutter Sharp. & Sales
Product Categories: C G
See ad on page 46

Grace's Wholesale & Supply Div.
214 East 2 St.
Hastings, NE 68901-5217
402-462-2737
Key Personnel: H. Roger Grace, Prop.
Product Categories: B C D F G H

Great Lakes Lock Distributors
2310 State St.
Erie, PA 16503
800-543-8837
814-459-0546
Fax: 814-456-1542
Key Personnel: John Carneval, Owner,
John Carneval, Jr., GM, Joseph T.
Carneval, Sales Mgr.
Product Categories: B C E F H

H & H Lock & Security Wholesalers
9140 Gaither Rd.
Gaithersburg, MD 20877
800-772-9811

Product Category Key

- A — Alarms
- B — Architectural Hardware
- C — Training Manuals & Materials
- D — Locksmith Software
- E — Electronic Security Products
- F — Locking Products
- G — Locksmith Tools & Equipment
- H — Safes & Safe Products



HPC, Inc.
Designing Excellence and Manufacturing
Quality since 1956

[Click here for more information](#)

301-948-1996
Fax: 301-948-5265
Key Personnel: Paul E. Jacobson, Pres.,
Greg A. Jacobson, VP, Richard J.
Berman, Mgr.
Product Categories: B F

H. Hoffman Co.
See IDN - H. Hoffman

H. E. Mitchell Co.
118 SE 8th Ave.
Portland, OR 97214
800-626-5625
503-236-9444
Fax: 503-238-5715
Key Personnel: Judy Messing, Mike
Messing, VP, Bob Thompson, VP
Product Categories: A B C D E F G H
Buying Group Affiliations: PLUS

H.S. & S. Wholesale Dist. of Lock
Hdwe.
12911 W. 8 Mile
Detroit, MI 48235
800-342-2202
313-345-6777
Fax: 313-342-7580
Key Personnel: Michael Solomon,
Pres., Neil Cronk, Sales Mgr.
Product Categories: B D E F G H

Hans Johnsen Co.
8901 Chancellor Row
Dallas, TX 75247
800-678-1560
879-1500
Fax: 879-1530 or 800-967-4250
Key Personnel: Howard H. Johnsen,
Pres., Saul Espinoza, VP Lock
Prod./Purch., Reid Hill, Mktg. Dir.
Product Categories: A B C D E F G H
Buying Group Affiliations: USCAN
Lock Distribution Company, Inc.

Hardinge Bros. Limited
3375 14 Ave., Unit 1
Markham, Ont., Canada L3R OH2
905-470-8844
Fax: 905-470-2767
Key Personnel: Bruce Holdforth
Product Categories:

Hardware Agencies Ltd.
1220 Dundas St. East
Toronto, Ont., Canada M4M 1S3
800-268-6741
416-462-1919
Fax: 416-462-1922
Key Personnel: James Roberts, Mktg.
Mgr., Harry J. Halberstadt, GM, Jim
Roberts, Sales
Product Categories: A B C D E F G H

Hardware Sales & Supply
See IDN - Hardware Sales

Hardware Specialties, Inc.
R.D. 2, Box 28A
Dubois, PA 15801
800-872-7893
814-371-8694
Fax: 814-371-0590
Key Personnel: John T. Bricen, Pres.,
Edward Blade, Estimator, Craig
Dempsey, Purch. Agent
Product Categories: A B E F
Branches:
State College, PA
814-234-1897, 814-234-1901

Hardware Suppliers of America, Inc.
(HSI)
213 Mill Street
Winterville, NC 28590
800-334-5625
919-355-9400
Fax: 800-334-5635
Key Personnel Francis J. Casey -
President, Sanda Godwin - Customer
Service Manager
Product Guide: B F

Branches:
Irving, TX
800-334-5625
214-534-4559

Oldsmar, FL
800-282-8499
813-855-4849

Cumming, GA
800-358-6016
404-889-8944

Mansfield, OH
800-334-5625
419-747-2274

Fresno, CA
800-334-5625
209-441-0771

Hartwell Commercial Division
620-A South Jefferson St.
Placentia, CA 92670
714-993-4200
Fax: 714-777-4031
Key Personnel: Tom Huck, Nat'l. Sales
Mgr.
Product Categories:

Helen's Wholesale Locksmith Supplies
1145 St. Jude Dr.
Schenectady, NY 12303-3372
Key Personnel: Helen K. Frier,
Owner/Operator, Donald E. Frier, Sr.,
Asst.
Product Categories: D F G

Herbert Flake Co.
5005 I-45 South (Gulf Freeway)
Houston, TX 77023
800-231-4105
713-926-3200
Fax: 713-926-3399
Key Personnel: Dan Floeck, Pres., Jerry
Hardt, Pres., Joe Chambers, Sales
Mgr.
Product Categories: B C D E F G H

HMC, Int'l Div., Inc.
5996 S. Crocker St.
Littleton, CO 80120-2054
800-848-4912 ext. 4452
303-794-2510
Fax: 303-794-3703
Key Personnel: Tito Howard, Pres., P.J.
Howard, VP
Product Categories: B G

Howard Sales Co.
4625 Ripley Dr.
El Paso, TX 79922
800-456-4625
915-833-7733
Fax: 915-833-7770
Key Personnel: Bill Uhling
Product Categories: B E F G

**International Distribution
Network, Inc.**

Corporate Headquarters
1000 S. Main Ste. 280
Grapevine, Texas 76051
817-421-5470
Fax: 817-421-5468
Officers Mike Groover - President, Al
Hoffman - Vice President, Viril Mullins -
Sec./Treas.

See ad on page 91

IDN Distribution Centers:

IDN - Acme, Inc.
PO Drawer 13748
New Orleans, LA 70185
800-788-2263
504-837-7315
Fax: 504-837-7321
Key Personnel Eric Folse - President,
Jay Dennis - Sales Manager, Wayne
Hillard - Marketing Manager
Product Guide: A B C D F G H

IDN - Acme Branches:

Fort Worth, TX
800-859-2263
817-284-5696
Fax: 817-284-3501



Installation Tools
The Professionals Choice

[Click here for more information](#)



*ASP - Your Auto Service
Center for the World*

[Click here for more information](#)

Houston, TX
800-359-2263
713-668-0022
Fax: 713-668-8050

Richardson, TX
214-664-1240
Fax: 214) 664-1252

San Antonio, TX
210-545-3396
Fax: 210-545-2198

Oklahoma City, OK
405-942-8750
Fax: 405-942-0523

Phoenix, AZ
800-525-3131
602-263-5286
Fax: 602-241-0249

Denver, CO
800-445-4008
303-294-0567
Fax: 303-292-4569

IDN - Armstrong's, Inc.
1440 Dutch Valley Pl.
Atlanta, GA 30324
800-726-3332
404-875-0136
Fax: 404-888-0834
Key Personnel Viri Mullins - President,
Wade Mullins - Vice President, Sammy
Cox - Sales & Marketing Manager
Product Guide: A B C E F G H

IDN - Armstrong's Branches:

Jacksonville, FL
800-341-7857
904-387-0663
Fax: 904-387-4568

N. Miami Beach, FL
800-827-3332
305-651-1598
Fax: 305-652-1709

Norfolk, VA
800-735-3334
804-853-0611
Fax: 804-853-1832

Orlando, FL
800-775-1220
407-297-7722
Fax: 407-297-9522

Tampa, FL
800-829-3332
813-886-8007
Fax: 813-886-5696

IDN - Canada
70 Floral Parkway
Toronto, Ontario M6L 2C1
Canada
800-268-1306
416-248-5625
Fax: 416-248-9945
Key Personnel Steve Dyson - President,
Steve Whittenberg - Sales Manager,
Stewart Ellis - Marketing Manager
Product Guide: A B C E F G H

IDN - Canada Branches:

Ottawa Ont.
613-749-2172
Fax: 613-749-6651

Calgary Alberta
800-813-5344
403-291-4844
Fax: 403-291-4893

Edmonton Alberta
403-944-0014
Fax: 403-944-0929

IDN - H. Hoffman, Inc.
7330 W. Montrose Avenue
Chicago, IL 60634
800-323-1918
708-456-4300
Fax: 708-456-0878
Key Personnel Al Hoffman - President,
Karen Hoffman Kahl - Vice President,
Marty Jalove - Marketing Manager,
Dick Lux - Sales Manager
Product Guide: A B C E F G H

IDN - H. Hoffman Branches:

Cincinnati, OH
800-457-3963
513-271-8530
Fax: 513-271-8567

Davenport, IA
800-391-4633
319-391-8366
Fax: 319-391-7949

Indianapolis, IN
800-382-9449
317-635-8100
Fax: 317-637-2358

Menomonee Falls, WI
800-472-9191
414-252-4414
Fax: 414-252-4376

Valley View, OH
800-247-8217
216-642-3700
Fax: 216-642-3901

Overland Park, KS
800-526-5897
913-599-4111
Fax: 913-599-4160

St. Louis, MO
800-392-1303
314-426-6309
Fax: 314-426-6389

IDN - Hardware Sales, Inc.
35950 Industrial Road
Livonia, MI 48151
800-521-0955
313-591-1150
Fax: 313-591-7289
Key Personnel Arnie Goldman -
President, Fred Strasberger - Marketing
Manager, Ken Heeren - Sales
Manager
Product Guide: A B C E F G H

IDN - Hardware Sales, Inc. Branches:

Pittsburgh, PA
800-837-5625
412-771-6122
Fax: 412-771-6350

Ferndale, MI
800-468-7490
313-546-9866
Fax: 313-545-0627

Grand Rapids, MI
800-244-2444
616-534-7067
Fax: 616-534-1904

IDN - M. Taylor, Inc.
5635-45 Tulip Street
Philadelphia, PA 19124
800-233-3355
215-288-5588
Fax: 215-288-2511
Key Personnel Don Amole - President,
Matt Helms - Sales Manager
Product Guide: A B C E F G H

Independent Hardware Inc.
14 S. Front St.
Philadelphia, PA 19106
800-346-9464
215-925-5306
Fax: 215-922-6552
Key Personnel: Frank Stanco, Pres.,
Vincent Campagna, VP
Product Categories: B E F G

Product Category Key

- A — Alarms
- B — Architectural Hardware
- C — Training Manuals & Materials
- D — Locksmith Software
- E — Electronic Security Products
- F — Locking Products
- G — Locksmith Tools & Equipment
- H — Safes & Safe Products

It's your
reputation.



STRATTEC™

Trust the
original.

[Click here for more information](#)

Intermountain Lock & Supply

P.O. Box 65271
3106 S. Main
Salt Lake City UT 84165-0271
(800) 453-5386
(801) 486-0079
Fax: (801) 485-7205
Key Personnel: Jay Hickenlooper,
Pres., Bob Steinman, VP, Lenny Guida,
Mgr.

Product Categories: A B C D E F G H

Branches:

Denver, CO
(800) 323-8046
(303) 698-1898
Fax: (303) 698-2094
See ad on page 79

International Door Closers, Inc.
1920 Air Lane Dr.
Nashville, TN 37210
800-225-6737
615-885-7060
Fax: 615-885-0903
Key Personnel: David Minton, GM
Product Categories: B F

Island Pacific Distributors, Inc.
1668 King St.
Honolulu, HI 96826
808-955-1126
Fax: 808-946-6480
Key Personnel: Leon Wolfley, Pres.,
Barbara Wolfley, VP, Earl Tokuda,
Sales Mgr.
Product Categories: A B E F G H

J & J Distributors
1028 Donaldson
San Antonio, TX 78228
210-734-6165
Fax: 210-735-2248
Key Personnel: Joe Sulsar, Owner,
Melody L. Shaw, Office Mgr.
Product Categories: C F G

J & M Distributing
P.O. Box 18-032
Chicago, IL 60618-0032
800-645-0040
312-583-8787
Fax: 312-583-0040
Key Personnel: Richard Jakubowski
Product Categories: G

**J. Nathan Hardware
Specialties Inc.**
161 Comfort St.
Rochester, NY 14620
800-634-2580
716-325-3330
Fax: 716-325-7196
Key Personnel: Jim Bono, Pres., Mark
Putnam, Cust. Svc. Mgr., John Lupiani,
Sales Mgr.
Product Categories: A B C D E F G
Branches:
Victor, NY
716-325-3330
See ad on page 64

Jack Stearman Ltd.
338 West 6th Ave.
Vancouver, B.C., Canada V5Y 1K9
604-872-8415
Fax: 604-875-9174
Key Personnel: John Stearman, Pres.,
Edna Nichols, John Stearman, Jr.
Product Categories: B C D E F G H
Buying Group Affiliations: UsCan

Jim Ripley's Services, Inc.
304 S. Lynn Riggs Blvd.
Claremore, OK 74017
918-341-1077
Key Personnel: Jim Ripley, Pres., James
Ripley, Serviceman
Product Categories: G

ILM Wholesale, Inc.
3095 Mullins Ct.
Oxford, MI 48371
800-522-2940
810-628-6440
Fax: 800-782-1160
Key Personnel: Janet Mirku, Pres.,
Raymond Baldwin, VP, Kenn
Andridge, Sales Mgr.
Product Categories: B E

Jo-Van Distributors
929 Warden Ave.
Scarborough, Ont., Canada M1L
4C6
800-268-5731
416-752-7210
Fax: 800-286-5010
Key Personnel: Leonard J. Passarello,
CPL
Product Categories: A B C D E F G
Buying Group Affiliations: USCAN

Johansson Wholesale
12109 Glenciff Circle
Tampa, FL 33626
800-854-3320
813-854-3320
Fax: 800-808-2281
Key Personnel: Linnea Johansson, VP,
Rick Johansson, Pres., Lori Lukas
Product Categories: A B E F

K & K Supply, Inc.
20 N. Central Ave.
Upland, CA 91786
800-233-7772
909-920-0023
Fax: 909-920-0402
Key Personnel: Donald Pinnit, Pres.,
Michael C. Leon, Reg. Sales Mgr.
Product Categories: E F G H

Kenco Supply Co.
2531 North 85th St.
Omaha, NE 68134
800-228-2266
402-397-8291
Fax: 800-228-4175
Key Personnel: Bob Kent, Pres., Randy
Polson, VP, Steve Thillander,
Warehouse Mgr.
Product Categories: B C D E F G H
See ad on page 44

Key Hardware Company
3243 San Fernando Road
Los Angeles, CA 90065
213-255-9873
Fax: 213-255-8457
Key Personnel: Gil Gram, Branch
Manager
Product Categories: B C D E F G H
Buying Group Affiliations: UsCan

Key Mart Inc.
3010 SE Monroe St.
Stuart, FL 34997
800-228-7755
407-283-8029
Fax: 407-220-7920
Key Personnel: Ernie Stephan, CEO,
Ken Stephan, VP
Product Categories: B F H

Key Sales & Supply Co.
9950 Freeland Ave.
Detroit, MI 48227
800-445-KEYS (5397)
313-931-7720
Fax: 313-931-7758
Key Personnel: Sheldon Wiener, Pres.,
Michael Wiener, VP
Product Categories: A B C D E F G H

Key Supply
362 7th St.
San Francisco, CA 94103
415-626-2526
Fax: 415-626-4598

Keys Plus Distributing
454 Young St.
Tonawanda, NY 14150
716-743-0220
Key Personnel: Paul J. Ferretti, Owner
Product Categories: F G

Keys Wholesale Distributors
P.O. Box 498
Drexel Hill, PA 19026
800-292-5397
610-626-4787
Fax: 610-626-4189
Key Personnel: Bill Kline, Owner,
Dottie Kline, Sec.
Product Categories: B C D F G

Keystone Safe Distributors
3015 Philmont Ave.
Huntingdon Valley, PA 19006
800-755-2893
215-947-6330
Fax: 215-627-6419
Key Personnel: Edward C. Dornisch,
Pres.
Product Categories: E F H

Kolson, Inc.
653 Middle Neck Rd.
Great Neck, NY 11023
800-783-1335
516-487-1224
Fax: 516-487-1231
Key Personnel: Dale Kolson, VP, Sandy
Lamberg, GM, Addie Finn, Wholesale
Div. Mgr.
Product Categories: B D F

Kramer Boys Locksmith Supply

1602 E. State St.
Trenton, NJ 08609
800-222-2692
609-586-0642
Fax: 609-586-0512
Key Personnel: Adam Kramer, Scott
Kramer, VP, Robert Kramer, Sec.
Product Categories: A B C E F G H
See ad on page 61

LDM Enterprises, Inc.
1125 Linderocyn Rd. #A8221
Westlake Village, CA 91362
800-451-5950
Fax: 818-706-8560
Key Personnel: Leslie Medina
Product Categories: C D F G

LifeSaver Protection System
35246 US 19 North #123
Palm Harbor, FL 34684
813-942-3837
Fax: 813-843-0500
Key Personnel: Neal Allen
Product Categories:

Lock Wise Security Products
2001 NW 167 St.
Miami, FL 33056
800-447-6616
305-625-5525
Fax: 305-623-9564
E Mail: lockwise@aol.com.
Key Personnel: Fred Cohen, Syd
Friedman
Product Categories: B C D E F G H

Lockmasters Inc.
5085 Danville Rd.
Nicolasville, KY 40356
800-654-0637
606-885-6041
Fax: 606-885-7093
Key Personnel: J. Clayton Miller, Pres.,
Mark C. Miller, VP Sales & Mktg.,
Wesley Day, VP of materials
Product Categories: C E F G
See ad on page 42

Locks Co.
2050 NE 151 St.
N. Miami, FL 33162
800-288-0801
305-949-0700
Fax: 305-949-3619
Key Personnel: Milton Dorn, Pres.,
Mark Dorn, VP, Mike Dorn, GM
Product Categories: B C D E F G H
Buying Group Affiliations: P.L.S.

Product Category Key

- A — Alarms
- B — Architectural Hardware
- C — Training Manuals & Materials
- D — Locksmith Software
- E — Electronic Security Products
- F — Locking Products
- G — Locksmith Tools & Equipment
- H — Safes & Safe Products

Continued on page 20

medeco[®]
HIGH SECURITY LOCKS

[Click here for more information](#)

**The market leader
in locking systems
for security, safety,
and control.**



We have it all.

Quality, Value,
& Service.

[Click here for more information](#)

Continued from page 18

M. Shepse Co. Div. American Bionics
21st and East Carson Sts.
Pittsburgh, PA 15203
800-666-6007
412-381-4900
Fax: 412-381-5122
Key Personnel: Sanford Zarembeg, VP
Product Categories: A B D E F G H

M. Taylor Inc.
See IDN - M. Taylor

Major Lock Supply
2512 E. Fender Ave., Suite F
Fullerton, CA 92631
714-447-8363
Fax: 714-447-8393
Key Personnel: Ken Jordan, President,
Bob Lange, General Manager
Product Categories: B C D E F G H
Buying Group Affiliations: UsCan

Mark Bates Associates
2140 Megee Ln.
Nicholasville, KY 40356-9525
800-555-4471
606-858-0811
Fax: 606-858-4292
Key Personnel: Mark Bates, Paula
Bates
Product Categories: C G

Mayflower Sales Co., Inc.
614 Bergen St.
Brooklyn, NY 11238
800-224-2052
718-622-8785
Fax: 718-789-8346
E Mail: pilgrim@trilogy.net world wide
web(www)
Key Personnel: Bill Swetow, Pres., Paul
Swetow, VP, Brian O'Dowd, Mgr.
Lock Division
Product Categories: B C D E F G H
See ad on page 141

Maziuk & Co., Inc.
1251 W. Genesee St.
Syracuse, NY 13204
800-777-5945
315-474-3959
Fax: 315-472-3111
Key Personnel: Stanley Maziuk, Jr.,
Pres., Stanley J. Maziuk, Sr., Treasurer
Product Categories: B C D E F G H
Buying Group Affiliations: Plus
Distribution Group
Branches:
Buffalo, NY
716-684-9133, 716-684-5192

McDonald Dash Locksmith Supply, Inc.
5767 E. Shelby Dr.
Memphis, TN 38141-6804
800-238-7541
901-797-8000
Fax: 901-366-0005
E Mail: jimdt@aol.com
Key Personnel: Bert Ferguson, Pres.,
Bette F. Arndt, Exec. VP, Jim Thomas,
VP/GM
Product Categories: A B C D E F G H

McManus Locksmith Supply, Inc.
1309 Central Ave.
Charlotte, NC 28205
NC 800-432-6342, SC 800-438-
6567
704-333-9112 or 704-333-0556
Fax: 704-332-8664
Key Personnel: John W. Dyson, Pres.,
Benjamin O. Lewis, VP, Betty M.
Lewis, Sec., Treas. Mgr.
Product Categories: B C D E F G H

Meister Atlanta Corp.
3673 Clairmont Rd.
Atlanta, GA 30341
404-451-5305
Key Personnel: Renate Dellefs, Sec.
Product Categories: F

Metro Safe Co., Inc.
30845 John R
Madison Heights, MI 48071
800-541-8050
810-585-7230
Fax: 810-755-1760
Key Personnel: Orest Kalba, Pres.,
John Szechowycz, VP
Product Categories: H
Branches:
Warren, MI
810-755-3570

Micro Affiliates
5901 Montrose Rd., Ste. S1605
Rockville, MD 20852
800-430-1099
301-881-4115
Fax: 301-881-0340
Key Personnel: Norm Selinger
Product Categories: B

Mid-South Locksmith Supply
4176 New Getwell Rd.
Memphis, TN 38116
800-238-6166
901-795-6987
Fax: 901-795-3475
Key Personnel: Don Chandler, Bill
Chandler, Sales
Product Categories: B C D E F G H

Midland Land Mobile Radio
1690 N. Topping Ave.
Kansas City, MO 64120
800-MIDLAND x1690
816-241-8500 x 1690
Fax: 816-920-1144
Key Personnel:
Product Categories: E

Midwest Safe Distributors
P. O. Box 5310
Philadelphia, PA 19142
800-713-7233
Fax: 800-355-1195
Key Personnel: Lynn Gray, Sales Mgr.
Product Categories: H

Midwest Wholesale Hardware
5121 Front St.
P.O. Box 34221
Kansas City, MO 64120
800-821-8527
816-241-5663
Fax: 800-621-6581
Key Personnel: Ed Nettles, President,
Bob England, GM Kansas City, Jim
Lee, GM Orlando
Product Categories: B E F
Branches:

Orlando, FL
407-661-1140
800-659-8527
800-659-6581
See ad on page 58

Monaco Lock Company, Inc.
339-345 Newark Ave.
Jersey City, NJ 07302
800-526-6094
Fax: 800-845-LOCK
E Mail: (Internet) monacolock @
aol.com.
Key Personnel: Nancy Juskey, Sales
Rep., Barbara Garrelson, Sales Rep.
Product Categories: A B E F
See ad on page 93

National Sales & Mktg. Inc.
394 SW 12th Avenue
Deerfield Beach, FL 33432
407-395-4841
Key Personnel: Anthony Cutaia

New England Door Closer, Inc.
694 Union St., P.O. Box 28
West Springfield, MA 01090
800-628-1071
413-733-7889
Fax: 413-731-8368
Key Personnel: R.E. Longley, Pres.
Product Categories: B

New York Locksmith Supply Co., Inc.
1558 2nd Ave.
New York, NY 10028
212-737-0178, 914-328-1919
Fax: 212-988-9192
Key Personnel: Neal Geffner, Pres.,
Len Geffner, Sec., Barry Silver, Nat'l.
Sales Mgr.
Product Categories: F G

Norfield Industries
P.O. Box 459
Chico, CA 95927
916-342-2383
Fax: 916-342-5205
Key Personnel:
Product Categories:

Northwest Lock & Supply Co.
2300 Ferry St., P.O. Box 1384
Albany, OR 97321
800-359-9425
503-967-2749
Fax: 503-928-9338
Key Personnel: Ted Swanson, CEO,
Richard Kitchen, Sales Mgr., Steve
Swanson, GM
Product Categories: B C D E F G H

Ohio Travel Bag Mfg. Co.
6481 Davis Industrial Pkwy.
Solon, OH 44139
216-498-1955
Fax: 216-498-9811
Key Personnel: Paul Gallin, Bruce
Oppenheim, Exec. VP, Ray Patel, VP
Sales
Product Categories: F

Omaha Wholesale Hdwe.
1201 Pacific St., P.O. Box 3628
Omaha, NE 68103
800-238-4566
402-444-1673
Fax: 800-538-4566
Key Personnel: William J. Stock, Exec.
VP, Howard Westerberg, Mgr.
Product Categories: A B E F
See ad on page 14

Orchard Lock Distributors, Inc.
30 Edmund St.
Hamden, CT 06517
800-233-2146
203-865-8106
Fax: 203-624-4083
Key Personnel: William Simmons,
Nat'l. Sales Mgr., Paul Douglass, Reg.
Acct. Exec., Michael Jenoint, Reg.
Acct. Exec.
Product Categories: B C F G H
See ad on page 183

Orion Pacific Trading Company
3972 Barranca Pkwy., J323
Irvine, CA 92714
714-830-2003
Fax: 714-830-5668
Key Personnel: J. Bruce Such, Pres.,
Vincent Chan, VP
Product Categories: F

Outwater Plastic Industries
4 Passaic St.
Wood Ridge, NJ 07075
201-472-1174
Key Personnel: Mark Gottlieb

Pasek Corp.
9 West Third St.
So. Boston, MA 02127
800-628-2822
617-269-7110
Fax: 617-269-0547 or 800-262-
0547
Key Personnel: Lewis A. Alessandrini,
Pres.
Product Categories: A B D E F G

Patt Corp.
8111 West 47th St.
Lyons, IL 60534
800-621-4418

708-442-3901
Fax: 708-442-3907
Key Personnel: George Yurkovich,
G.M., Craig Behrendt, Sle Mgr.
Product Categories: F

Pimlico Key Service, Inc.
5254 Reisterstown Rd.
Baltimore, MD 21215
800-638-3815
410-367-7400
Fax: 410-367-7319
Key Personnel: John Trouland, Pres.
Product Categories: F G

Prime-Line Products Company
4185 Hallmark Parkway
San Bernardino, CA 92407
800-255-3505
909-887-8118
Fax: 909-880-8968
Key Personnel: Dick Crowther,
President, Dick Ugland, Director of
Sales and Marketing, Ken Dahlgren,
National Sales Manager
Product Categories: F

Protection Group, Inc.
29712 US Hwy. 19 North
Clearwater, FL 34621
813-785-0642
Fax: 813-784-9279
Key Personnel: James R. Ringold, Pres.
Product Categories: E

R & H Wholesale Supply, Inc.
1655 Folsom St.
San Francisco, CA 94103
415-863-0404
Fax: 415-863-7046
Key Personnel: Bob Heath
Product Categories:

R & S Accessories Inc.
P.O. Box 890305
Houston, TX 77289
800-338-3730
409-935-2488
Fax: 409-935-2454
Key Personnel: Roger Johnsen
Product Categories: F

R.A. Graham Co., Inc.
70 James St.
Worcester, MA 01603
800-333-3933
508-755-5815
Fax: 508-755-6584
Key Personnel: Andy Graham, VP,
Barry Graham, VP, Bob Combs, GM
Product Categories: B F
See ads on pages 46 & 47

RA-Lock Company
210 S. Clark Rd., Ste. B
Cedar Hill, TX 75104
800-777-6310
214-291-1301
Fax: 214-291-1346
Key Personnel: J.J. Gage, Pres., David
Price, VP Sales Mgr., Wesley
Reynolds, Order Svc.
Product Categories: F
See ad on page 74

Renaud Sales Canada Corp.
45B West Wilmot St., Suite 202
Richmond Hill, Ont., Canada L9T 5B4
905-707-0090
Fax: 800-791-8130
Key Personnel: K. Larry Renaud, Pres.
Product Categories: B F

Product Category Key

- A — Alarms
- B — Architectural Hardware
- C — Training Manuals & Materials
- D — Locksmith Software
- E — Electronic Security Products
- F — Locking Products
- G — Locksmith Tools & Equipment
- H — Safes & Safe Products



***SRI and Steve
Young are working
together to bring
you the best in
locksmith tools
and supplies.***

[Click here for more information](#)

Richardson Electronics, Ltd.
40W267 Keslinger Road
La Fox, IL 60147
800-348-5580
708-208-2200
Fax: 708-208-2550
E Mail: <http://www.rell.com>
Key Personnel: Edward J. Richardson,
CEO, William Garry, CEO, Joseph
Grill, VP Human Resources
Product Categories: A E

Richmond Industrial Supplies
68 Port Richmond Ave.
Staten Island, NY 10302
800-462-9997
718-448-2100
Fax: 718-981-5665
Key Personnel: Bob, Kevin, Sales,
Dan, Sales
Product Categories: B

Rininger Lock & Supply
3468 Citrus St., Ste. C
Lemon Grove, CA 91945
619-463-0170
Fax: 619-697-2590
Key Personnel: Chuck Rininger,
Owner, Brian J. Goonan, Purch. Sales
Product Categories: B C D E F G H

Robert Skeels & Company
19216 S. Laurel Park Rd.
Compton, CA 90220
800-734-4539
310-639-7240
Fax: 310-639-7569
Key Personnel: Kenneth Jordan, Pres.,
Bob Lange, GM
Product Categories: B C D E F G H
Buying Group Affiliations: Uscan

Rolland Safe Company
3130 Towerwood Dr.
Dallas, TX 75234
214-243-3711
Key Personnel: Richard Rolland
Product Categories:

Rudy's
4086 East 71st St.
Cleveland, OH 44105
800-248-7839
216-641-7711
Fax: 216-641-0060
Key Personnel: Rudy Rosales, Pres.,
Norm Farren, Mgr., Gwynne Steel,
Dept. Head
Product Categories: F

S & J Products & Services
11 S 3rd St.
Yakima, WA 98902
800-735-1797
509-575-1797
Fax: 509-575-1875
Key Personnel: Jack Baugher
Product Categories: A E H

Safemasters Company, Inc.
2700 Garfield Avenue, Suite 200
Silver Spring, MD 20910
800-633-9977
301-608-9000
Fax: 800-233-2454
Key Personnel Robin Scheirer -
President, Henry Raymond - Vice
President, Jay Von Runnen - Dir. of Ind.
Sales
Product Guide: A B C D E F H

Branches:
Silver Spring, MD
301-565-2100

Baltimore, MD
410-624-3300
Alexandria, VA
703-354-8700

Chesapeake, VA
804-420-0404

Norfolk, VA
804-627-1485

Philidelphia, PA
215-561-6464

Barrington, NJ
609-547-4706

Pittsburgh, PA
412-821-5166

Wilmington, DE
302-478-5204

Des Plaines, IL
708-299-3420

Chicago, IL
312-627-1440

Boston, MA
617-423-4846

Silver Spring, MD
301-608-9000
See ad on page 75

Secure Industries, Inc.
9 Kuhl Ave.
Hicksville, NY 11801
800-999-2534
516-433-0033
Fax: 516-433-8804
Key Personnel: Joel Kramer, Pres.,
Sadie Kramer, VP Sales
Product Categories: B F G

Security Equipment Supply
4132 Shoreline Dr., Ste. E
Earth City, MO 63045
800-325-0221
314-298-8930
Fax: 314-298-8962
Key Personnel: Bob Van Dillen, Pres.,
George Trussler, Sales Mgr.
Product Categories: A E

Branches:

Kansas City, KS
(800) 779-2865
Fax: (913) 599-3716

Chicago, IL
(800) 729-1306
Fax: (708) 803-2143

Detroit, MI
(800) 548-0680
Fax: (810) 543-5576

Memphis, TN
(800) 475-4850
Fax: (901) 365-8356

See ad on page 18

Security House Padlock Distributors
665 Milway Ave., Unit 48
Concord, Ont., Canada L4K 3T8
800-567-5300 "Canada wide"
905-669-5300
Fax: 905-660-6313
Key Personnel: J.W. (Jim) Flewitt, Pres.,
John Callaghan, VP Purch./Oper.,
Orest Drohobycky, Sales Coord.
Product Categories: A B E F

Security Lock Distributors
59 Wexford St., P.O. Box 815
Needham Heights, MA 02194
800-847-5625
617-444-1155
Fax: 800-878-6400
E Mail: seclock@ix.netcom.com
Key Personnel: Sidney Schwartz, Pres.,
David Schwartz, VP, Jeffrey Schwartz,
VP
Product Categories: B E F G

Branches:
Pompano Beach, FL
800-562-5720, 800-246-9115
See ad on page 121

Security Plus
3612 N. 16th St.
Phoenix, AZ 85016
800-426-0200
602-234-3883
Fax: 602-234-3882
Key Personnel: Steve Marcou, Theo G.
Nielson, Sales Mgr.
Product Categories: B C D E F G H

Sentinel Wholesale Hdwe. Sen. Div.
Ind.
2043 Wellwood Ave.
E. Farmingdale, NY 11735-1283
800-526-9000
516-753-6000
Fax: 516-753-6004
Key Personnel: Alan Litroff
Product Categories: B E F G

Sentry Security Fasteners, Inc.
8109 N. University
Peoria, IL 61615
309-693-2800
Fax: 309-693-2872
Key Personnel: Thomas E. Ferre, Pres.,
Stephen P. Cramer, VP
Product Categories: F G

Septon Inc.
6071 Malden Turnpike
Maden-On-The-Hudson, NY 12453
800-537-8752
914-246-0638
Fax: 914-246-3416
Key Personnel: Richard Septon, Pres.,
Ethel Wynne, Secretary
Product Categories: B C F G

Serrubec Inc.
2073 Chartier Ave.
Montreal, Dorval, Canada H9P 1H3
800-361-0243
514-631-6791
Fax: 514-631-0494
Key Personnel: Joseph Mastro, VP, A.
Huns, Controller, S. Levavallier, Sales
Coord.
Product Categories: A B C D E F G

Shield Supply & Services Ltd.
Unit 17-1391 St. James St.
Winnipeg, Man., Canada R3H 0Z1
204-774-1921
Fax: 204-774-5627
Key Personnel: C.M. "Coley"
Kaufman, Pres., Shawn McIntosh,
Sales Mgr.
Product Categories: A B C D E F G H

Silver Sales
2701-C W. 15th St., Ste. 291
Plano, TX 75075
800-258-5625
214-867-4545
Fax: 214-618-1897
Key Personnel: Judee Silver, Pres., Bill
Silver, VP, David Silver, VP Sales
Product Categories: B F
See ad on page 71

Slide Lock Tool Co., Inc.
Attn: Z-Tool Division
1166 Topside Rd.
Louisville, TN 37777
800-336-8812
615-577-8470
Fax: 615-577-5936
Key Personnel: Scott Selby, Elaine
Selby
Product Categories: C G
**See ad insert between pages
84 & 85**

So-Cal Lock & Supply
2104 Wilson Ave., Suite B
National City, CA 91950-6555
800-521-3551
619-474-8847
Fax: 619-474-2440
Key Personnel: Lin Erbland, Pres., Ron
Erbland, Sec., Tim Davis, VP
Operations
Product Categories: F G

Southern Lock & Supply Co.
10910 Endeavor Way, PO Box 1980
Pinellas Park, FL 34664
800-282-2837
813-541-5536
Fax: 800-447-2299
Key Personnel Marvin Cutson - CEO,
Dave Matthes - President, Ed Pageau -
Vice President of Sales
Product Guide: A B C D E F G H
Buying Group Affiliations: PASS

Branches:

Miami, FL
305-885-5779
Fax: 305-885-8798

Oakland Park, FL
305-568-9669
Fax: 305-568-3397

Charlotte, NC
704-527-6777
Fax: 704-527-0058

Atlanta, GA
404-455-9233
Fax: 404-455-3969
See ad on page 65

Space Age Locksmith Supplies, Inc.
138 W. Beresford Ave., Suite D
Deland, FL 32720
800-247-7942
904-734-3113
Fax: 904-734-0559
Key Personnel: John Millan, Pres.
Product Categories: C F

Standard Wholesale Hardware Inc.
42 Ludlow St.
New York, NY 10002
800-543-5625
212-353-0450
Fax: 212-420-9892
Product Categories: B C E F G H

Stears Locksmith Supply co.
34 Long Island Ave.
Sag Harbor, NY 11963
516-725-3273 or 516-725-8151
Fax: 516-725-7483
Key Personnel: Donna Stears, Road
Mgr., Paul Willinham, Head of Sales
Product Categories: B F G

Stone & Berg Wholesale Locksmith
Supply
99 Stafford St.
Worcester, MA 01603
800-225-7405
508-753-3551
Fax: 800-535-5625
Key Personnel: Rick Brown, GM, Phil
Sandstrom, Purch. Mgr., Doug Brooks,
Acct. Mgr.
Product Categories: B C D E F G H

Strauss Safe & Lock Co., Inc.
1801 2nd Ave., P.O. Box 716
Des Moines, IA 50314
800-532-4107
515-288-9571
Fax: 515-288-9752
Key Personnel: Dan Swift, Pres., Bill
Cunningham, Purch., Todd Ferris,
Sales
Product Categories: F G H

Taylor Security & Lock Co., Inc.
8585 Atlas Dr.
Gaithersburg, MD 20877-4186
800-676-7670
301-948-7670
Fax: 301-948-1029
Key Personnel: Joel Taylor, Pres.,
Richard Hageman, Sales Mgr., Chris
Gresh, Acct. Mgr.
Product Categories: B D E F G H

The Locksmith Store, Inc.
1229 E. Algonquin Rd., Unit E
Arlington Heights, IL 60005
708-364-5111
Fax: 708-364-5125
Key Personnel: Tom Swiderek,
President, Bob Szabo, Customer Svc.,
Jack Swiderek, Customer Svc.
Product Categories: D F G

The National Locksmith
1533 Burgundy Parkway
Streamwood, IL 60107
708-837-2044
Fax: 708-837-1210
E Mail: AOL Natl Lock, Internet
natlock@aol.com
Key Personnel: Marc Goldberg,
Editor/Publisher
Product Categories: C

The Peterzell Co.
P.O. Box 521357
Longwood, FL 32752-1357
407-830-1171
Fax: 407-830-1172
Key Personnel: Victor Peterzell, Pres.
Product Categories:

The Power Company
429 Fairview Ave. N.
Seattle, WA 98109
206-624-5090
Fax: 206-624-5214
Key Personnel: Bill Connors, CEO,
Claudette, Sales, Tony, GM
Product Categories: G

Timemasters
2604 SW 17th St.
Topeka, KS 66604
913-232-8705
Fax: 800-798-TIME
Key Personnel: Dan Graffeo
Product Categories: C E F G H

Top Notch Distributors
413 Erie St.
Honesdale, PA 18431
800-233-4210
717-253-LOCK (5625)
Fax: 800-854-4146
Key Personnel: Brian Mikulewicz,
Mgr., Jim Williams, Mgr. (NV)
Product Categories: B F
Branches:
Carson City, NV
800-722-4210, 702-885-0440,
800-248-3620
See ads on pages 9 & 129

TRAM International Inc.
P.O. Box 6247
Delray Beach, FL 33482-6247
800-843-2440

407-637-0123
Fax: 800-448-8280
Key Personnel: Jacki Friedman, Sales
Rep.
Product Categories: F

Transwest Hardware Sales
1315 Powell St.
Vancouver, B.C., Canada V5L 1G8
800-567-1177
604-253-0017
Fax: 604-253-5344
Key Personnel: Dick Ballard, GM,
Brad McRitchie, Sales Coord.
Product Categories: B E F G

Turn 10 Wholesale
Mill Creek Rd., P.O. Box 746
Marietta, OH 45750
800-848-9790
Fax: 800-391-4553
Key Personnel: David Miller, Sales,
Maribeth Browne, Cust. Svc.
Product Categories: H
See ad on back cover

Tweed's Security Hardware
Wholesalers
601 Elm Ave.
Portsmouth, VA 23704
800-544-4482
804-399-2180
Fax: 804-399-1636
Key Personnel: Ernest F. Floyd, Jr.,
Pres., Gary Waterman, VP/Sales
Dept., E. Clay Floyd, VP/Service
Dept.
Product Categories: A B C E F G H

Wadsworth White Inc.
5873 New Peachtree Rd., Ste. 100
Atlanta, GA 30340
800-458-9449
404-458-9449

Fax: 404-458-2253
Key Personnel: Joe White, Sales,
Brenda Langston, Cust. Svc.
Product Categories: A B E F
See ad on page 142

Waldron's Security
90 Knox Ct.
Denver, CO 80219
800-255-0701
303-934-2148
Fax: 303-934-3452
Key Personnel: Donald N. Waldron,
Owner, Donna Waldron, Mgr., Karen
Sayers, Inside Sales
Product Categories: B F G

Wedge Co Tool Supply International
717 122 Ave. NE #4
Bellevue, WA 98005
800-452-2304
Key Personnel: Doug Kimzey, Pres.
Product Categories: G

Wholesale 4 Inc.
706 SE Grand Ave.
Portland, OR 97214
800-547-0921
503-238-8605
Fax: 503-235-5636
Key Personnel: Nancy Burt, Mgr.,
Siobham Wrog, Sales, Kevin Clark,
Sales
Product Categories: A B C D E F G H

Wilco Supply
5960 Telegraph Ave.
Oakland, CA 94609
800-745-5450
510-652-8522
Fax: 510-653-5397
Key Personnel: H.D. Williams, Pres.,
Robert D. Williams, VP/Oper. Mgr.,
Jonathan Clarner, Sec./Treas.

Product Categories: A B C D E F G H
Buying Group Affiliations: Reliable

Williams Key Co., Inc.
2206 Locust St.
St. Louis, MO 63103
314-231-2411
Fax: 314-231-4609
Key Personnel: Erma L. Williams, Pres.
Product Categories:

Yohar Supply
616 Cleveland St.
Elyria, OH 44035
216-366-5504
Key Personnel: Lloyd Lopez
Product Categories:

Zipf Lock Co.
830 Harmon Ave.
Columbus, OH 43223
800-848-1577
614-228-3507
Fax: 800-228-6320
Key Personnel: Richard Zipf, Steve Zipf
Product Categories: B C D E F G H
See ad on page 67

Product Category Key

- A — Alarms
- B — Architectural Hardware
- C — Training Manuals & Materials
- D — Locksmith Software
- E — Electronic Security Products
- F — Locking Products
- G — Locksmith Tools & Equipment
- H — Safes & Safe Products

INL

NATIONAL

AUTO LOCK SERVICE, INC.

National Auto Lock Service, Inc. offers a wide range of equipment and services for the Automotive Locksmith. From tools and hard to find key blanks to transponder programming, we can take the mystery out of car service. We accept credit card orders, and can ship COD. Contact us for the latest in automotive technology.

DISTRIBUTORS by STATE

Alabama

Brook's Lock & Key, Inc.
Decatur
800-292-5008
Fax: 205-353-8260

Arizona

American Lock & Supply, Inc.
Phoenix
800-826-6968
Fax: 602-254-0272, 800-325-3728

Clark Security Products
Phoenix
800-775-5625
Fax: 602-275-9235

IDN - Acme, Inc.
Phoenix
800-525-3131
Fax: 602-241-0249

Security Plus
Phoenix
800-426-0200
Fax: 602-234-3882

California

Acme Security Systems
San Leandro
800-348-2263
Fax: 800-435-8233

Adavco Security Products
Southgate
213-564-1662
Fax: 213-564-9622

Alarm Suppliers
S. San Francisco
415-871-7378
Fax: 415-871-7497

Alno, Inc.
Chatsworth

Am. Access Supply, LA Div.
Los Angeles
800-858-1726
Fax: 310-568-1507

American Lock & Supply, Inc.
Anaheim
800-854-8775
Fax: 714-579-7554

American Lock & Supply, Inc.
Fremont
800-227-1142
Fax: 510-651-2350, 800-662-4399

American Lock & Supply, Inc.
San Diego
800-231-8435
Fax: 800-788-0916

Anytime Security Products
Hermosa Beach
800-539-2427
Fax: 310-798-4604

Automatic Gate Wholesalers
Modesto
800-238-2301
Fax: 800-438-2301

C & M Tool
Fremont
510-792-6613

Clark Security Products
Bell
800-889-5625
Fax: 213-262-0741

Clark Security Products
San Diego
800-854-2088
Fax: 619-565-4605

Clark Security Products
San Diego
800-854-2088
Fax: 619-565-4605

Clark Security Products
W. Sacramento
800-245-3003
Fax: 916-372-7221

DiMark International
Santa Maria
800-235-2435
Fax: 805-928-8034

DRK Specialties, Keyrings & Things
Fremont
800-654-1850
Fax: 510-471-8885

Dugmore and Duncan of California
Riverside
800-325-1595
Fax: 909-360-0572

Hardware Suppliers of America, Inc.
Fresno
800-334-5625

Hartwell Commercial Division
Placentia
714-993-4200
Fax: 714-777-4031

K & K Supply, Inc.
Upland
800-233-7772
Fax: 909-920-0402

Key Hardware Company
Los Angeles
213-255-9873
Fax: 213-255-8457

Key Supply
San Francisco
415-626-2526
Fax: 415-626-4598

LDM Enterprises, Inc.
Westlake Village
800-451-5950
Fax: 818-706-8560

Major Lock Supply
Fullerton
714-447-8363
Fax: 714-447-8393

Norfield Industries
Chico
916-342-2383
Fax: 916-342-5205

Orion Pacific Trading Company
Irvine
714-830-2003
Fax: 714-830-5668

Prime-Line Products Company
San Bernardino
800-255-3505
Fax: 909-880-8968

R & H Wholesale Supply, Inc.
San Francisco
415-863-0404
Fax: 415-863-7046

Rininger Lock & Supply
Lemon Grove
619-463-0170
Fax: 619-697-2590

Robert Skeels & Company
Compton
800-734-4539
Fax: 310-639-7569

So-Cal
National City
800-521-3551
Fax: 619-474-2440

Wilco Supply
Oakland
800-745-5450
Fax: 510-653-5397

Canada

Access Safe & Supply Ltd.
Burlington, Ont.
800-268-9033
Fax: 905-319-0366

Agences W. Pelletier (1980) Inc.
Montreal, Quebec
800-363-6700
Fax: 514-276-9413

Associated Lock & Supply
Port Coquitlam, BC
800-373-5754
Fax: 604-942-3761

Cypress Security Products Ltd.
Calgary, AB
800-561-1967
Fax: 403-250-1969

Enixus Trade, Ltd.
St. Catharines, Ont.
905-682-3086
Fax: 905-682-3086

Hardinge Bros. Limited
Markham, Ont.
905-470-8844
Fax: 905-470-2767

Hardware Agencies Ltd.
Toronto, Ont.
800-268-6741
Fax: 416-462-1922

IDN - Canada
Calgary, Alberta
800-813-5344
Fax: 403-291-4893

IDN - Canada
Edmonton, Alberta
403-944-0014
Fax: 403-944-0929

IDN - Canada
Ottawa, Ontario
613-749-2172
Fax: 613-749-6651

IDN - Canada
Toronto, Ontario
800-268-1306
Fax: 416-248-9945

Jack Stearman Ltd.
Vancouver, B.C.
604-872-8415
Fax: 604-875-9174

Jo-Van Distributors
Scarborough, Ont.
800-268-5731
Fax: 800-286-5010

Renaud Sales Canada Corp.
Richmond Hill, Ont.
905-707-0090
Fax: 800-791-8130

Security House Padlock Distributors
Concord, Ont.
800-567-5300 "Canada wide"
Fax: 905-660-6313

Serrubec Inc.
Montreal, Dorval
800-361-0243
Fax: 514-631-0494

Shield Supply & Services Ltd.
Winnipeg, Man.
204-774-1921
Fax: 204-774-5627

Transwest Hardware Sales
Vancouver, B.C.
800-567-1177
Fax: 604-253-5344

Colorado

American Lock & Supply, Inc.
Denver
800-346-5549
Fax: 303-733-0202, 800-241-0202

City Lock Supply
Boulder
303-444-4407
Fax: 303-442-8380

Clark Security Products
Denver
800-282-5625
Fax: 800-699-3329

HMC, Int'l Div., Inc.
Littleton
800-848-4912 ext. 4452
Fax: 303-794-3703

IDN - Acme, Inc.
Denver
800-445-4008
Fax: 303-292-4369

Intermountain Lock & Supply
Denver
800-323-8046
Fax: 303-698-2094

Waldron's Security
Denver
800-255-0701
Fax: 303-934-3452

Connecticut

Canaan Distributors
Stamford
203-356-1000

Orchard Lock Distributors, Inc.
Hamden
800-233-2146
Fax: 203-624-4083

District Of Columbia

Blaydes Lock Co., Inc.
Washington
800-424-2650
Fax: 202-832-1359

Door Closer Service Co., Inc.
Washington
800-566-0606
Fax: 800-908-3667, 202-529-7826

Delaware

Safemasters Company, Inc.
Wilmington
302-478-5204

Florida

Atlantic Lock & Key
Hollywood
305-966-9862
Fax: 305-962-1202

Blue Dog
Altamonte Springs
800-248-2887
Fax: 407-774-6054

C.E. Sanders
Lutz
813-948-3162
Fax: 813-949-1874

Closed Circuit Designs
N. Miami Beach
800-228-8321
Fax: 305-652-3471

Dugmore and Duncan of Florida
Lakeland
800-232-1595
Fax: 813-666-5226

Hardware Suppliers of America, Inc.
Oldsmar
800-282-8499

IDN - Armstrong's, Inc.
Jacksonville
800-341-7857
Fax: 904-387-4568

IDN - Armstrong's, Inc.
N. Miami Beach
800-827-3332
Fax: 305-652-1709

IDN - Armstrong's, Inc.
Orlando
800-775-1220
Fax: 407-297-9522

IDN - Armstrong's, Inc.
Tampa
800-829-3332
Fax: 813-886-5696

Johansson Wholesale
Tampa
800-854-3320
Fax: 800-808-2281

Key Mart Inc.
Stuart
800-228-7755
Fax: 407-220-7920

LifeSaver Protection System
Palm Harbor
813-942-3837
Fax: 813-843-0500

Lock Wise Security Products
Miami
800-447-6616
Fax: 305-623-9564

Locks Co.
N. Miami
800-288-0801
Fax: 305-949-3619

Midwest Wholesale Hardware
Kansas City
800-821-8527
Fax: 800-621-6581

National Sales & Mktg. Inc.
Deerfield Beach
407-395-4841
Fax:

Protection Group, Inc.
Clearwater
813-785-0642
Fax: 813-784-9279

Southern Lock & Supply Co.
Pinellas Park
800-282-2837
Fax: 800-447-2299

Southern Lock and Supply Co.
Miami
305-885-5779
Fax: 305-885-8798

Southern Lock and Supply Co.
Oakland Park
305-568-9669
Fax: 305-568-3397

Space Age Locksmith Supplies, Inc.
Deland
800-247-7942
Fax: 904-734-0559

The Peterzell Co.
Longwood
407-830-1171
Fax: 407-830-1172

TRAM International Inc.
Delray Beach
800-843-2440
Fax: 800-448-8280

Georgia

American Lock & Supply, Inc.
Atlanta
800-952-4452
Fax: 404-458-0899, 800-358-4561

Hardware Suppliers of America, Inc.
Cumming
800-358-6016

IDN - Armstrong's, Inc.
Atlanta
800-726-3332
Fax: 404-888-0834

Meister Atlanta Corp.
Atlanta
404-451-5305

Southern Lock and Supply Co.
Atlanta
404-455-9233
Fax: 404-455-3969

Wadsworth White Inc.
Atlanta
800-458-9449
Fax: 404-458-2253

Hawaii

Island Pacific Distributors, Inc.
Honolulu
808-955-1126
Fax: 808-946-6480

Iowa

IDN - H. Hoffman, Inc.
Davenport
800-391-4633
Fax: 319-391-7949

Strauss Safe & Lock Co., Inc.
Des Moines
800-532-4107
Fax: 515-288-9752

Illinois

Alertco, Inc.
Evanston
708-869-1524

American Lock & Supply, Inc.
Elmhurst
800-621-0177
Fax: 708-832-9084, 800-238-5397



**The Innovation You
Expect, with the
Flexibility You Need!**

[Click here for more information](#)



**Make Sargent & Greenleaf's
Comptronic locks your
choice for electronic safe
locking solutions.**

[Click here for more information](#)

Anderson Lock Co.
Des Plaines
708-296-1157
Fax: 708-296-9259

Brady Office Machine Security
Chicago
800-326-8349
Fax: 312-779-9712

Clark Security Products
Wood Dale
800-755-5625
Fax: 708-350-8535

Dealer Connection, Inc.
Naperville
800-500-4500
Fax: 708-717-2805

ElJay Express
Wheeling
800-432-1311
Fax: 708-480-1383

EMG Associates
Chicago
800-468-3558
Fax: 312-649-0787

Ewert Wholesale Hardware Inc.
Alsip
800-451-0200
Fax: 708-597-0881

Express Hardware
Barrington
800-323-7447
Fax: 708-381-7199

IDN - H. Hoffman, Inc.
Chicago
800-323-1918
Fax: 708-456-0878

J & M Distributing
Chicago
800-645-0040
Fax: 312-583-0040

Patt Corp.
Lyons
800-621-4418
Fax: 708-442-3907

Richardson Electronics, Ltd.
La Fox
800-348-5580
Fax: 708-208-2550

Safemasters Company, Inc.
Chicago
312-627-1440

Safemasters Company, Inc.
Des Plaines
708-299-3420

Security Equipment Supply
Des Plaines
800-729-1306
Fax: 708-803-2143

Sentry Security Fasteners, Inc.
Peoria
309-693-2800
Fax: 309-693-2872

The Locksmith Store, Inc.
Arlington Heights
708-364-5111
Fax: 708-364-5125

The National Locksmith
Streamwood
708-837-2044
Fax: 708-837-1210

Indiana

IDN - H. Hoffman, Inc.
Indianapolis
800-382-9449
Fax: 317-637-2358

Kansas

American Lock & Supply, Inc.
Kansas City
800-888-5625
Fax: 913-432-1342, 800-395-7945

IDN - H. Hoffman, Inc.
Overland Park
800-526-5897
Fax: 913-599-4160

Security Equipment Supply
Lenexa
800-779-2865
Fax: 913-599-3716

Timemasters
Topeka
913-232-8705
Fax: 800-798-TIME

Kentucky

Lockmasters Inc.
Nicholasville
800-654-0637
Fax: 606-885-7093

Mark Bates Associates
Nicholasville
800-555-4471
Fax: 606-858-4292

Louisiana

IDN - Acme, Inc.
New Orleans

800-788-2263
Fax: 504-837-7321

Massachusetts

American Lock & Supply
Boston
800-291-2797
Fax: 800-291-2798

Boston Lock & Safe Co., Inc.
Brighton
800-252-5757
Fax: 617-787-3425

Boyle & Chase, Inc.
Accord
800-325-2530
Fax: 617-335-5342

Clark Security Products
Auburn
800-746-5625
Fax: 800-596-5625

Commonwealth Lock Co.
Cambridge
800-442-7009
Fax: 617-661-3168

Dugmore and Duncan, Inc.
Hingham
800-225-1595
Fax: 617-740-4043

Mancini Safe Company
Cambridge
800-367-3453
Fax: 617-497-7542

New England Door Closer, Inc.
West Springfield
800-628-1071
Fax: 413-731-8368



SCHWAB CORP.

Fire protection for your vital records.

**Free freight!!
No middle man!!**

[Click here for more information](#)

Pasek Corp.
So. Boston
800-628-2822
Fax: 617-269-0547 or 800-262-0547

R.A. Graham Co., Inc.
Worcester
800-333-3933
Fax: 508-755-6584

Safemasters Company, Inc.
Boston
617-423-4846

Security Lock Distributors
Needham Heights
800-847-5625
Fax: 800-878-6400

Stone & Berg Wholesale Locksmith
Supply
Worcester
800-225-7405
Fax: 800-535-5625

Maryland

American Lock & Supply, Inc.
Elkridge
800-358-6398
Fax: 410-379-5990, 800-358-6399

Capitol Lock Co., Inc.
College Park
301-513-9500
Fax: 301-513-9505

Clark Security Products
Lanham
800-578-5625
Fax: 800-378-5625

Doorguard Systems, Inc.
Columbia
301-498-7200

H & H Lock & Security Wholesalers
Gaithersburg
800-772-9811
Fax: 301-948-5265

Micro Affiliates
Rockville
800-430-1099
Fax: 301-881-0340

Pimlico Key Service, Inc.
Baltimore
800-638-3815
Fax: 410-367-7319

Safemasters Company, Inc.
Baltimore
410-624-3300

Safemasters Company, Inc.
Silver Spring
301-608-9000

Safemasters Company, Inc.
Silver Spring
800-633-9977
Fax: 800-233-2454

Taylor Security & Lock Co., Inc.
Gaithersburg
800-676-7670
Fax: 301-948-1029

Michigan

A.T. Jones & Son
Detroit
800-735-4570
Fax: 313-965-1093

Anchor Safe Co.
Warren
800-541-8050
Fax: 810-755-1760

Gamalski Building Specialties
Auburn Hills
810-852-7050
Fax: 810-852-8390

Gil-Ray Tools, Inc.
Bay City
517-892-6870
Fax: 517-892-6870

H.S. & S. Wholesale Dist. of Lock
Hdwe.
Detroit
800-342-2202
Fax: 313-342-7580

IDN - Hardware Sales, Inc.
Ferndale
800-468-7490
Fax: 313-545-0627

IDN - Hardware Sales, Inc.
Grand Rapids
800-244-2444
Fax: 616-534-1904

IDN - Hardware Sales, Inc.
Livonia
800-521-0955
Fax: 313-591-7289

ILM Wholesale, Inc.
Oxford
800-522-2940
Fax: 800-782-1160

Key Sales & Supply Co.
Detroit
800-445-KEYS (5397)
Fax: 313-931-7758

Metro Safe Co., Inc.
Madison Heights
800-541-8050
Fax: 810-755-1760

Security Equipment Supply
Madison Heights
800-548-0680
Fax: 810-543-5576

Minnesota

Doyle Lock Supply, Inc.
Minneapolis
800-333-6953
Fax: 612-521-0166

E.L. Reinhardt
Vadnais Heights
800-328-1311
Fax: 612-481-0166

Missouri

Citizens Defensive Products
St. Joseph
816-233-1512
Fax: 816-233-3092

Foley Belsaw Co., Locksmith Division
Kansas City
800-821-3452
Fax: 816-483-5010

IDN - H. Hoffman, Inc.
St. Louis
800-392-1303
Fax: 314-426-6389

Midland Land Mobile Radio
Kansas City
800-MIDLAND x1690
Fax: 816-920-1144

Midwest Wholesale Hardware
Kansas City
800-821-8527
Fax: 800-621-6581

Security Equipment Supply
Earth City
800-325-0221
Fax: 314-298-8962

Williams Key Co., Inc.
St. Louis
314-231-2411
Fax: 314-231-4609

North Carolina

Action Hardware, Inc.
Charlotte
704-334-1577

C.H. Edwards, Inc.
Greenville
919-756-8500
Fax: 919-756-3884

Hardware Suppliers of America, Inc.
(HSI)
Winterville
800-334-5625
Fax: 800-334-5635

McManus Locksmith Supply, Inc.
Charlotte
NC 800-432-6342, SC 800-438-6567
Fax: 704-332-8664

Southern Lock and Supply Co.
Charlotte
704-527-6777
Fax: 704-527-0058

Nebraska

Grace's Wholesale & Supply Div.
Hastings
402-462-2737

Kenco Supply Co.
Omaha
800-228-2266
Fax: 800-228-4175

Omaha Wholesale Hdwe.
Omaha
800-238-4566
Fax: 800-538-4566

New Hampshire

Adams Lock & Safe Co., Inc.
Concord
800-635-2228
Fax: 603-226-4983

New Jersey

Accredited Lock Supply Co.
Secaucus
800-652-2835
Fax: 201-865-5031

Ace Lock & Security Supply
Union
800-223-5625
Fax: 908-688-2442

Ambassador Wholesale Safe
Distributors
Lake Hiawatha
800-999-5510
Fax: 201-402-1447

Architectural Products By Outwater,
L.L.C.
Woodridge
800-835-4400
Fax: 800-835-4403

Continued on page 30



**LOCKMASTERS
SECURITY
MANAGEMENT**

TM

*Providing quality tools,
parts, and service for the
security professional.*

[Click here for more information](#)

Continued from page 27

ASLA Distributing
East Rockaway
516-766-2863
Fax: 516-766-2863

Bell's Security Sales
Bloomfield
800-772-2266
Fax: 201-743-6357

Craftmaster Hardware Co., Inc.
Hackensack
800-221-3212
Fax: 201-646-0181

Garden State Hardware Wholesalers
Planfield
908-753-1343
Fax: 908-753-2040

Kramer Boys Locksmith Supply
Trenton
800-222-2692
Fax: 609-586-0512

Monaco Lock Company, Inc.
Jersey City
800-526-6094
Fax: 800-845-LOCK

Safemasters Company, Inc.
Barrington
609-547-4706

New Mexico

Cook's Building Specialties, Inc.
Albuquerque
505-883-5701
Fax: 505-883-5704

New York

ADI
Syosset
516-921-6704
Fax: 516-921-8118

American Lock & Supply, Inc.
Hauppauge
800-628-5625
Fax: 516-231-2019, 800-424-7185

Apex Security Hardware Corp.
Brooklyn
800-232-1117
Fax: 718-438-3327, 800-951-7000

Aristo Sales Co., Inc.
Long Island City
800-221-1322
Fax: 718-937-5794

Autotech Accessories, Inc.
Brooklyn
718-680-8901
Fax: Automatic

Avco Key Supply
Northport
800-332-5397
Fax: 800-329-5397

Barry Supply Co., Div. of Barry Ind.
Inc.
New York
212-242-5200
Fax: 212-675-7094

Buffalo Safe & Lock
W. Seneca
800-255-6257
Fax: 716-674-4645

City Intercoms, Inc.
New York
800-248-9468
Fax: 800-598-2865

Dave Sanders & Co. Inc.
New York
212-334-9898
Fax: 212-966-4185

Empire Security Supplies
Pt. Jefferson Station
516-928-1919
Fax: 516-928-4745

Fradon Lock Co., Inc.
Syracuse
800-447-0591
Fax: 315-472-0958

J. Nathan Hardware Specialties Inc.
Rochester
800-634-2580
Fax: 716-325-7196

Keys Plus Distributing
Tonawanda
716-743-0220

Kolson, Inc.
Great Neck
800-783-1335
Fax: 516-487-1231

Mayflower Sales Co., Inc.
Brooklyn
800-224-2052
Fax: 718-789-8346

Maziuk & Co., Inc.
Syracuse
800-777-5945
Fax: 315-472-3111

New York Locksmith Supply Co., Inc.
New York
212-737-0178, 914-328-1919
Fax: 212-988-9192

Richmond Industrial Supplies
Staten Island
800-462-9997
Fax: 718-981-5665

Secure Industries, Inc.
Hicksville
800-999-2534
Fax: 516-433-8804

Sentinel Wholesale Hdwe. Sen. Div.
Ind.
E. Farmingdale
800-526-9000
Fax: 516-753-6004

Septon Inc.
Maden-On-The-Hudson
800-537-8752
Fax: 914-246-3416

Standard Wholesale Hardware Inc.
New York
800-543-5625
Fax: 212-420-9892

Stears Locksmith Supply co.
Sag Harbor
516-725-3273 or 516-725-8151
Fax: 516-725-7483

Ohio

Akron Hdw. Consultants
Akron
800-321-9602
Fax: 800-328-6070

Allied Locksmith Supply
Youngstown
800-544-2102
Fax: 216-726-0865

Brondco Distributing
Cleveland
216-331-1556

Curtis Industries Inc.
Eastlake
800-555-5397

Fortress Safe & Lock
Cincinnati
800-562-0295
Fax: 513-772-5276

Hardware Suppliers of America, Inc.
Manfield
800-334-5625

IDN - H. Hoffman, Inc.
Cincinnati
800-457-3963
Fax: 513-271-8567



***HPC has it all:
Key Machines, Software, Books, Car
Openers, Pick Sets, Tools, Door
Guards, and Key Cabinets***

[Click here for more information](#)

IDN - H. Hoffman, Inc.
Valley View
800-247-8217
Fax: 216-642-3901

Ohio Travel Bag Mfg. Co.
Solon
216-498-1955
Fax: 216-498-9811

Rudy's
Cleveland
800-248-7839
Fax: 216-641-0060

Turn 10 Wholesale
Marietta
800-848-9790
Fax: 800-391-4553

Yohar Supply
Elyria
216-366-5504

Zipf Lock Co.
Columbus
800-848-1577
Fax: 800-228-6320

Oklahoma

JBrooks Supply, Inc.
Oklahoma City
800-347-4477
Fax: 405-672-7575

IDN - Acme, Inc.
Oklahoma City
405-942-8750
Fax: 405-942-0523

Jim Ripley's Services, Inc.
Claremore
918-341-1077

Oregon

Berg Wholesale Inc.
Portland
503-220-0000
Fax: 503-228-9410

H.E. Mitchell Co.
Portland
800-626-5625
Fax: 503-238-5715

Northwest Lock & Supply Co.
Albany
800-359-9425
Fax: 503-928-9338

Wholesale 4 Inc.
Portland
800-547-0921
Fax: 503-235-5636

Pennsylvania

Ace Lock, The Security People
Pittsburgh
412-363-3328

Allegheny Lock Co., Inc.
Philadelphia
215-745-1217

AmoraTech, Inc.
Shermans Dale
717-582-8114
Fax: 717-582-7549

Andrew's Wholesale Lock Supply
Lebanon
800-544-0519
Fax: 717-274-8659

Fried Bros. Inc.
Philadelphia
800-523-2924
Fax: 215-592-1255

Great Lakes Lock Distributors
Erie
800-543-8837
Fax: 814-456-1542

Hardware Specialties, Inc.
Dubois
800-872-7893
Fax: 814-371-0590

IDN - Hardware Sales, Inc.
Pittsburgh
800-837-5625
Fax: 412-771-6350

IDN - M. Taylor, Inc.
Philadelphia
800-233-3355
Fax: 215-288-2511

Independent Hardware Inc.
Philadelphia
800-346-9464
Fax: 215-922-6552

Keys Wholesale Distributors
Drexel Hill
800-292-5397
Fax: 610-626-4189

Keystone Safe Distributors
Huntingdon Valley
800-755-2893
Fax: 215-627-6419

M. Shepse Co. Div. American Bionics
Pittsburgh
800-666-6007
Fax: 412-381-5122

Midwest Safe Distributors
Philadelphia
800-713-7233
Fax: 800-355-1195

Safemasters Company, Inc.
Philadelphia
215-561-6464

Safemasters Company, Inc.
Pittsburgh
412-821-5166

Top Notch Distributors
Honesdale
800-233-4210
Fax: 800-854-4146

Trans-Atlantic Company
Philadelphia
800-523-9956
Fax: 215-629-1282

Rhode Island

Columbus Door Company
Warwick
401-781-7792
Fax: 401-467-3620

Tennessee

C&H Lock & Saw Co.
Memphis
901-682-5691

International Door Closers, Inc.
Nashville
800-225-6737
Fax: 615-885-0903

McDonald Dash Locksmith Supply, Inc.
Memphis
800-238-7541
Fax: 901-366-0005

Mid-South Locksmith Supply
Memphis
800-238-6166
Fax: 901-795-3475

Security Equipment Supply
Memphis
800-475-4850
Fax: 901-365-8356

Slide Lock Tool Co., Inc.
Louisville
800-336-8812
Fax: 615-577-5936

Texas

American Lock & Supply, Inc.
Dallas
800-292-0115
Fax: 214-358-6037, 800-527-3028

American Lock & Supply, Inc.
Houston
800-435-8105
Fax: 713-681-0850, 800-435-8232

Amos Lock & Key Supply Co.
Fort Worth
800-772-7432
Fax: 317-335-5399

Defiant Safe Co.
Dallas
800-225-2984
Fax: 214-241-7669

Edw. Saucedo & Son Co., Inc.
El Paso
800-248-3726
Fax: 915-566-8608

Fairway Supply, Inc.
Houston
800-767-3247
Fax: 713-957-2122

Hans Johnsen Co.
Dallas
800-678-1560
Fax: 879-1530 or 800-967-4250

Hardware Suppliers of America, Inc.
Irving
800-334-5625

Herbert Flake Co.
Houston
800-231-4105
Fax: 713-926-3399

Howard Sales Co.
El Paso
800-456-4625
Fax: 915-833-7770

IDN - Acme, Inc.
Fort Worth
800-859-2263
Fax: 817-284-3501

IDN - Acme, Inc.
Houston
800-359-2263
Fax: 713-668-8050

IDN - Acme, Inc.
Richardson
214-664-1240
214-664-1252

IDN - Acme, Inc.
San Antonio
210-545-3396
Fax: 210-545-2198

International Distribution Network, Inc.
Grapevine
817-421-5470
Fax: 817-421-5468

J & J Distributors
San Antonio
210-734-6165
Fax: 210-735-2248

R & S Accessories Inc.
Houston
800-338-3730
Fax: 409-935-2454

RA-Lock Company
Cedar Hill
800-777-6310
Fax: 214-291-1346

Rolland Safe Company
Dallas
214-243-3711

Silver Sales
Plano
800-258-5625
Fax: 214-618-1897

Utah

Clark Security Products
Salt Lake City
800-453-6430
Fax: 801-487-3254

Virginia

American Lock & Key Co.
Richmond
800-995-6247
Fax: 804-282-1007

Colonial Lock Supply Co., Inc.
Newington
800-732-9117
Fax: 703-550-8857

IDN - Armstrong's, Inc.
Norfolk
800-735-3334
Fax: 804-853-1832

Safemasters Company, Inc.
Alexandria
703-354-8700

Safemasters Company, Inc.
Chesapeake
804-420-0404

Safemasters Company, Inc.
Norfolk
804-627-1485

Tweed's Security Hardware
Wholesalers
Portsmouth
800-544-4482
Fax: 804-399-1636

Washington

American Access Supply
Seattle
800-559-9634
Fax: 800-243-3049

American Lock & Supply, Inc.
Seattle
800-356-5661
Fax: 206-431-8527, 800-392-1132

Clark Security Products
Seattle
800-942-5275
Fax: 800-546-5625



Every Installation
Is a Self-Portrait
Of the Person
Who Did It.
Autograph Your
Work with
Excellence.

[Click here for more information](#)

S & J Products & Services
Yakima
800-735-1797
Fax: 509-575-1875

The Power Company
Seattle
206-624-5090
Fax: 206-624-5214

Wedge Co Tool Supply International
Bellevue
800-452-2304

Wisconsin

Aetha Hardware Corp.
Milwaukee
414-445-1800

Door Hardware Distributors, Inc.
Milwaukee
800-829-8905
Fax: 414-291-5685

Fastrack Hardware, Inc.
Brookfield
800-458-8707
Fax: 800-667-8701

IDN - H. Hoffman, Inc.
Menomonee Falls
800-472-9191
Fax: 414-252-4378

Paneff
Milwaukee
800-448-1247
Fax: 414-462-0980



ASP Covers
the World of
Auto Locks

[Click here for more information](#)

DISTRIBUTORS by PRODUCT

Alarms

Accredited Lock Supply Co.
Secaucus, NJ
800-652-2835
Fax: 201-865-5031

Ace Lock & Security Supply
Union, NJ
800-223-5625
Fax: 908-688-2442

Acme Security Systems
San Leandro, CA
800-348-2263
Fax: 800-435-8233

Acme Wholesale Dist. -See IDN

Agences W. Pelletier (1980) Inc.
Montreal, Quebec, Canada
800-363-6700
Fax: 514-276-9413

Armstrong's Lock & Supply Inc. - See IDN

Associated Lock & Supply
Port Coquillam, BC, Canada
800-373-5754
Fax: 604-942-3761

Autotech Accessories, Inc.
Brooklyn, NY
718-680-8901
Fax: Automatic

Bell's Security Sales
Bloomfield, NJ
800-772-2266
Fax: 201-743-6357

Blaydes Lock Co., Inc.
Washington, DC
800-424-2650
Fax: 202-832-1359

Brook's Lock & Key, Inc.
Decatur, AL
800-292-5008
Fax: 205-353-8260

Canada Lock Products -See IDN

Citizens Defensive Products
St. Joseph, MO
816-233-1512
Fax: 816-233-3092

Closed Circuit Designs
N. Miami Beach, FL
800-228-8321
Fax: 305-652-3471

Commonwealth Lock Co.
Cambridge, MA
800-442-7009
Fax: 617-661-3168

E.L. Reinhardt
Vadnais Heights, MN
800-328-1311
Fax: 612-481-0166

Empire Security Supplies
Pt. Jefferson Station, NY
516-928-1919
Fax: 516-928-4745

Fairway Supply, Inc.
Houston, TX
800-767-3247
Fax: 713-957-2122

Fried Bros. Inc.
Philadelphia, PA
800-523-2924
Fax: 215-592-1255

H. Hoffman Co. -See IDN

H.E. Mitchell Co.
Portland, OR
800-626-5625
Fax: 503-238-5715

Hans Johnsen Co.
Dallas, TX
800-678-1560
Fax: 879-1530 or 800-967-4250

Hardware Agencies Ltd.
Toronto, Ont., Canada
800-268-6741
Fax: 416-462-1922

Hardware Sales & Supply -See IDN

Hardware Specialties, Inc.
Dubois, PA
800-872-7893
Fax: 814-371-0590

IDN - Acme, Inc.
Phoenix, AZ
800-525-3131
Fax: 602-241-0249

IDN - Acme, Inc.
Denver, CO
800-445-4008
Fax: 303-292-4369

IDN - Acme, Inc.
New Orleans, LA
800-788-2263
Fax: 504-837-7321

IDN - Acme, Inc.
Oklahoma City, OK
405-942-8750
Fax: 405-942-0523

IDN - Acme, Inc.
Fort Worth, TX
800-859-2263
Fax: 817-284-3501

IDN - Acme, Inc.
Houston, TX
800-359-2263
Fax: 713-668-8050

IDN - Acme, Inc.
Richardson, TX
214-664-1240
Fax: 214-664-1252

IDN - Acme, Inc.
Richardson, TX
214-664-1240
Fax: 214-664-1252

IDN - Acme, Inc.
San Antonio, TX
210-545-3396
Fax: 210-545-2198

IDN - Armstrong's, Inc.
Jacksonville, FL
800-341-7857
Fax: 904-387-4568

IDN - Armstrong's, Inc.
N. Miami Beach, FL
800-827-3332
Fax: 305-652-1709

IDN - Armstrong's, Inc.
Orlando, FL
800-775-1220
Fax: 407-297-9522

IDN - Armstrong's, Inc.
Tampa, FL
800-829-3332
Fax: 813-886-5696

IDN - Armstrong's, Inc.
Atlanta, GA
800-726-3332
Fax: 404-888-0834

IDN - Armstrong's, Inc.
Norfolk, VA
800-735-3334
Fax: 804-853-1832

IDN - Canada
Calgary, Alberta, Canada
800-813-5344
Fax: 403-291-4893

IDN - Canada
Edmonton, Alberta, Canada
403-944-0014
Fax: 403-944-0929

IDN - Canada
Ottawa, Ontario, Canada
613-749-2172
Fax: 613-749-6651

IDN - Canada
Toronto, Ontario, Canada
800-268-1306
Fax: 416-248-9945

IDN - H. Hoffman, Inc.
Davenport, IA
800-391-4633
Fax: 319-391-7949

IDN - H. Hoffman, Inc.
Chicago, IL
800-323-1918
Fax: 708-456-0878

IDN - H. Hoffman, Inc.
Indianapolis, IN
800-382-9449
Fax: 317-637-2358

IDN - H. Hoffman, Inc.
Overland Park, KS
800-526-5897
Fax: 913-599-4160

IDN - H. Hoffman, Inc.
St. Louis, MO
800-392-1303
Fax: 314-426-6389

IDN - H. Hoffman, Inc.
Cincinnati, OH
800-457-3963
Fax: 513-271-8567

IDN - H. Hoffman, Inc.
Valley View, OH
800-247-8217
Fax: 216-642-3901

IDN - H. Hoffman, Inc.
Menomonee Falls, WI
800-472-9191
Fax: 414-252-4378

IDN - Hardware Sales, Inc.
Ferndale, MI
800-468-7490
Fax: 313-545-0627

IDN - Hardware Sales, Inc.
Grand Rapids, MI
800-244-2444
Fax: 616-534-1904

IDN - Hardware Sales, Inc.
Livonia, MI
800-521-0955
Fax: 313-591-7289

IDN - Hardware Sales, Inc.
Pittsburgh, PA
800-837-5625
Fax: 412-771-6350

IDN - M. Taylor, Inc.
Philadelphia, PA
800-233-3355
Fax: 215-288-2511

Intermountain Lock & Supply
Denver, CO
800-323-8046
Fax: 303-698-2094

Island Pacific Distributors, Inc.
Honolulu, HI
808-955-1126
Fax: 808-946-6480

J. Nathan Hardware Specialties Inc.
Rochester, NY
800-634-2580
Fax: 716-325-7196

Jo-Van Distributors
Scarborough, Ont., Canada
800-268-5731
Fax: 800-286-5010

Johansson Wholesale
Tampa, FL
800-854-3320
Fax: 800-808-2281

Key Sales & Supply Co.
Detroit, MI
800-445-KEYS (5397)
Fax: 313-931-7758

Kramer Boys Locksmith Supply
Trenton, NJ
800-222-2692
Fax: 609-586-0512

M. Shepse Co. Div. American Bionics
Pittsburgh, PA
800-666-6007
Fax: 412-381-5122

M. Taylor Inc. -See IDN

McDonald Dash Locksmith Supply, Inc.
Memphis, TN
800-238-7541
Fax: 901-366-0005

Monaco Lock Company, Inc.
Jersey City, NJ
800-526-6094
Fax: 800-845-LOCK

Omaha Wholesale Hdwe.
Omaha, NE
800-238-4566
Fax: 800-538-4566

Pasek Corp.
So. Boston, MA
800-628-2822
Fax: 617-269-0547 or 800-262-0547

Richardson Electronics, Ltd.
La Fox, IL
800-348-5580
Fax: 708-208-2550

S & J Products & Services
Yakima, WA
800-735-1797
Fax: 509-575-1875

Safemasters Company, Inc.
Wilmington, DE
302-478-5204

Safemasters Company, Inc.
Chicago, IL
312-627-1440

Safemasters Company, Inc.
Des Plaines, IL
708-299-3420

Safemasters Company, Inc.
Boston, MA
617-423-4846

Safemasters Company, Inc.
Baltimore, MD
410-624-3300

Safemasters Company, Inc.
Silver Spring, MD
800-633-9977
Fax: 800-233-2454

Alarms continued

Safemasters Company, Inc.
Silver Spring, MD
301-608-9000

Safemasters Company, Inc.
Barrington, NJ
609-547-4706

Safemasters Company, Inc.
Philadelphia, PA
215-561-6464

Safemasters Company, Inc.
Pittsburgh, PA
412-821-5166

Safemasters Company, Inc.
Alexandria, VA
703-354-8700

Safemasters Company, Inc.
Chesapeake, VA
804-420-0404

Safemasters Company, Inc.
Norfolk, VA
804-627-1485

Security Equipment Supply
Des Plaines, IL
800-729-1306
Fax: 708-803-2143

Security Equipment Supply
Lenexa, KS
800-779-2865
Fax: 913-599-3716

Security Equipment Supply
Madison Heights, MI
800-548-0680
Fax: 810-543-5576

Security Equipment Supply
Earth City, MO
800-325-0221
Fax: 314-298-8962

Security Equipment Supply
Memphis, TN
800-475-4850
Fax: 901-365-8356

Security House Padlock Distributors
Concord, Ont., Canada
800-567-5300 "Canada wide"
Fax: 905-660-6313

Serrubec Inc.
Montreal, Dorval, Canada
800-361-0243
Fax: 514-631-0494

Shield Supply & Services Ltd.
Winnipeg, Man., Canada
204-774-1921
Fax: 204-774-5627

Southern Lock & Supply Co.
Pinellas Park, FL
800-282-2837
Fax: 800-447-2299

Southern Lock and Supply Co.
Miami, FL
305-885-5779
Fax: 305-885-8798

Southern Lock and Supply Co.
Oakland Park, FL
305-568-9669
Fax: 305-568-3397

Southern Lock and Supply Co.
Atlanta, GA
404-455-9233
Fax: 404-455-3969

Southern Lock and Supply Co.
Charlotte, NC
704-527-6777
Fax: 704-527-0058

Tweed's Security Wholesalers
Portsmouth, VA
800-544-4482
Fax: 804-399-1636

Wadsworth White Inc.
Atlanta, GA
800-458-9449
Fax: 404-458-2253

Wholesale 4 Inc.
Portland, OR
800-547-0921
Fax: 503-235-5636

Wilco Supply
Oakland, CA
800-745-5450
Fax: 510-653-5397

Architectural Hardware

A.T. Jones & Son
Detroit, MI
800-735-4570
Fax: 313-965-1093

Accredited Lock Supply Co.
Secaucus, NJ
800-652-2835
Fax: 201-865-5031

Ace Lock & Security Supply
Union, NJ
800-223-5625
Fax: 908-688-2442

Acme Security Systems
San Leandro, CA
800-348-2263
Fax: 800-435-8233

Acme Wholesale Dist. -See IDN

Adams Lock & Safe Co., Inc.
Concord, NH
800-635-2228
Fax: 603-226-4983

Agences W. Pelletier (1980) Inc.
Montreal, Quebec, Canada
800-363-6700
Fax: 514-276-9413

Akron Hdw. Consultants
Akron, OH
800-321-9602
Fax: 800-328-6070

American Lock & Key Co.
Richmond, VA
800-995-6247
Fax: 804-282-1007

American Lock & Supply
Boston, MA
800-291-2797
Fax: 800-291-2798

American Lock & Supply, Inc.
Phoenix, AZ
800-826-6968
Fax: 602-254-0272, 800-325-3728

American Lock & Supply, Inc.
Anaheim, CA
800-854-8775
Fax: 714-579-7554

American Lock & Supply, Inc.
Fremont, CA
800-227-1142
Fax: 510-651-2350, 800-662-4399

American Lock & Supply, Inc.
San Diego, CA
800-231-8435
Fax: 800-788-0916

American Lock & Supply, Inc.
Denver, CO
800-346-5549
Fax: 303-733-0202, 800-241-0202

American Lock & Supply, Inc.
Atlanta, GA
800-952-4452
Fax: 404-458-0899, 800-358-4561

American Lock & Supply, Inc.
Elmhurst, IL
800-621-0177
Fax: 708-832-9084, 800-238-5397

Continued on page 36

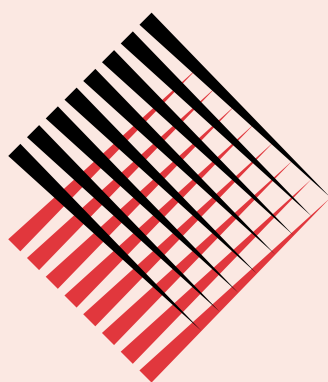

STRATTEC™

***The world's largest producer of
automotive locks and keys.***

[Click here for more information](#)

**Architectural Hardware
Continued from page 34**

American Lock & Supply, Inc.
Kansas City, KS
800-888-5625
Fax: 913-432-1342, 800-395-7945

American Lock & Supply, Inc.
Elkridge, MD
800-358-6398
Fax: 410-379-5990, 800-358-6399

American Lock & Supply, Inc.
Hauppauge, NY
800-628-5625
Fax: 516-231-2019, 800-424-7185

American Lock & Supply, Inc.
Dallas, TX
800-292-0115
Fax: 214-358-6037, 800-527-3028

American Lock & Supply, Inc.
Houston, TX
800-435-8105
Fax: 713-681-0850, 800-435-8232

American Lock & Supply, Inc.
Seattle, WA
800-356-5661
Fax: 206-431-8527, 800-392-1132

Amos Lock & Key Supply Co.
Fort Worth, TX
800-772-7432
Fax: 317-335-5399

Anderson Lock Co.
Des Plaines, IL
708-296-1157
Fax: 708-296-9259

Apex Security Hardware Corp.
Brooklyn, NY
800-232-1117
Fax: 718-438-3327, 800-951-7000

Architectural Products By Outwater,
L.L.C.
Woodridge, NJ
800-835-4400
Fax: 800-835-4403

Armstrong's Lock & Supply Inc. -See
IDN

ASLA Distributing
East Rockaway, NJ
516-766-2863
Fax: 516-766-2863

Barry Supply Co., Div. of Barry Ind.
Inc.
New York, NY
212-242-5200
Fax: 212-675-7094

Bell's Security Sales
Bloomfield, NJ
800-772-2266
Fax: 201-743-6357

Blaydes Lock Co., Inc.
Washington, DC
800-424-2650
Fax: 202-832-1359

Boston Lock & Safe Co., Inc.
Brighton, MA
800-252-5757
Fax: 617-787-3425

Boyle & Chase, Inc.
Accord, MA
800-325-2530
Fax: 617-335-5342

Brook's Lock & Key, Inc.
Decatur, AL
800-292-5008
Fax: 205-353-8260

Brooks Supply, Inc.
Oklahoma City, OK
800-347-4477
Fax: 405-672-7575

C.H. Edwards, Inc.
Greenville, NC
919-756-8500
Fax: 919-756-3884

Canada Lock Products -See IDN

Capitol Lock Co., Inc.
College Park, MD
301-513-9500
Fax: 301-513-9505

Clark Security Products
Phoenix, AZ
800-775-5625
Fax: 602-275-9235

Clark Security Products
Bell, CA
800-889-5625
Fax: 213-262-0741

Clark Security Products
San Diego, CA
800-854-2088
Fax: 619-565-4605

Clark Security Products
San Diego, CA
800-854-2088
Fax: 619-565-4605

Clark Security Products
W. Sacramento, CA
800-245-3003
Fax: 916-372-7221

Clark Security Products
Denver, CO
800-282-5625
Fax: 800-699-3329

Clark Security Products
Wood Dale, IL
800-755-5625
Fax: 708-350-8535

Clark Security Products
Auburn, MA
800-746-5625
Fax: 800-596-5625

Clark Security Products
Lanham, MD
800-578-5625
Fax: 800-378-5625

Clark Security Products
Salt Lake City, UT
800-453-6430
Fax: 801-487-3254

Clark Security Products
Seattle, WA
800-942-5275
Fax: 800-546-5625

Colonial Lock Supply Co., Inc.
Newington, VA
800-732-9117
Fax: 703-550-8857

Commonwealth Lock Co.
Cambridge, MA
800-442-7009
Fax: 617-661-3168

Craftmaster Hardware Co., Inc.
Hackensack, NJ
800-221-3212
Fax: 201-646-0181

Cypress Security Products Ltd.
Calgary, AB, Canada
800-561-1967
Fax: 403-250-1969

Dave Sanders & Co. Inc.
New York, NY
212-334-9898
Fax: 212-966-4185

Door Closer Service Co., Inc.
Washington, DC
800-566-0606
Fax: 800-908-3667, 202-529-7826

medeco[®]
HIGH SECURITY LOCKS

**Integrity. Ingenuity....
security solutions.**

[Click here for more information](#)

Door Hardware Distributors, Inc.
Milwaukee, WI
800-829-8905
Fax: 414-291-5685

Doyle Lock Supply, Inc.
Minneapolis, MN
800-333-6953
Fax: 612-521-0166

Dugmore and Duncan of California
Riverside, CA
800-325-1595
Fax: 909-360-0572

Dugmore and Duncan of Florida
Lakeland, FL
800-232-1595
Fax: 813-666-5226

Dugmore and Duncan, Inc.
Hingham, MA
800-225-1595
Fax: 617-740-4043

E.L. Reinhardt
Vadnais Heights, MN
800-328-1311
Fax: 612-481-0166

Edw. Saucedo & Son Co., Inc.
El Paso, TX
800-248-3726
Fax: 915-566-8608

Elly Express
Wheeling, IL
800-432-1311
Fax: 708-480-1383

Empire Security Supplies
Pt. Jefferson Station, NY
516-928-1919
Fax: 516-928-4745

Enixus Trade, Ltd.
St. Catharines, Ont., Canada
905-682-3086
Fax: 905-682-3086

Ewert Wholesale Hardware Inc.
Alsip, IL
800-451-0200
Fax: 708-597-0881

Express Hardware
Barrington, IL
800-323-7447
Fax: 708-381-7199

Fairway Supply, Inc.
Houston, TX
800-767-3247
Fax: 713-957-2122

Fastrack Hardware, Inc.
Brookfield, WI
800-458-8707
Fax: 800-667-8701

Fortress Safe & Lock
Cincinnati, OH
800-562-0295
Fax: 513-772-5276

Fradon Lock Co., Inc.
Syracuse, NY
800-447-0591
Fax: 315-472-0958

Fried Bros. Inc.
Philadelphia, PA
800-523-2924
Fax: 215-592-1255

Gamalski Building Specialties
Auburn Hills, MI
810-852-7050
Fax: 810-852-8390

Grace's Wholesale & Supply Div.
Hastings, NE
402-462-2737

Great Lakes Lock Distributors
Erie, PA
800-543-8837
Fax: 814-456-1542

H & H Lock & Security Wholesalers
Gaithersburg, MD
800-772-9811
Fax: 301-948-5265

H. Hoffman Co. -See IDN

H.E. Mitchell Co.
Portland, OR
800-626-5625
Fax: 503-238-5715

H.S. & S. Wholesale Dist. of Lock
Hdwe.
Detroit, MI
800-342-2202
Fax: 313-342-7580
Hans Johnsen Co.
Dallas, TX
800-678-1560
Fax: 879-1530 or 800-967-4250

Hardware Agencies Ltd.
Toronto, Ont., Canada
800-268-6741
Fax: 416-462-1922

Hardware Sales & Supply -See IDN

Hardware Specialties, Inc.
Dubois, PA
800-872-7893
Fax: 814-371-0590

Hardware Suppliers of America, Inc.
Fresno, CA
800-334-5625

Hardware Suppliers of America, Inc.
Oldsmar, FL
800-282-8499

Hardware Suppliers of America, Inc.
Cumming, GA
800-358-6016

Hardware Suppliers of America, Inc.
Winterville, NC
800-334-5625
Fax: 800-334-5635

Hardware Suppliers of America, Inc.
Manfield, OH
800-334-5625

Hardware Suppliers of America, Inc.
Irving, TX
800-334-5625

Hardware Suppliers of America, Inc.
(HSI)
Winterville, NC
800-334-5625
Fax: 800-334-5635

Herbert Flake Co.
Houston, TX
800-231-4105
Fax: 713-926-3399

HMC, Int'l Div., Inc.
Littleton, CO
800-848-4912 ext. 4452
Fax: 303-794-3703

Howard Sales Co.
El Paso, TX
800-456-4625
Fax: 915-833-7770

IDN - Acme, Inc.
Phoenix, AZ
800-525-3131
Fax: 602-241-0249

IDN - Acme, Inc.
Denver, CO
800-445-4008
Fax: 303-292-4369

IDN - Acme, Inc.
New Orleans, LA
800-788-2263
Fax: 504-837-7321

IDN - Acme, Inc.
Oklahoma City, OK
405-942-8750
Fax: 405-942-0523

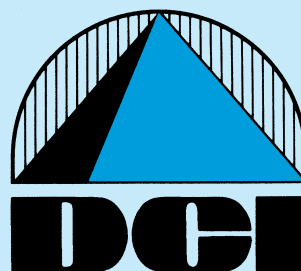

Don't panic!

We have Security
Exit Devices.

[Click here for more information](#)

DISTRIBUTORS by PRODUCT

Architectural Hardware continued

IDN - Acme, Inc.
Fort Worth, TX
800-859-2263
Fax: 817-284-3501

IDN - Acme, Inc.
Houston, TX
800-359-2263
Fax: 713-668-8050

IDN - Acme, Inc.
Richardson, TX
214-664-1240
214-664-1252

IDN - Acme, Inc.
San Antonio, TX
210-545-3396
Fax: 210-545-2198

IDN - Armstrong's, Inc.
Jacksonville, FL
800-341-7857
Fax: 904-387-4568

IDN - Armstrong's, Inc.
N. Miami Beach, FL
800-827-3332
Fax: 305-652-1709

IDN - Armstrong's, Inc.
Orlando, FL
800-775-1220
Fax: 407-297-9522

IDN - Armstrong's, Inc.
Tampa, FL
800-829-3332
Fax: 813-886-5696

IDN - Armstrong's, Inc.
Atlanta, GA
800-726-3332
Fax: 404-888-0834

IDN - Armstrong's, Inc.
Norfolk, VA
800-735-3334
Fax: 804-853-1832

IDN - Canada
Calgary, Alberta, Canada
800-813-5344
Fax: 403-291-4893

IDN - Canada
Edmonton, Alberta, Canada
403-944-0014
Fax: 403-944-0929

IDN - Canada
Ottawa, Ontario, Canada
613-749-2172
Fax: 613-749-6651

IDN - Canada
Toronto, Ontario, Canada
800-268-1306
Fax: 416-248-9945

IDN - H. Hoffman, Inc.
Davenport, IA
800-391-4633
Fax: 319-391-7949

IDN - H. Hoffman, Inc.
Chicago, IL
800-323-1918
Fax: 708-456-0878

IDN - H. Hoffman, Inc.
Indianapolis, IN
800-382-9449
Fax: 317-637-2358

IDN - H. Hoffman, Inc.
Overland Park, KS
800-526-5897
Fax: 913-599-4160

IDN - H. Hoffman, Inc.
St. Louis, MO
800-392-1303
Fax: 314-426-6389

IDN - H. Hoffman, Inc.
Cincinnati, OH
800-457-3963
Fax: 513-271-8567

IDN - H. Hoffman, Inc.
Valley View, OH
800-247-8217
Fax: 216-642-3901

IDN - H. Hoffman, Inc.
Menomonee Falls, WI
800-472-9191
Fax: 414-252-4378

IDN - Hardware Sales, Inc.
Ferndale, MI
800-468-7490
Fax: 313-545-0627

IDN - Hardware Sales, Inc.
Grand Rapids, MI
800-244-2444
Fax: 616-534-1904

IDN - Hardware Sales, Inc.
Livonia, MI
800-521-0955
Fax: 313-591-7289

IDN - Hardware Sales, Inc.
Pittsburgh, PA
800-837-5625
Fax: 412-771-6350

IDN - M. Taylor, Inc.
Philadelphia, PA
800-233-3355
Fax: 215-288-2511

Independent Hardware Inc.
Philadelphia, PA
800-346-9464
Fax: 215-922-6552

Intermountain Lock & Supply
Denver, CO
800-323-8046
Fax: 303-698-2094

International Door Closers, Inc.
Nashville, TN
800-225-6737
Fax: 615-885-0903

Island Pacific Distributors, Inc.
Honolulu, HI
808-955-1126
Fax: 808-946-6480

J. Nathan Hardware Specialties Inc.
Rochester, NY
800-634-2580
Fax: 716-325-7196

Jack Stearman Ltd.
Vancouver, B.C., Canada
604-872-8415
Fax: 604-875-9174

JLM Wholesale, Inc.
Oxford, MI
800-522-2940
Fax: 800-782-1160

Jo-Van Distributors
Scarborough, Ont., Canada
800-268-5731
Fax: 800-286-5010

Johansson Wholesale
Tampa, FL
800-854-3320
Fax: 800-808-2281

Kenco Supply Co.
Omaha, NE
800-228-2266
Fax: 800-228-4175

Key Hardware Company
Los Angeles, CA
213-255-9873
Fax: 213-255-8457

Key Mart Inc.
Stuart, FL
800-228-7755
Fax: 407-220-7920

Key Sales & Supply Co.
Detroit, MI
800-445-KEYS (5397)
Fax: 313-931-7758

Keys Wholesale Distributors
Drexel Hill, PA
800-292-5397
Fax: 610-626-4189

Kolson, Inc.
Great Neck, NY
800-783-1335
Fax: 516-487-1231

Kramer Boys Locksmith Supply
Trenton, NJ
800-222-2692
Fax: 609-586-0512

Lock Wise Security Products
Miami, FL
800-447-6616
Fax: 305-623-9564

Locks Co.
N. Miami, FL
800-288-0801
Fax: 305-949-3619

M. Shepse Co. Div. American Bionics
Pittsburgh, PA
800-666-6007
Fax: 412-381-5122

M. Taylor Inc. -See IDN

Major Lock Supply
Fullerton, CA
714-447-8363
Fax: 714-447-8393

Mayflower Sales Co., Inc.
Brooklyn, NY
800-224-2052
Fax: 718-789-8346

Maziuk & Co., Inc.
Syracuse, NY
800-777-5945
Fax: 315-472-3111

McDonald Dash Locksmith Supply, Inc.
Memphis, TN
800-238-7541
Fax: 901-366-0005

McManus Locksmith Supply, Inc.
Charlotte, NC
NC 800-432-6342, SC 800-438-6567
Fax: 704-332-8664

Micro Affiliates
Rockville, MD
800-430-1099
Fax: 301-881-0340

Mid-South Locksmith Supply
Memphis, TN
800-238-6166
Fax: 901-795-3475

Midwest Wholesale Distributors
Kansas City, MO
800-821-8527
Fax: 800-621-6581

Midwest Wholesale Hardware
Orlando, FL
800-659-8527
Fax: 800-659-6581

Monaco Lock Company, Inc.
Jersey City, NJ
800-526-6094
Fax: 800-845-LOCK

New England Door Closer, Inc.
West Springfield, MA
800-628-1071
Fax: 413-731-8368

Northwest Lock & Supply Co.
Albany, OR
800-359-9425
Fax: 503-928-9338

Omaha Wholesale Hdwe.
Omaha, NE
800-238-4566
Fax: 800-538-4566

Orchard Lock Distributors, Inc.
Hamden, CT
800-233-2146
Fax: 203-624-4083

Pasek Corp.
So. Boston, MA
800-628-2822
Fax: 617-269-0547 or 800-262-0547

R.A. Graham Co., Inc.
Worcester, MA
800-333-3933
Fax: 508-755-6584

Renaud Sales Canada Corp.
Richmond Hill, Ont., Canada
905-707-0090
Fax: 800-791-8130

Richmond Industrial Supplies
Staten Island, NY
800-462-9997
Fax: 718-981-5665

Rininger Lock & Supply
Lemon Grove, CA
619-463-0170
Fax: 619-697-2590

Robert Skeels & Company
Compton, CA
800-734-4539
Fax: 310-639-7569

Safemasters Company, Inc.
Wilmington, DE
302-478-5204

Safemasters Company, Inc.
Chicago, IL
312-627-1440

Safemasters Company, Inc.
Des Plaines, IL
708-299-3420

Safemasters Company, Inc.
Boston, MA
617-423-4846

Safemasters Company, Inc.
Baltimore, MD
410-624-3300

Safemasters Company, Inc.
Silver Spring, MD
301-608-9000

Safemasters Company, Inc.
Silver Spring, MD
800-633-9977
Fax: 800-233-2454

Safemasters Company, Inc.
Barrington, NJ
609-547-4706

Safemasters Company, Inc.
Philadelphia, PA
215-561-6464

Safemasters Company, Inc.
Pittsburgh, PA
412-821-5166

Safemasters Company, Inc.
Alexandria, VA
703-354-8700

Safemasters Company, Inc.
Chesapeake, VA
804-420-0404

Safemasters Company, Inc.
Norfolk, VA
804-627-1485

Secure Industries, Inc.
Hicksville, NY
800-999-2534
Fax: 516-433-8804

Security House Padlock Distributors
Concord, Ont., Canada
800-567-5300 "Canada wide"
Fax: 905-660-6313

Continued on page 40

**Architectural Hardware
Continued from page 38**

Security Lock Distributors
Needham Heights, MA
800-847-5625
Fax: 800-878-6400

Security Plus
Phoenix, AZ
800-426-0200
Fax: 602-234-3882

Sentinel Wholesale Hdwe. Sen. Div.
Ind.
E. Farmingdale, NY
800-526-9000
Fax: 516-753-6004

Septon Inc.
Maden-On-The-Hudson, NY
800-537-8752
Fax: 914-246-3416

Serrubec Inc.
Montreal, Dorval, Canada
800-361-0243
Fax: 514-631-0494

Shield Supply & Services Ltd.
Winnipeg, Man., Canada
204-774-1921
Fax: 204-774-5627

Silver Sales
Plano, TX
800-258-5625
Fax: 214-618-1897

Southern Lock & Supply Co.
Pinellas Park, FL
800-282-2837
Fax: 800-447-2299

Southern Lock and Supply Co.
Miami, FL
305-885-5779
Fax: 305-885-8798

Southern Lock and Supply Co.
Oakland Park, FL
305-568-9669
Fax: 305-568-3397

Southern Lock and Supply Co.
Atlanta, GA
404-455-9233
Fax: 404-455-3969

Southern Lock and Supply Co.
Charlotte, NC
704-527-6777
Fax: 704-527-0058

Standard Wholesale Hardware Inc.
New York, NY
800-543-5625
Fax: 212-420-9892

Stears Locksmith Supply Co.
Sag Harbor, NY
516-725-3273 or 516-725-8151
Fax: 516-725-7483

Stone & Berg Wholesale Locksmith
Supply
Worcester, MA
800-225-7405
Fax: 800-535-5625

Taylor Security & Lock Co., Inc.
Gailthersburg, MD
800-676-7670
Fax: 301-948-1029

Top Notch Distributors
Honesdale, PA
800-233-4210
Fax: 800-854-4146

Trans-Atlantic Company
Philadelphia, PA
800-523-9956
Fax: 215-629-1282

Transwest Hardware Sales
Vancouver, B.C., Canada
800-567-1177
Fax: 604-253-5344

Tweed Security Hardware
Wholesalers
Portsmouth, VA
800-544-4482
Fax: 804-399-1636

Wadsworth White Inc.
Atlanta, GA
800-458-9449
Fax: 404-458-2253

Waldron's Security
Denver, CO
800-255-0701
Fax: 303-934-3452

Wholesale 4 Inc.
Portland, OR
800-547-0921
Fax: 503-235-5636

Wilco Supply
Oakland, CA
800-745-5450
Fax: 510-653-5397

Zipf Lock Co.
Columbus, OH
800-848-1577
Fax: 800-228-6320

Training Manuals & Materials

Access Safe & Supply Ltd.
Burlington, Ont., Canada
800-268-9033
Fax: 905-319-0366

Accredited Lock Supply Co.
Secaucus, NJ
800-652-2835
Fax: 201-865-5031

Ace Lock & Security Supply
Union, NJ
800-223-5625
Fax: 908-688-2442

Acme Wholesale Dist. -See IDN

Agences W. Pelletier (1980) Inc.
Montreal, Quebec, Canada
800-363-6700
Fax: 514-276-9413

Allied Locksmith Supply
Youngstown, OH
800-544-2102
Fax: 216-726-0865

Anderson Lock Co.
Des Plaines, IL
708-296-1157
Fax: 708-296-9259

Aristo Sales Co., Inc.
Long Island City, NY
800-221-1322
Fax: 718-937-5794

Armstrong's Lock & Supply Inc. -See IDN

Associated Lock & Supply
Port Coquillam, BC, Canada
800-373-5754
Fax: 604-942-3761

Blaydes Lock Co., Inc.
Washington, DC
800-424-2650
Fax: 202-832-1359

Brooks Supply, Inc.
Oklahoma City, OK
800-347-4477
Fax: 405-672-7575

Canada Lock Products -See IDN

Clark Security Products
Phoenix, AZ
800-775-5625
Fax: 602-275-9235

Clark Security Products
Bell, CA
800-889-5625
Fax: 213-262-0741

Clark Security Products
San Diego, CA
800-854-2088
Fax: 619-565-4605

Clark Security Products
San Diego, CA
800-854-2088
Fax: 619-565-4605

Clark Security Products
W. Sacramento, CA
800-245-3003
Fax: 916-372-7221

Clark Security Products
Denver, CO
800-282-5625
Fax: 800-699-3329

Clark Security Products
Wood Dale, IL
800-755-5625
Fax: 708-350-8535

Clark Security Products
Auburn, MA
800-746-5625
Fax: 800-596-5625

Clark Security Products
Lanham, MD
800-578-5625
Fax: 800-378-5625

Clark Security Products
Salt Lake City, UT
800-453-6430
Fax: 801-487-3254

Clark Security Products
Seattle, WA
800-942-5275
Fax: 800-546-5625

Craftmaster Hardware Co., Inc.
Hackensack, NJ
800-221-3212
Fax: 201-646-0181

DiMark International
Santa Maria, CA
800-235-2435
Fax: 805-928-8034

Doyle Lock Supply, Inc.
Minneapolis, MN
800-333-6953
Fax: 612-521-0166

E.L. Reinhardt
Vadnais Heights, MN
800-328-1311
Fax: 612-481-0166

Ewert Wholesale Hardware Inc.
Alsip, IL
800-451-0200
Fax: 708-597-0881

Fairway Supply, Inc.
Houston, TX
800-767-3247
Fax: 713-957-2122

Foley Belsaw Co., Locksmith Division
Kansas City, MO
800-821-3452
Fax: 816-483-5010

Fradon Lock Co., Inc.
Syracuse, NY
800-447-0591
Fax: 315-472-0958

Fried Bros. Inc.
Philadelphia, PA
800-523-2924
Fax: 215-592-1255

Gil-Ray Tools, Inc.
Bay City, MI
517-892-6870
Fax: 517-892-6870

Grace's Wholesale & Supply Div.
Hastings, NE
402-462-2737

Great Lakes Lock Distributors
Erie, PA
800-543-8837
Fax: 814-456-1542

H. Hoffman Co. -See IDN

H.E. Mitchell Co.
Portland, OR
800-626-5625
Fax: 503-238-5715

Hans Johnsen Co.
Dallas, TX
800-678-1560
Fax: 879-1530 or 800-967-4250

Hardware Agencies Ltd.
Toronto, Ont., Canada
800-268-6741
Fax: 416-462-1922



[Click here for more information](#)

**SRI and Tech Train
Productions are the
automotive specialists
- your best source for
automotive tools,
manuals, and videos.**

Continued on page 42

**Training Manuals & Materials
Continued from page 40**

Hardware Sales & Supply - See IDN

Herbert Flake Co.
Houston, TX
800-231-4105
Fax: 713-926-3399

IDN - Acme, Inc.
Phoenix, AZ
800-525-3131
Fax: 602-241-0249

IDN - Acme, Inc.
Denver, CO
800-445-4008
Fax: 303-292-4369

IDN - Acme, Inc.
New Orleans, LA
800-788-2263
Fax: 504-837-7321

IDN - Acme, Inc.
Oklahoma City, OK
405-942-8750
Fax: 405-942-0523

IDN - Acme, Inc.
Fort Worth, TX
800-859-2263
Fax: 817-284-3501

IDN - Acme, Inc.
Houston, TX
800-359-2263
Fax: 713-668-8050

IDN - Acme, Inc.
Richardson, TX
214-664-1240
Fax: 214-664-1252

IDN - Acme, Inc.
San Antonio, TX
210-545-3396
Fax: 210-545-2198

IDN - Armstrong's, Inc.
Jacksonville, FL
800-341-7857
Fax: 904-387-4568

IDN - Armstrong's, Inc.
N. Miami Beach, FL
800-827-3332
Fax: 305-652-1709

IDN - Armstrong's, Inc.
Orlando, FL
800-775-1220
Fax: 407-297-9522

IDN - Armstrong's, Inc.
Tampa, FL
800-726-3332
Fax: 813-886-5696

IDN - Armstrong's, Inc.
Atlanta, GA
800-726-3332
Fax: 404-888-0834

IDN - Armstrong's, Inc.
Norfolk, VA
800-735-3334
Fax: 804-853-1832

IDN - Canada
Calgary, Alberta, Canada
800-813-5344
Fax: 403-291-4893

IDN - Canada
Edmonton, Alberta, Canada
403-944-0014
Fax: 403-944-0929

IDN - Canada
Ottawa, Ontario, Canada
613-749-2172
Fax: 613-749-6651

IDN - Canada
Toronto, Ontario, Canada
800-268-1306

Fax: 416-248-9945

IDN - H. Hoffman, Inc.
Davenport, IA
800-391-4633
Fax: 319-391-7949

IDN - H. Hoffman, Inc.
Chicago, IL
800-323-1918
Fax: 708-456-0878

IDN - H. Hoffman, Inc.
Indianapolis, IN
800-382-9449
Fax: 317-637-2358

IDN - H. Hoffman, Inc.
Overland Park, KS
800-526-5897
Fax: 913-599-4160

IDN - H. Hoffman, Inc.
St. Louis, MO
800-392-1303
Fax: 314-426-6389

IDN - H. Hoffman, Inc.
Cincinnati, OH
800-457-3963
Fax: 513-271-8567

IDN - H. Hoffman, Inc.
Valley View, OH
800-247-8217
Fax: 216-642-3901

IDN - H. Hoffman, Inc.
Menomonee Falls, WI
800-472-9191
Fax: 414-252-4378

IDN - Hardware Sales, Inc.
Ferndale, MI
800-468-7490
Fax: 313-545-0627

IDN - Hardware Sales, Inc.

Grand Rapids, MI
800-244-2444
Fax: 616-534-1904

IDN - Hardware Sales, Inc.
Livonia, MI
800-521-0955
Fax: 313-591-7289

IDN - Hardware Sales, Inc.
Pittsburgh, PA
800-837-5625
Fax: 412-771-6350

IDN - M. Taylor, Inc.
Philadelphia, PA
800-233-3355
Fax: 215-288-2511

Intermountain Lock & Supply
Denver, CO
800-323-8046
Fax: 303-698-2094

J & J Distributors
San Antonio, TX
210-734-6165
Fax: 210-735-2248

J. Nathan Hardware Specialties Inc.
Rochester, NY
800-634-2580
Fax: 716-325-7196

Jack Stearman Ltd.
Vancouver, B.C., Canada
604-872-8415
Fax: 604-875-9174

Jo-Van Distributors
Scarborough, Ont., Canada
800-268-5731
Fax: 800-286-5010

Kenco Supply Co.
Omaha, NE
800-228-2266
Fax: 800-228-4175

DISTRIBUTORS by PRODUCT

NATIONAL AUTO LOCK SERVICE, INC.

National Auto Lock Service, Inc. offers a wide range of equipment and services for the Automotive Locksmith. From tools and hard to find key blanks to transponder programming, we can take the mystery out of car service. We accept credit card orders, and can ship COD. Contact us for the latest in automotive technology.

Key Hardware Company
Los Angeles, CA
213-255-9873
Fax: 213-255-8457

Key Sales & Supply Co.
Detroit, MI
800-445-KEYS (5397)
Fax: 313-931-7758

Keys Wholesale Distributors
Drexel Hill, PA
800-292-5397
Fax: 610-626-4189

Kramer Boys Locksmith Supply
Trenton, NJ
800-222-2692
Fax: 609-586-0512

LDM Enterprises, Inc.
Westlake Village, CA
800-451-5950
Fax: 818-706-8560

Lock Wise Security Products
Miami, FL
800-447-6616
Fax: 305-623-9564

Lockmasters Inc.
Nicolasville, KY
800-654-0637
Fax: 606-885-7093

Locks Co.
N. Miami, FL
800-288-0801
Fax: 305-949-3619

M. Taylor Inc. -See IDN

Major Lock Supply
Fullerton, CA
714-447-8363
Fax: 714-447-8393

Mark Bates Associates
Nicholasville, KY
800-555-4471
Fax: 606-858-4292

Mayflower Sales Co., Inc.
Brooklyn, NY
800-224-2052
Fax: 718-789-8346

Maziuk & Co., Inc.
Syracuse, NY
800-777-5945
Fax: 315-472-3111

McDonald Dash Locksmith Supply, Inc.
Memphis, TN
800-238-7541
Fax: 901-366-0005

McManus Locksmith Supply, Inc.
Charlotte, NC
NC 800-432-6342, SC 800-438-6567
Fax: 704-332-8664

Mid-South Locksmith Supply
Memphis, TN
800-238-6166
Fax: 901-795-3475

Northwest Lock & Supply Co.
Albany, OR
800-359-9425
Fax: 503-928-9338

Orchard Lock Distributors, Inc.
Hamden, CT
800-233-2146
Fax: 203-624-4083

Rininger Lock & Supply
Lemon Grove, CA
619-463-0170
Fax: 619-697-2590

Robert Skeels & Company
Compton, CA
800-734-4539
Fax: 310-639-7569

Safemasters Company, Inc.
Wilmington, DE
302-478-5204

Safemasters Company, Inc.
Chicago, IL
312-627-1440

Safemasters Company, Inc.
Des Plaines, IL
708-299-3420

Safemasters Company, Inc.
Boston, MA
617-423-4846

Safemasters Company, Inc.
Baltimore, MD
410-624-3300

Safemasters Company, Inc.
Silver Spring, MD
800-633-9977
Fax: 800-233-2454

Safemasters Company, Inc.
Silver Spring, MD
301-608-9000

Safemasters Company, Inc.
Barrington, NJ
609-547-4706

Safemasters Company, Inc.
Philadelphia, PA
215-561-6464

Safemasters Company, Inc.
Pittsburgh, PA
412-821-5166

Safemasters Company, Inc.
Alexandria, VA
703-354-8700

Safemasters Company, Inc.
Chesapeake, VA
804-420-0404

Safemasters Company, Inc.
Norfolk, VA
804-627-1485

Security Plus
Phoenix, AZ
800-426-0200
Fax: 602-234-3882

Septon Inc.
Maden-On-The-Hudson, NY
800-537-8752
Fax: 602-234-3416

Serrubec Inc.
Montreal, Dorval, Canada
800-361-0243
Fax: 514-631-0494

Shield Supply & Services Ltd.
Winnipeg, Man., Canada
204-774-1921
Fax: 204-774-5627

Slide Lock Tool Co
Louisville, TN
800-336-8812
Fax: 615-577-5936

Southern Lock & Supply Co.
Pinellas Park, FL
800-282-2837
Fax: 800-447-2299

Southern Lock and Supply Co.
Miami, FL
305-885-5779
Fax: 305-885-8798

Southern Lock and Supply Co.
Oakland Park, FL
305-568-9669
Fax: 305-568-3397

Southern Lock and Supply Co.
Atlanta, GA
404-455-9233
Fax: 404-455-3969



***To be a World Leader You Need Quality Products,
Innovative Technology and Strong Partners.***

[Click here for more information](#)



*Choose S&G
Comptronic
electronic safe
locks for...
security...
technology...
tradition.*

[Click here for more information](#)

**Training Manuals & Materials
continued**

Southern Lock and Supply Co.
Charlotte, NC
704-527-6777
Fax: 704-527-0058

Space Age Locksmith Supplies, Inc.
Deland, FL
800-247-7942
Fax: 904-734-0559

Standard Wholesale Hardware Inc.
New York, NY
800-543-5625
Fax: 212-420-9892

Stone & Berg Wholesale Locksmith
Supply
Worcester, MA
800-225-7405
Fax: 800-535-5625

Timemasters
Topeka, KS
913-232-8705
Fax: 800-798-TIME

Tweed's Security Hardware
Wholesalers
Portsmouth, VA
800-544-4482
Fax: 804-399-1636

Wholesale 4 Inc.
Portland, OR
800-547-0921
Fax: 503-235-5636

The National Locksmith
Streamwood
708-837-2044
Fax: 708-837-1210

Wilco Supply
Oakland, CA
800-745-5450
Fax: 510-653-5397

Zipf Lock Co.
Columbus, OH
800-848-1577
Fax: 800-228-6320

Locksmith Software

A. T. Jones & Son
Detroit, MI
800-735-4570
Fax: 313-965-1093

Access Safe & Supply Ltd.
Burlington, Ont., Canada
800-268-9033
Fax: 905-319-0366

Accredited Lock Supply Co.
Secaucus, NJ
800-652-2835
Fax: 201-865-5031

Ace Lock & Security Supply
Union, NJ
800-223-5625
Fax: 908-688-2442

Acme Wholesale Dist. -See IDN

Agences W. Pelletier (1980) Inc.
Montreal, Quebec, Canada
800-363-6700
Fax: 514-276-9413

Allied Locksmith Supply
Youngstown, OH
800-544-2102
Fax: 216-726-0865

Armstrong's Lock & Supply Inc. -See
IDN

Associated Lock & Supply
Port Coquitlam, BC, Canada
800-373-5754
Fax: 604-942-3761

Boyle & Chase, Inc.
Accord, MA
800-325-2530
Fax: 617-335-5342

Brooks Supply, Inc.
Oklahoma City, OK
800-347-4477
Fax: 405-672-7575

Canada Lock Products -See IDN

Clark Security Products
Phoenix, AZ
800-775-5625
Fax: 602-275-9235

Clark Security Products
Bell, CA
800-889-5625
Fax: 213-262-0741

Clark Security Products
San Diego, CA
800-854-2088
Fax: 619-565-4605

Clark Security Products
San Diego, CA
800-854-2088
Fax: 619-565-4605

Clark Security Products
W. Sacramento, CA
800-245-3003
Fax: 916-372-7221

Clark Security Products
Denver, CO
800-282-5625
Fax: 800-699-3329

Clark Security Products
Wood Dale, IL
800-755-5625
Fax: 708-350-8535

Clark Security Products
Auburn, MA
800-746-5625
Fax: 800-596-5625

Clark Security Products
Lanham, MD
800-578-5625
Fax: 800-378-5625

Clark Security Products
Salt Lake City, UT
800-453-6430
Fax: 801-487-3254

Clark Security Products
Seattle, WA
800-942-5275
Fax: 800-546-5625

Commonwealth Lock Co.
Cambridge, MA
800-442-7009
Fax: 617-661-3168

Craftmaster Hardware Co., Inc.
Hackensack, NJ
800-221-3212
Fax: 201-646-0181

DiMark International
Santa Maria, CA
800-235-2435
Fax: 805-928-8034

Doyle Lock Supply, Inc.
Minneapolis, MN
800-333-6953
Fax: 612-521-0166

E.L. Reinhardt
Vadnais Heights, MN
800-328-1311
Fax: 612-481-0166

Ewert Wholesale Hardware Inc.
Alsip, IL
800-451-0200
Fax: 708-597-0881

Fairway Supply, Inc.
Houston, TX
800-767-3247
Fax: 713-957-2122

Foley Belsaw Co., Locksmith Division
Kansas City, MO
800-821-3452
Fax: 816-483-5010

Fried Bros. Inc.
Philadelphia, PA
800-523-2924
Fax: 215-592-1255

Grace's Wholesale & Supply Div.
Hastings, NE
402-462-2737

H. Hoffman Co. -See IDN

H.E. Mitchell Co.
Portland, OR
800-626-5625
Fax: 503-238-5715

H.S. & S. Wholesale Dist. of Lock
Hdwe.
Detroit, MI
800-342-2202
Fax: 313-342-7580

Hans Johnsen Co.
Dallas, TX
800-678-1560
Fax: 879-1530 or 800-967-4250

Hardware Agencies Ltd.
Toronto, Ont., Canada
800-268-6741
Fax: 416-462-1922

Hardware Sales & Supply -See IDN

Herbert Flake Co.
Houston, TX
800-231-4105
Fax: 713-926-3399

IDN - Acme, Inc.
Phoenix, AZ
800-525-3131
Fax: 602-241-0249

IDN - Acme, Inc.
Denver, CO
800-445-4008
Fax: 303-292-4369

IDN - Acme, Inc.
New Orleans, LA
800-788-2263
Fax: 504-837-7321

IDN - Acme, Inc.
Oklahoma City, OK
405-942-8750
Fax: 405-942-0523

IDN - Acme, Inc.
Fort Worth, TX
800-859-2263
Fax: 817-284-3501

IDN - Acme, Inc.
Houston, TX
800-359-2263
Fax: 713-668-8050

IDN - Acme, Inc.
Richardson, TX
214-664-1240
Fax: 214-664-1252

IDN - Acme, Inc.
San Antonio, TX
210-545-3396
Fax: 210-545-2198

IDN - Armstrong's, Inc.
Jacksonville, FL
800-341-7857
Fax: 904-387-4568

IDN - Armstrong's, Inc.
N. Miami Beach, FL
800-827-3332
Fax: 305-652-1709

IDN - Armstrong's, Inc.
Orlando, FL
800-775-1220
Fax: 407-297-9522

IDN - Armstrong's, Inc.
Tampa, FL
800-829-3332
Fax: 813-886-5696

IDN - Armstrong's, Inc.
Atlanta, GA
800-726-3332
Fax: 404-888-0834

IDN - Armstrong's, Inc.
Norfolk, VA
800-735-3334
Fax: 804-853-1832

IDN - Canada
Calgary, Alberta, Canada
800-813-5344
Fax: 403-291-4893

IDN - Canada
Edmonton, Alberta, Canada
403-944-0014
Fax: 403-944-0929

IDN - Canada
Ottawa, Ontario, Canada
613-749-2172
Fax: 613-749-6651

IDN - Canada
Toronto, Ontario, Canada
800-268-1306
Fax: 416-248-9945

IDN - H. Hoffman, Inc.
Davenport, IA
800-391-4633
Fax: 319-391-7949

IDN - H. Hoffman, Inc.
Chicago, IL
800-323-1918
Fax: 708-456-0878

IDN - H. Hoffman, Inc.
Indianapolis, IN
800-382-9449
Fax: 317-637-2358

IDN - H. Hoffman, Inc.
Overland Park, KS
800-526-5897
Fax: 913-599-4160

IDN - H. Hoffman, Inc.
St. Louis, MO
800-392-1303
Fax: 314-426-6389

IDN - H. Hoffman, Inc.
Cincinnati, OH
800-457-3963
Fax: 513-271-8567

IDN - H. Hoffman, Inc.
Valley View, OH
800-247-8217
Fax: 216-642-3901

IDN - H. Hoffman, Inc.
Menomonee Falls, WI
800-472-9191
Fax: 414-252-4378

IDN - Hardware Sales, Inc.
Ferndale, MI
800-468-7490
Fax: 313-545-0627



SCHWAB CORP.

Fire protection for your vital records.

**It's not safe unless
it's Schwab Safe.**

[Click here for more information](#)

Locksmith Software continued

IDN - Hardware Sales, Inc.
Grand Rapids, MI
800-244-2444
Fax: 616-534-1904

IDN - Hardware Sales, Inc.
Livonia, MI
800-521-0955
Fax: 313-591-7289

IDN - Hardware Sales, Inc.
Pittsburgh, PA
800-837-5625
Fax: 412-771-6350

IDN - M. Taylor, Inc.
Philadelphia, PA
800-233-3355
Fax: 215-288-2511

Intermountain Lock & Supply
Denver, CO
800-323-8046
Fax: 303-698-2094

J. Nathan Hardware Specialties Inc.
Rochester, NY
800-634-2580
Fax: 716-325-7196

Jack Stearman Ltd.
Vancouver, B.C., Canada
604-872-8415
Fax: 604-875-9174

Jo-Van Distributors
Scarborough, Ont., Canada
800-268-5731
Fax: 800-286-5010

Kenco Supply Co.
Omaha, NE
800-228-2266
Fax: 800-228-4175

Key Hardware Company
Los Angeles, CA
213-255-9873
Fax: 213-255-8457

Key Sales & Supply Co.
Detroit, MI
800-445-KEYS (5397)
Fax: 313-931-7758

Keys Wholesale Distributors
Drexel Hill, PA
800-292-5397
Fax: 610-626-4189

Kolson, Inc.
Great Neck, NY
800-451-5950
Fax: 516-487-1231

LDM Enterprises, Inc.
Westlake Village, CA
800-451-5950
Fax: 818-706-8560

Lock Wise Security Products
Miami, FL
800-447-6616
Fax: 305-623-9564

Locks Co.
N. Miami, FL
800-288-0801
Fax: 305-949-3619

M. Shepse Co. Div. American Bionics
Pittsburgh, PA
800-666-6007
Fax: 412-381-5122

M. Taylor Inc. - See IDN

Major Lock Supply
Fullerton, CA
714-447-8363
Fax: 714-447-8393

Mayflower Sales Co., Inc.
Brooklyn, NY
800-224-2052
Fax: 718-789-8346

Maziuk & Co., Inc.
Syracuse, NY
800-777-5945
Fax: 315-472-3111

McDonald Dash Locksmith Supply, Inc.
Memphis, TN
800-238-7541
Fax: 901-366-0005

McManus Locksmith Supply, Inc.
Charlotte, NC
NC 800-432-6342, SC 800-438-6567
Fax: 704-332-8664

Mid-South Locksmith Supply
Memphis, TN
800-238-6166
Fax: 901-795-3475

Northwest Lock & Supply Co.
Albany, OR
800-359-9425
Fax: 503-928-9338

Pasek Corp.
So. Boston, MA
800-628-2822
Fax: 617-269-0547 or 800-262-0547

Rininger Lock & Supply
Lemon Grove, CA
619-463-0170
Fax: 619-697-2590

Robert Skeels & Company
Compton, CA
800-734-4539
Fax: 310-639-7569

Safemasters Company, Inc.
Wilmington, DE
302-478-5204

Safemasters Company, Inc.
Chicago, IL
312-627-1440

Safemasters Company, Inc.
Des Plaines, IL
708-299-3420

Safemasters Company, Inc.
Boston, MA
617-423-4846

Safemasters Company, Inc.
Baltimore, MD
410-624-3300

Safemasters Company, Inc.
Silver Spring, MD
301-608-9000

Safemasters Company, Inc.
Silver Spring, MD
800-633-9977
Fax: 800-233-2454

Safemasters Company, Inc.
Barrington, NJ
609-547-4706

Safemasters Company, Inc.
Philadelphia, PA
215-561-6464

Safemasters Company, Inc.
Pittsburgh, PA
412-821-5166

Safemasters Company, Inc.
Alexandria, VA
703-354-8700

Safemasters Company, Inc.
Chesapeake, VA
804-420-0404

Safemasters Company, Inc.
Norfolk, VA
804-627-1485

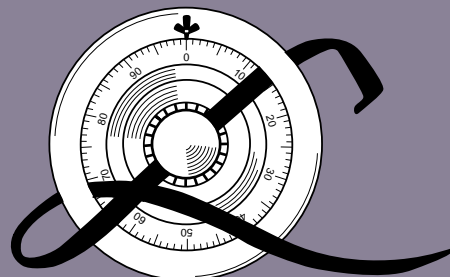
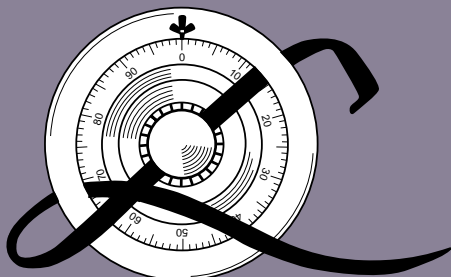

**Lockmasters has a
44 year history of
training security
professionals.**

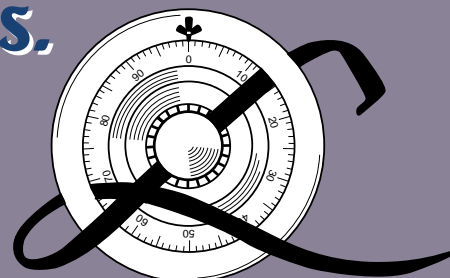
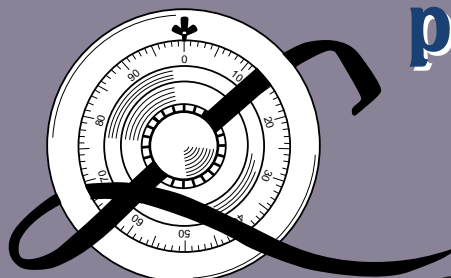

[Click here for more information](#)

Security Plus
Phoenix, AZ
800-426-0200
Fax: 602-234-3882

Serrubec Inc.
Montreal, Dorval, Canada
800-361-0243
Fax: 514-631-0494

Shield Supply & Services Ltd.
Winnipeg, Man., Canada
204-774-1921
Fax: 204-774-5627

Southern Lock & Supply Co.
Pinellas Park, FL
800-282-2837
Fax: 800-447-2299

Southern Lock and Supply Co.
Miami, FL
305-885-5779
Fax: 305-885-8798

Southern Lock and Supply Co.
Oakland Park, FL
305-568-9669
Fax: 305-568-3397

Southern Lock and Supply Co.
Atlanta, GA
404-455-9233
Fax: 404-455-3969

Southern Lock and Supply Co.
Charlotte, NC
704-527-6777
Fax: 704-527-0058

Stone & Berg Wholesale Locksmith
Supply
Worcester, MA
800-225-7405
Fax: 800-535-5625

Taylor Security & Lock Co., Inc.
Gaithersburg, MD
800-676-7670
Fax: 301-948-1029

The Locksmith Store, Inc.
Arlington Heights, IL
800-547-5111
Fax: 708-364-5125

Wholesale 4 Inc.
Portland, OR
800-547-0921
Fax: 503-235-5636

Wilco Supply
Oakland, CA
800-745-5450
Fax: 510-653-5397

Zipf Lock Co.
Columbus, OH
800-848-1577
Fax: 800-228-6320

Electronic Security Products

A.T. Jones & Son
Detroit, MI
800-735-4570
Fax: 313-965-1093

Access Safe & Supply Ltd.
Burlington, Ont., Canada
800-268-9033
Fax: 905-319-0366

Accredited Lock Supply Co.
Secaucus, NJ
800-652-2835
Fax: 201-865-5031

Ace Lock & Security Supply
Union, NJ
800-223-5625
Fax: 908-688-2442

Acme Security Systems
San Leandro, CA
800-348-2263
Fax: 800-435-8233

Acme Wholesale Dist. - See IDN

Agences W. Pelletier (1980) Inc.
Montreal, Quebec, Canada
800-363-6700
Fax: 514-276-9413

American Access Supply, LA Div.
Los Angeles, CA
800-858-1726
Fax: 310-568-1507

American Access Supply
Seattle, WA
800-559-9634
Fax: 800-243-3049

American Lock & Key Co.
Richmond, VA
800-995-6247
Fax: 804-282-1007

American Lock & Supply
Boston, MA
800-291-2797
Fax: 800-291-2798

American Lock & Supply, Inc.
Phoenix, AZ
800-826-6968
Fax: 602-254-0272, 800-325-3728

American Lock & Supply, Inc.
Anaheim, CA
800-854-8775
Fax: 714-579-7554

American Lock & Supply, Inc.
Fremont, CA
800-227-1142
Fax: 510-651-2350, 800-662-4399

American Lock & Supply, Inc.
San Diego, CA
800-231-8435
Fax: 800-788-0916

American Lock & Supply, Inc.
Denver, CO
800-346-5549
Fax: 303-733-0202, 800-241-0202

American Lock & Supply, Inc.
Atlanta, GA
800-952-4452
Fax: 404-458-0899, 800-358-4561

American Lock & Supply, Inc.
Elmhurst, IL
800-621-0177
Fax: 708-832-9084, 800-238-5397

American Lock & Supply, Inc.
Kansas City, KS
800-888-5625
Fax: 913-432-1342, 800-395-7945

American Lock & Supply, Inc.
Elkridge, MD
800-358-6398
Fax: 410-379-5990, 800-358-6399

American Lock & Supply, Inc.
Hauppauge, NY
800-628-5625
Fax: 516-231-2019, 800-424-7185

American Lock & Supply, Inc.
Dallas, TX
800-292-0115
Fax: 214-358-6037, 800-527-3028

American Lock & Supply, Inc.
Houston, TX
800-435-8105
Fax: 713-681-0850, 800-435-8232

Continued on page 51

DISTRIBUTORS by PRODUCT



HPC, Inc.
Designing Excellence and Manufacturing
Quality since 1956

[Click here for more information](#)

**Electronic Security Products
Continued from page 47**

American Lock & Supply, Inc.
Seattle, WA
800-356-5661
Fax: 206-431-8527, 800-392-1132

Anderson Lock Co.
Des Plaines, IL
708-296-1157
Fax: 708-296-9259

Apex Security Hardware Corp.
Brooklyn, NY
800-232-1117
Fax: 718-438-3327, 800-951-7000

Armstrong's Lock & Supply Inc. - See
IDN

Associated Lock & Supply
Port Coquitlam, BC, Canada
800-373-5754
Fax: 604-942-3761

Automatic Gate Wholesalers
Modesto, CA
800-238-2301
Fax: 800-438-2301

Autotech Accessories, Inc.
Brooklyn, NY
718-680-8901
Fax: Automatic

Bell's Security Sales
Bloomfield, NJ
800-772-2266
Fax: 201-743-6357

Blaydes Lock Co., Inc.
Washington, DC
800-424-2650
Fax: 202-832-1359

Boston Lock & Safe Co., Inc.
Brighton, MA
800-252-5757
Fax: 617-787-3425

Boyle & Chase, Inc.
Accord, MA
800-325-2530
Fax: 617-335-5342

Brook's Lock & Key, Inc.
Decatur, AL
800-292-5008
Fax: 205-353-8260

Brooks Supply, Inc.
Oklahoma City, OK
800-347-4477
Fax: 405-672-7575

Canada Lock Products - See IDN

Citizens Defensive Products
St. Joseph, MO
816-233-1512
Fax: 816-233-3092

City Intercoms, Inc.
New York, NY
800-248-9468
Fax: 800-598-2865

Clark Security Products
Phoenix, AZ
800-775-5625
Fax: 602-275-9235

Clark Security Products
Bell, CA
800-889-5625
Fax: 213-262-0741

Clark Security Products
San Diego, CA
800-854-2088
Fax: 619-565-4605

Clark Security Products
San Diego, CA
800-854-2088
Fax: 619-565-4605

Clark Security Products
W. Sacramento, CA
800-245-3003
Fax: 916-372-7221

Clark Security Products
Denver, CO
800-282-5625
Fax: 800-699-3329

Clark Security Products
Wood Dale, IL
800-755-5625
Fax: 708-350-8535

Clark Security Products
Auburn, MA
800-746-5625
Fax: 800-596-5625

Clark Security Products
Lanham, MD
800-578-5625
Fax: 800-378-5625

Clark Security Products
Salt Lake City, UT
800-453-6430
Fax: 801-487-3254

Clark Security Products
Seattle, WA
800-942-5275
Fax: 800-546-5625

Closed Circuit Designs
N. Miami Beach, FL
800-228-8321
Fax: 305-652-3471

Colonial Lock Supply Co., Inc.
Newington, VA
800-732-9117
Fax: 703-550-8857

Commonwealth Lock Co.
Cambridge, MA
800-442-7009
Fax: 617-661-3168

Craftmaster Hardware Co., Inc.
Hackensack, NJ
800-221-3212
Fax: 201-646-0181

Cypress Security Products Ltd.
Calgary, AB, Canada
800-561-1967
Fax: 403-250-1969

Dealer Connection, Inc.
Naperville, IL
800-500-4500
Fax: 708-717-2805

Doyle Lock Supply, Inc.
Minneapolis, MN
800-333-6953
Fax: 612-521-0166

Dugmore & Duncan of California
Riverside, CA
800-325-1595
Fax: 909-360-0572

Dugmore and Duncan of California
Riverside, CA
800-325-1595
Fax: 909-360-0572

Dugmore and Duncan of Florida
Lakeland, FL
800-232-1595
Fax: 813-666-5226

Dugmore and Duncan, Inc.
Hingham, MA
800-225-1595
Fax: 617-740-4043

E.L. Reinhardt
Vadnais Heights, MN
800-328-1311
Fax: 612-481-0166

Edw. Saucedo & Son Co., Inc.
El Paso, TX
800-248-3726
Fax: 915-566-8608

Elly Express
Wheeling, IL
800-432-1311
Fax: 708-480-1383

EMG Associates
Chicago, IL
800-468-3558
Fax: 312-649-0787

Empire Security Supplies
Pt. Jefferson Station, NY
516-928-1919
Fax: 516-928-4745

Ewert Wholesale Hardware Inc.
Alsip, IL
800-451-0200
Fax: 708-597-0881

Express Hardware
Barrington, IL
800-323-7447
Fax: 708-381-7199

Fairway Supply, Inc.
Houston, TX
800-767-3247
Fax: 713-957-2122

Fastrack Hardware, Inc.
Brookfield, WI
800-458-8707
Fax: 800-667-8701

Fortress Safe & Lock
Cincinnati, OH
800-562-0295
Fax: 513-772-5276

Fradon Lock Co., Inc.
Syracuse, NY
800-447-0591
Fax: 315-472-0958

Fried Bros. Inc.
Philadelphia, PA
800-523-2924
Fax: 215-592-1255

Gamalski Building Specialties
Auburn Hills, MI
810-852-7050
Fax: 810-852-8390

Great Lakes Lock Distributors
Erie, PA
800-543-8837
Fax: 814-456-1542

H. Hoffman Co. - See IDN

H.E. Mitchell Co.
Portland, OR
800-626-5625
Fax: 503-238-5715

H.S. & S. Wholesale Dist. of Lock
Hdwe.
Detroit, MI
800-342-2202
Fax: 313-342-7580

Hans Johnsen Co.
Dallas, TX
800-678-1560
Fax: 879-1530 or 800-967-4250

Hardware Agencies Ltd.
Toronto, Ont., Canada
800-268-6741
Fax: 416-462-1922

Hardware Sales & Supply - See IDN

Hardware Specialties, Inc.
Dubois, PA
800-872-7893
Fax: 814-371-0590

Herbert Flake Co.
Houston, TX
800-231-4105
Fax: 713-926-3399

Howard Sales Co.
El Paso, TX
800-456-4625
Fax: 915-833-7770

IDN - Acme, Inc.
Phoenix, AZ
800-525-3131
Fax: 602-241-0249

IDN - Acme, Inc.
Denver, CO
800-445-4008
Fax: 303-292-4369

IDN - Acme, Inc.
New Orleans, LA
800-788-2263
Fax: 504-837-7321

IDN - Acme, Inc.
Oklahoma City, OK
405-942-8750
Fax: 405-942-0523

IDN - Acme, Inc.
Fort Worth, TX
800-859-2263
Fax: 817-284-3501

IDN - Acme, Inc.
Houston, TX
800-359-2263
Fax: 713-668-8050

IDN - Acme, Inc.
Richardson, TX
214-664-1240
Fax: 214-664-1252

IDN - Acme, Inc.
San Antonio, TX
210-545-3396
Fax: 210-545-2198

IDN - Armstrong's, Inc.
Jacksonville, FL
800-341-7857
Fax: 904-387-4568

IDN - Armstrong's, Inc.
N. Miami Beach, FL
800-827-3332
Fax: 305-652-1709

IDN - Armstrong's, Inc.
Orlando, FL
800-775-1220
Fax: 407-297-9522

IDN - Armstrong's, Inc.
Tampa, FL
800-829-3332
Fax: 813-886-5696

IDN - Armstrong's, Inc.
Atlanta, GA
800-726-3332
Fax: 404-888-0834

IDN - Armstrong's, Inc.
Norfolk, VA
800-853-1832

IDN - Canada
Calgary, Alberta, Canada
800-813-5344
Fax: 403-291-4893

IDN - Canada
Edmonton, Alberta, Canada
403-944-0014
Fax: 403-944-0929

IDN - Canada
Ottawa, Ontario, Canada
613-749-2172
Fax: 613-749-6651

IDN - Canada
Toronto, Ontario, Canada
800-268-1306
Fax: 416-248-9945

IDN - H. Hoffman, Inc.
Davenport, IA
800-391-4633
Fax: 319-391-7949

IDN - H. Hoffman, Inc.
Chicago, IL
800-323-1918
Fax: 708-456-0878

Electronic Security Products continued

IDN - H. Hoffman, Inc.
Indianapolis, IN
800-382-9449
Fax: 317-637-2358

IDN - H. Hoffman, Inc.
Overland Park, KS
800-526-5897
Fax: 913-599-4160

IDN - H. Hoffman, Inc.
St. Louis, MO
800-392-1303
Fax: 314-426-6389

IDN - H. Hoffman, Inc.
Cincinnati, OH
800-457-3963
Fax: 513-271-8567

IDN - H. Hoffman, Inc.
Valley View, OH
800-247-8217
Fax: 216-642-3901

IDN - H. Hoffman, Inc.
Menomonee Falls, WI
800-472-9191
Fax: 414-252-4378

IDN - Hardware Sales, Inc.
Ferndale, MI
800-468-7490
Fax: 313-545-0627

IDN - Hardware Sales, Inc.
Grand Rapids, MI
800-244-2444
Fax: 616-534-1904

IDN - Hardware Sales, Inc.
Livonia, MI
800-521-0955
Fax: 313-591-7289

IDN - Hardware Sales, Inc.
Pittsburgh, PA
800-837-5625
Fax: 412-771-6350

IDN - M. Taylor, Inc.
Philadelphia, PA
800-233-3355
Fax: 215-288-2511

Independent Hardware Inc.
Philadelphia, PA
800-346-9464
Fax: 215-922-6552

Intermountain Lock & Supply
Denver, CO
800-323-8046
Fax: 303-698-2094

Island Pacific Distributors, Inc.
Honolulu, HI
808-955-1126
Fax: 808-946-6480

J. Nathan Hardware Specialties Inc.
Rochester, NY
800-634-2580
Fax: 716-325-7196

Jack Stearman Ltd.
Vancouver, B.C., Canada
604-872-8415
Fax: 604-875-9174

JLM Wholesale, Inc.
Oxford, MI
800-522-2940
Fax: 800-782-1160

Jo-Van Distributors
Scarborough, Ont., Canada
800-268-5731
Fax: 800-286-5010

Johansson Wholesale
Tampa, FL
800-854-3320
Fax: 800-808-2281

K & K Supply, Inc.
Upland, CA
800-233-7772
Fax: 909-920-0402

Kenco Supply Co.
Omaha, NE
800-228-2266
Fax: 800-228-4175

Key Hardware Company
Los Angeles, CA
213-255-9873
Fax: 213-255-8457

Key Sales & Supply Co.
Detroit, MI
800-445-KEYS (5397)
Fax: 313-931-7758

Keystone Safe Distributors
Huntingdon Valley, PA
800-755-2893
Fax: 215-627-6419

Kramer Boys Locksmith Supply
Trenton, NJ
800-222-2692
Fax: 609-586-0512

Lock Wise Security Products
Miami, FL
800-447-6616
Fax: 305-623-9564

Lockmasters Inc.
Nicolasville, KY
800-654-0637
Fax: 606-885-7093

Locks Co.
N. Miami, FL
800-288-0801
Fax: 305-949-3619

M. Shepse Co. Div. American Bionics
Pittsburgh, PA
800-666-6007
Fax: 412-381-5122

M. Taylor Inc. - See IDN
Major Lock Supply
Fullerton, CA
714-447-8363
Fax: 714-447-8393

Mayflower Sales Co., Inc.
Brooklyn, NY
800-224-2052
Fax: 718-789-8346

Maziuk & Co., Inc.
Syracuse, NY
800-777-5945
Fax: 315-472-3111

McDonald Dash Locksmith Supply, Inc.
Memphis, TN
800-238-7541
Fax: 901-366-0005

McManus Locksmith Supply, Inc.
Charlotte, NC
NC 800-432-6342, SC 800-438-6567
Fax: 704-332-8664

Mid-South Locksmith Supply
Memphis, TN
800-238-6166
Fax: 901-795-3475

Midland Land Mobile Radio
Kansas City, MO
800-MIDLAND x1690
Fax: 816-920-1144

Midwest Wholesale Distributors
Kansas City, MO
800-821-8527
Fax: 800-621-6581

Midwest Wholesale Hardware
Orlando, FL
800-659-8527
Fax: 800-659-6581

Monaco Lock Company, Inc.
Jersey City, NJ
800-526-6094
Fax: 800-845-LOCK

Northwest Lock & Supply Co.
Albany, OR
800-359-9425
Fax: 503-928-9338

DISTRIBUTORS by PRODUCT

M **Major**
MANUFACTURING, INC.

Installation Tools

The Professionals Choice

[Click here for more information](#)

Omaha Wholesale Hdwe.
Omaha, NE
800-238-4566
Fax: 800-538-4566

Pasek Corp.
So. Boston, MA
800-628-2822
Fax: 617-269-0547 or 800-262-0547

Protection Group, Inc.
Clearwater, FL
813-785-0642
Fax: 813-784-9279

Richardson Electronics, Ltd.
La Fox, IL
800-348-5580
Fax: 708-208-2550

Ringer Lock & Supply
Lemon Grove, CA
619-463-0170
Fax: 619-697-2590

Robert Skeels & Company
Compton, CA
800-734-4539
Fax: 310-639-7569

S & J Products & Services
Yakima, WA
800-735-1797
Fax: 509-575-1875

Safemasters Company, Inc.
Wilmington, DE
302-478-5204

Safemasters Company, Inc.
Chicago, IL
312-627-1440

Safemasters Company, Inc.
Des Plaines, IL
708-299-3420

Safemasters Company, Inc.
Boston, MA
617-423-4846

Safemasters Company, Inc.
Baltimore, MD
410-624-3300

Safemasters Company, Inc.
Silver Spring, MD
800-633-9977
Fax: 800-233-2454

Safemasters Company, Inc.
Silver Spring, MD
301-608-9000

Safemasters Company, Inc.
Barrington, NJ
609-547-4706

Safemasters Company, Inc.
Philadelphia, PA
215-561-6464

Safemasters Company, Inc.
Pittsburgh, PA
412-821-5166

Safemasters Company, Inc.
Alexandria, VA
703-354-8700

Safemasters Company, Inc.
Chesapeake, VA
804-420-0404

Safemasters Company, Inc.
Norfolk, VA
804-627-1485

Security Equipment Supply
Des Plaines, IL
800-729-1306
Fax: 708-803-2143

Security Equipment Supply
Lenexa, KS
800-779-2865
Fax: 913-599-3716

Security Equipment Supply
Madison Heights, MI
800-548-0680
Fax: 810-543-5576

Security Equipment Supply
Earth City, MO
800-325-0221
Fax: 314-298-8962

Security Equipment Supply
Memphis, TN
800-475-4850
Fax: 901-365-8356

Security House Padlock Distributors
Concord, Ont., Canada
800-567-5300 "Canada wide"
Fax: 905-660-6313

Security Lock Distributors
Needham Heights, MA
800-847-5625
Fax: 800-878-6400

Security Plus
Phoenix, AZ
800-426-0200
Fax: 602-234-3882

Sentinel Wholesale Hdwe. Sen. Div.
Ind.
E. Farmingdale, NY
800-526-9000
Fax: 516-753-6004

Serrubec Inc.
Montreal, Dorval, Canada
800-361-0243
Fax: 514-631-0494

Shield Supply & Services Ltd.
Winnipeg, Man., Canada
204-774-1921
Fax: 204-774-5627

Southern Lock & Supply Co.
Pinellas Park, FL
800-282-2837
Fax: 800-447-2299

Southern Lock and Supply Co.
Miami, FL
305-885-5779
Fax: 305-885-8798

Southern Lock and Supply Co.
Oakland Park, FL
305-568-9669
Fax: 305-568-3397

Southern Lock and Supply Co.
Atlanta, GA
404-455-9233
Fax: 404-455-3699

Southern Lock and Supply Co.
Charlotte, NC
704-527-6777
Fax: 704-527-0058

Standard Wholesale Hardware Inc.
New York, NY
800-543-5625
Fax: 212-420-9892

Stone & Berg Wholesale Locksmith
Supply
Worcester, MA
800-225-7405
Fax: 800-535-5625

Taylor Security & Lock Co., Inc.
Gaithersburg, MD
800-676-7670
Fax: 301-948-1029

DISTRIBUTORS by PRODUCT



**ASP - Your Auto Service
Center for the World**

[Click here for more information](#)

It's your
reputation.



STRATTEC™

Trust the
original.

[Click here for more information](#)

Electronic Security Products continued

Timemasters
Topeka, KS
913-232-8705
Fax: 800-798-TIME

Transwest Hardware Sales
Vancouver, B.C., Canada
800-567-1177
Fax: 604-253-5344

Tweed's Security Hardware
Wholesalers
Portsmouth, VA
800-544-4482
Fax: 804-399-1636

Wadsworth White Inc.
Atlanta, GA
800-458-9449
Fax: 404-458-2253

Wholesale 4 Inc.
Portland, OR
800-547-0921
Fax: 503-235-5636

Wilco Supply
Oakland, CA
800-745-5450
Fax: 510-653-5397

Zipf Lock Co.
Colombus, OH
800-848-1577
Fax: 800-228-6320

Locking Products

A.T. Jones & Son
Detroit, MI
800-735-4570
Fax: 313-965-1093

Access Safe & Supply Ltd.
Burlington, Ont., Canada
800-268-9033
Fax: 905-319-0366

Accredited Lock Supply Co.
Secaucus, NJ
800-652-2835
Fax: 201-865-5031

Ace Lock & Security Supply
Union, NJ
800-223-5625
Fax: 908-688-2442

Acme Security Systems
San Leandro, CA
800-348-2263
Fax: 800-435-8233

Acme Wholesale Dist. - See IDN

Adams Lock & Safe Co., Inc.
Concord, NH
800-635-2228
Fax: 603-226-4983

Agences W. Pelletier (1980) Inc.
Montreal, Quebec, Canada
800-363-6700
Fax: 514-276-9413

Akron Hdw. Consultants
Akron, OH
800-321-9602
Fax: 800-328-6070

Allied Locksmith Supply
Youngstown, OH
800-544-2102
Fax: 216-726-0865

American Access Supply, LA Div.
Los Angeles, CA
800-858-1726
Fax: 310-568-1507

American Access Supply
Seattle, WA
800-559-9634
Fax: 800-243-3049

American Lock & Key Co.
Richmond, VA
800-995-6247
Fax: 804-282-1007

American Lock & Supply
Boston, MA
800-291-2797
Fax: 800-291-2798

American Lock & Supply, Inc.
Phoenix, AZ
800-826-6968
Fax: 602-254-0272, 800-325-3728

American Lock & Supply, Inc.
Anaheim, CA
800-854-8775
Fax: 714-579-7554

American Lock & Supply, Inc.
Fremont, CA
800-227-1142
Fax: 510-651-2350, 800-662-4399

American Lock & Supply, Inc.
San Diego, CA
800-231-8435
Fax: 800-788-0916

American Lock & Supply, Inc.
Denver, CO
800-346-5549
Fax: 303-733-0202, 800-241-0202

American Lock & Supply, Inc.
Atlanta, GA
800-952-4452
Fax: 404-458-0899, 800-358-4561

American Lock & Supply, Inc.
Elmhurst, IL
800-621-0177
Fax: 708-832-9084, 800-238-5397

American Lock & Supply, Inc.
Kansas City, KS
800-888-5625
Fax: 913-432-1342, 800-395-7945

American Lock & Supply, Inc.
Elkridge, MD
800-358-6398
Fax: 410-379-5990, 800-358-6399

American Lock & Supply, Inc.
Hauppauge, NY
800-628-5625
Fax: 516-231-2019, 800-424-7185

American Lock & Supply, Inc.
Dallas, TX
800-292-0115
Fax: 214-358-6037, 800-527-3028

American Lock & Supply, Inc.
Houston, TX
800-435-8105
Fax: 713-681-0850, 800-435-8232

American Lock & Supply, Inc.
Seattle, WA
800-356-5661
Fax: 206-431-8527, 800-392-1132

Amos Lock & Key Supply Co.
Fort Worth, TX
800-772-7432
Fax: 317-335-5399

Anderson Lock Co.
Des Plaines, IL
708-296-1157
Fax: 708-296-9259

Andrew's Wholesale Lock Supply
Lebanon, PA
800-544-0519
Fax: 717-274-8659

Anytime Security Products
Hermosa Beach, CA
800-539-2427
Fax: 310-798-4604

Apex Security Hardware Corp.
Brooklyn, NY
800-232-1117
Fax: 718-438-3327, 800-951-7000

Architectural Products By Outwater,
L.L.C.
Woodridge, NJ
800-835-4400
Fax: 800-835-4403

Aristo Sales Co., Inc.
Long Island City, NY
800-221-1322
Fax: 718-937-5794

Armstrong's Lock & Supply Inc. - See IDN

ASLA Distributing
East Rockaway, NJ
516-766-2863
Fax: 516-766-2863

Associated Lock & Supply
Port Coquillam, BC, Canada
800-373-5754
Fax: 604-942-3761

Automatic Gate Wholesalers
Modesto, CA
800-238-2301
Fax: 800-438-2301

Autotech Accessories, Inc.
Brooklyn, NY
718-680-8901
Fax: Automatic

Avco Key Supply
Northport, NY
800-332-5397
Fax: 800-329-5397

Bell's Security Sales
Bloomfield, NJ
800-772-2266
Fax: 201-743-6357

Blaydes Lock Co., Inc.
Washington, DC
800-424-2650
Fax: 202-832-1359

Boston Lock & Safe Co., Inc.
Brighton, MA
800-252-5757
Fax: 617-787-3425

Boyle & Chase, Inc.
Accord, MA
800-325-2530
Fax: 617-335-5342

Brady Office Machine Security
Chicago, IL
800-326-8349
Fax: 312-779-9712

Brook's Lock & Key, Inc.
Decatur, AL
800-292-5008
Fax: 205-353-8260

Brooks Supply, Inc.
Oklahoma City, OK
800-347-4477
Fax: 405-672-7575

Buffalo Safe & Lock
W. Seneca, NY
800-255-6257
Fax: 716-674-4645

C & M Tool
Fremont, CA
510-792-6613

C.E. Sanders
Lutz, FL
813-948-3162
Fax: 813-949-1874

Canada Lock Products - See IDN

Capitol Lock Co., Inc.
College Park, MD
301-513-9500
Fax: 301-513-9505

City Lock Supply
Boulder, CO
303-444-4407
Fax: 303-442-8380

Clark Security Products
Phoenix, AZ
800-775-5625
Fax: 602-275-9235

Clark Security Products
Bell, CA
800-889-5625
Fax: 213-262-0741

Clark Security Products
San Diego, CA
800-854-2088
Fax: 619-565-4605

Clark Security Products
San Diego, CA
800-854-2088
Fax: 619-565-4605

Clark Security Products
W. Sacramento, CA
800-245-3003
Fax: 916-372-7221

Clark Security Products
Denver, CO
800-282-5625
Fax: 800-699-3329

Clark Security Products
Wood Dale, IL
800-755-5625
Fax: 708-350-8535

Clark Security Products
Auburn, MA
800-746-5625
Fax: 800-596-5625

Clark Security Products
Lanham, MD
800-578-5625
Fax: 800-378-5625

Clark Security Products
Salt Lake City, UT
800-453-6430
Fax: 801-487-3254

Clark Security Products
Seattle, WA
800-942-5275
Fax: 800-546-5625

Colonial Lock Supply Co., Inc.
Newington, VA
800-732-9117
Fax: 703-550-8857

Commonwealth Lock Co.
Cambridge, MA
800-442-7009
Fax: 617-661-3168

Cook's Building Specialties, Inc.
Albuquerque, NM
505-883-5701
Fax: 505-883-5704

Craftmaster Hardware Co., Inc.
Hackensack, NJ
800-221-3212
Fax: 201-646-0181

Cypress Security Products Ltd.
Calgary, AB, Canada
800-561-1967
Fax: 403-250-1969

DiMark International
Santa Maria, CA
800-235-2435
Fax: 805-928-8034

Doyle Lock Supply, Inc.
Minneapolis, MN
800-333-6953
Fax: 612-521-0166

Dugmore & Duncan of California
Riverside, CA
800-325-1595
Fax: 909-360-0572

Dugmore and Duncan of Florida
Lakeland, FL
800-232-1595
Fax: 813-666-5226

Dugmore and Duncan, Inc.
Hingham, MA
800-225-1595
Fax: 617-740-4043

medeco[®]
HIGH SECURITY LOCKS

The market leader
in locking systems
for security,
safety, and control.

[Click here for more information](#)

DISTRIBUTORS by PRODUCT

Locking Products continued

E.L. Reinhardt
Vadnais Heights, MN
800-328-1311
Fax: 612-481-0166

Edw. Saucedo & Son Co., Inc.
El Paso, TX
800-248-3726
Fax: 915-566-8608

ElJay Express
Wheeling, IL
800-432-1311
Fax: 708-480-1383

EMG Associates
Chicago, IL
800-468-3558
Fax: 312-649-0787

Empire Security Supplies
Pt. Jefferson Station, NY
516-928-1919
Fax: 516-928-4745

Enixus Trade, Ltd.
St. Catharines, Ont., Canada
905-682-3086
Fax: 905-682-3086

Ewert Wholesale Hardware Inc.
Alsip, IL
800-451-0200
Fax: 708-597-0881

Express Hardware
Barrington, IL
800-323-7447
Fax: 708-381-7199

Fairway Supply, Inc.
Houston, TX
800-767-3247
Fax: 713-957-2122

Fastrack Hardware, Inc.
Brookfield, WI
800-458-8707
Fax: 800-667-8701

Foley Belsaw Co., Locksmith Division
Kansas City, MO
800-821-3452
Fax: 816-483-5010

Fortress Safe & Lock
Cincinnati, OH
800-562-0295
Fax: 513-772-5276

Fradon Lock Co., Inc.
Syracuse, NY
800-447-0591
Fax: 315-472-0958

Fried Bros. Inc.
Philadelphia, PA
800-523-2924
Fax: 215-592-1255

Grace's Wholesale & Supply Div.
Hastings, NE
402-462-2737

Great Lakes Lock Distributors
Erie, PA
800-543-8837
Fax: 814-456-1542

H & H Lock & Security Wholesalers
Gailthersburg, MD
800-772-9811
Fax: 301-948-5265

H. Hoffman Co. - See IDN

H.E. Mitchell Co.
Portland, OR
800-626-5625
Fax: 503-238-5715

H.S. & S. Wholesale Dist. of Lock
Hdwe.
Detroit, MI
800-342-2202
Fax: 313-342-7580

Hans Johnsen Co.
Dallas, TX
800-678-1560
Fax: 879-1530 or 800-967-4250

Hardware Agencies Ltd.
Toronto, Ont., Canada
800-268-6741
Fax: 416-462-1922

Hardware Sales & Supply - See IDN

Hardware Specialties, Inc.
Dubois, PA
800-872-7893
Fax: 814-371-0590

Hardware Suppliers of America, Inc.
Fresno, CA
800-334-5625

Hardware Suppliers of America, Inc.
Oldsmar, FL
800-282-8499

Hardware Suppliers of America, Inc.
Cumming, GA
800-358-6016

Hardware Suppliers of America, Inc.
Winterville, NC
800-334-5625
Fax: 800-334-5635

Hardware Suppliers of America, Inc.
Manfield, OH
800-334-5625

Hardware Suppliers of America, Inc.
Irving, TX
800-334-5625

Hardware Suppliers of America, Inc. (HSI)
Winterville, NC
800-334-5625
Fax: 800-334-5635

Herbert Flake Co.
Houston, TX
800-231-4105
Fax: 713-926-3399

Howard Sales Co.
El Paso, TX
800-456-4625
Fax: 915-833-7770

IDN - Acme, Inc.
Phoenix, AZ
800-525-3131
Fax: 602-241-0249

IDN - Acme, Inc.
Denver, CO
800-445-4008
Fax: 303-292-4369

IDN - Acme, Inc.
New Orleans, LA
800-788-2263
Fax: 504-837-7321

IDN - Acme, Inc.
Oklahoma City, OK
405-942-8750
Fax: 405-942-0523

IDN - Acme, Inc.
Fort Worth, TX
800-859-2263
Fax: 817-284-3501

IDN - Acme, Inc.
Houston, TX
800-359-2263
Fax: 713-668-8050

IDN - Acme, Inc.
Richardson, TX
214-664-1240
Fax: 214-664-1252

IDN - Acme, Inc.
San Antonio, TX
210-545-3396
Fax: 210-545-2198

IDN - Armstrong's, Inc.
Jacksonville, FL
800-341-7857
Fax: 904-387-4568

IDN - Armstrong's, Inc.
N. Miami Beach, FL
800-827-3332
Fax: 305-652-1709

IDN - Armstrong's, Inc.
Orlando, FL
800-775-1220
Fax: 407-297-9522

IDN - Armstrong's, Inc.
Tampa, FL
800-829-3332
Fax: 813-886-5696

IDN - Armstrong's, Inc.
Atlanta, GA
800-726-3332
Fax: 404-888-0834

IDN - Armstrong's, Inc.
Norfolk, VA
800-735-3334
Fax: 804-853-1832

IDN - Canada
Calgary, Alberta, Canada
800-813-5344
Fax: 403-291-4893

IDN - Canada
Edmonton, Alberta, Canada
403-944-0014
Fax: 403-944-0929

IDN - Canada
Ottawa, Ontario, Canada
613-749-2172
Fax: 613-749-6651

IDN - Canada
Toronto, Ontario, Canada
800-268-1306
Fax: 416-248-9945

IDN - H. Hoffman, Inc.
Davenport, IA
800-391-4633
Fax: 319-391-7949

IDN - H. Hoffman, Inc.
Chicago, IL
800-323-1918
Fax: 708-456-0878

IDN - H. Hoffman, Inc.
Indianapolis, IN
800-382-9449
Fax: 317-637-2358

IDN - H. Hoffman, Inc.
Overland Park, KS
800-526-5897
Fax: 913-599-4160

IDN - H. Hoffman, Inc.
St. Louis, MO
800-392-1303
Fax: 314-426-6389

IDN - H. Hoffman, Inc.
Cincinnati, OH
800-457-3963
Fax: 513-271-8567

IDN - H. Hoffman, Inc.
Valley View, OH
800-247-8217
Fax: 216-642-3901

IDN - H. Hoffman, Inc.
Menomonee Falls, WI
800-472-9191
Fax: 414-252-4378

IDN - Hardware Sales, Inc.
Ferndale, MI
800-468-7490
Fax: 313-545-0627

IDN - Hardware Sales, Inc.
Grand Rapids, MI
800-244-2444
Fax: 616-534-1904

IDN - Hardware Sales, Inc.
Livonia, MI
800-521-0955
Fax: 313-591-7289

IDN - Hardware Sales, Inc.
Pittsburgh, PA
800-837-5625
Fax: 412-771-6350

IDN - M. Taylor, Inc.
Philidelphia, PA
800-233-3355
Fax: 215-288-2511

Independent Hardware Inc.
Philadelphia, PA
800-346-9464
Fax: 215-922-6552

Intermountain Lock & Supply
Denver, CO
800-323-8046
Fax: 303-698-2094

International Door Closers, Inc.
Nashville, TN
800-225-6737
Fax: 615-885-0903

Island Pacific Distributors, Inc.
Honolulu, HI
808-955-1126
Fax: 808-946-6480

J & J Distributors
San Antonio, TX
210-734-6165
Fax: 210-735-2248

J. Nathan Hardware Specialties Inc.
Rochester, NY
800-634-2580
Fax: 716-325-7196

Jack Stearman Ltd.
Vancouver, B.C., Canada
604-872-8415
Fax: 604-875-9174

Jo-Van Distributors
Scarborough, Ont., Canada
800-268-5731
Fax: 800-286-5010

Johansson Wholesale
Tampa, FL
800-854-3320
Fax: 800-808-2281

K & K Supply, Inc.
Upland, CA
800-233-7772
Fax: 909-920-0402

Kenco Supply Co.
Omaha, NE
800-228-2266
Fax: 800-228-4175

Key Hardware Company
Los Angeles, CA
213-255-9873
Fax: 213-255-8457

Key Mart Inc.
Stuart, FL
800-228-7755
Fax: 407-220-7920

Key Sales & Supply Co.
Detroit, MI
800-445-KEYS (5397)
Fax: 313-931-7758

Keys Plus Distributing
Tonawanda, NY
716-743-0220

Keys Wholesale Distributors
Drexel Hill, PA
800-292-5397
Fax: 610-626-4189

Continued on page 58

**Locking Products
Continued from page 56**

Keystone Safe Distributors
Huntingdon Valley, PA
800-755-2893
Fax: 215-627-6419

Kolson, Inc.
Great Neck, NY
800-783-1335
Fax: 516-487-1231

Kramer Boys Locksmith Supply
Trenton, NJ
800-222-2692
Fax: 609-586-0512

LDM Enterprises, Inc.
Westlake Village, CA
800-451-5950
Fax: 818-706-8560

Lock Wise Security Products
Miami, FL
800-447-6616
Fax: 305-623-9564

Lockmasters Inc.
Nicolasville, KY
800-654-0637
Fax: 606-885-7093

Locks Co.
N. Miami, FL
800-288-0801
Fax: 305-949-3619

M. Shepse Co. Div. American Bionics
Pittsburgh, PA
800-666-6007
Fax: 412-381-5122

M. Taylor Inc. - See IDN

Major Lock Supply
Fullerton, CA
714-447-8363
Fax: 714-447-8393

Mayflower Sales Co., Inc.
Brooklyn, NY
800-224-2052
Fax: 718-789-8346

Maziuk & Co., Inc.
Syracuse, NY
800-777-5945
Fax: 315-472-3111

McDonald Dash Locksmith Supply, Inc.
Memphis, TN
800-238-7541
Fax: 901-366-0005

McManus Locksmith Supply, Inc.
Charlotte, NC
NC 800-432-6342, SC 800-438-6567
Fax: 704-332-8664

Meister Atlanta Corp.
Atlanta, GA
404-451-5305

Mid-South Locksmith Supply
Memphis, TN
800-238-6166
Fax: 901-795-3475

Midwest Wholesale Distributors
Kansas City, MO
800-821-8527
Fax: 800-621-6581

Monaco Lock Company, Inc.
Jersey City, NJ
800-526-6094
Fax: 800-845-LOCK

New York Locksmith Supply Co., Inc.
New York, NY
212-737-0178, 914-328-1919
Fax: 212-988-9192

Northwest Lock & Supply Co.
Albany, OR
800-359-9425
Fax: 503-928-9338

Ohio Travel Bag Mfg. Co.
Solon, OH
216-498-1955
Fax: 216-498-9811

Omaha Wholesale Hdwe.
Omaha, NE
800-238-4566
Fax: 800-538-4566

Orchard Lock Distributors, Inc.
Hamden, CT
800-233-2146
Fax: 203-624-4083

Orion Pacific Trading Company
Irvine, CA
714-830-2003
Fax: 714-830-5668

Pasek Corp.
So. Boston, MA
800-628-2822
Fax: 617-269-0547 or 800-262-0547

Patt Corp.
Lyons, IL
800-621-4418
Fax: 708-442-3907

Pimlico Key Service, Inc.
Baltimore, MD
800-638-3815
Fax: 410-367-7319

Prime-Line Products Company
San Bernardino, CA
800-255-3505
Fax: 909-880-8968

R & S Accessories Inc.
Houston, TX
800-338-3730
Fax: 409-935-2454

R.A. Graham Co., Inc.
Worcester, MA
800-333-3933
Fax: 508-755-6584

RA-Lock Company
Cedar Hill, TX
800-777-6310
Fax: 214-291-1346

Renaud Sales Canada Corp.
Richmond Hill, Ont., Canada
905-707-0090
Fax: 800-791-8130

Rininger Lock & Supply
Lemon Grove, CA
619-463-0170
Fax: 619-697-2590

Robert Skeels & Company
Compton, CA
800-734-4539
Fax: 310-639-7569

Rudy's
Cleveland, OH
800-248-7839
Fax: 216-641-0060

Safemasters Company, Inc.
Wilmington, DE
302-478-5204

Safemasters Company, Inc.
Chicago, IL
312-627-1440

Safemasters Company, Inc.
Des Plaines, IL
708-299-

Safemasters Company, Inc.
Boston, MA
617-423-4846

DISTRIBUTORS by PRODUCT

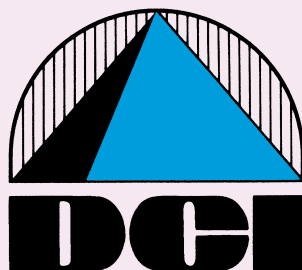

***We have it all.
Quality, Value,
& Service.***

[Click here for more information](#)

Safemasters Company, Inc.
Baltimore, MD
410-624-3300

Safemasters Company, Inc.
Silver Spring, MD
301-608-9000

Safemasters Company, Inc.
Silver Spring, MD
800-633-9977
Fax: 800-233-2454

Safemasters Company, Inc.
Barrington, NJ
609-547-4706

Safemasters Company, Inc.
Philadelphia, PA
215-561-6464

Safemasters Company, Inc.
Pittsburgh, PA
412-821-5166

Safemasters Company, Inc.
Alexandria, VA
703-354-8700

Safemasters Company, Inc.
Chesapeake, VA
804-420-0404

Safemasters Company, Inc.
Norfolk, VA
804-627-1485

Secure Industries, Inc.
Hicksville, NY
800-999-2534
Fax: 516-433-8804

Security House Padlock Distributors
Concord, Ont., Canada
800-567-5300 "Canada wide"
Fax: 905-660-6313

Security Lock Distributors
Needham Heights, MA
800-847-5625
Fax: 800-878-6400

Security Plus
Phoenix, AZ
800-426-0200
Fax: 602-234-3882

Sentinel Wholesale Hdwe. Sen. Div.
Ind.
E. Farmingdale, NY
800-526-9000
Fax: 516-753-6004

Sentry Security Fasteners, Inc.
Peoria, IL
309-693-2800
Fax: 309-693-2872

Septon Inc.
Maiden-On-The-Hudson, NY
800-537-8752
Fax: 914-246-3416

Serrubec Inc.
Montreal, Dorval, Canada
800-361-0243
Fax: 514-631-0494

Shield Supply & Services Ltd.
Winnipeg, Man., Canada
204-774-1921
Fax: 204-774-5627

Silver Sales
Plano, TX
800-258-5625
Fax: 214-618-1897

So-Cal
National City, CA
800-521-3551
Fax: 619-474-2440

Southern Lock & Supply Co.
Pinellas Park, FL
800-282-2837
Fax: 800-447-2299

Southern Lock and Supply Co.
Miami, FL
305-885-5779
Fax: 305-885-8798

Southern Lock and Supply Co.
Oakland Park, FL
305-568-9669
Fax: 305-568-3397

Southern Lock and Supply Co.
Atlanta, GA
404-455-9233
Fax: 404-455-3969

Southern Lock and Supply Co.
Charlotte, NC
704-527-6777
Fax: 704-527-0058

Space Age Locksmith Supplies, Inc.
Deland, FL
800-247-7942
Fax: 904-734-0559

Standard Wholesale Hardware Inc.
New York, NY
800-543-5625
Fax: 212-420-9892

Stears Locksmith Supply co.
Sag Harbor, NY
516-725-3273 or 516-725-8151
Fax: 516-725-7483

Stone & Berg Wholesale Locksmith
Supply
Worcester, MA
800-225-7405
Fax: 800-535-5625

Strauss Safe & Lock Co., Inc.
Des Moines, IA
800-532-4107
Fax: 515-288-9752

Taylor Security & Lock Co., Inc.
Gaithersburg, MD
800-676-7670
Fax: 301-948-1029

The Locksmith Store, Inc.
Arlington Heights, IL
708-364-5111
Fax: 708-364-5125

Timemasters
Topeka, KS
913-232-8705
Fax: 800-798-TIME

Top Notch Distributors
Honesdale, PA
800-233-4210
Fax: 800-854-4146

TRAM International Inc.
Delray Beach, FL
800-843-2440
Fax: 800-448-8280

Trans-Atlantic Company
Philadelphia, PA
800-523-9956
Fax: 215-629-1282

Transwest Hardware Sales
Vancouver, B.C., Canada
800-567-1177
Fax: 604-253-5344

Tweeds Security Hardware
Wholesalers
Portsmouth, VA
800-544-4482
Fax: 804-399-1636



SRI and Steve Young are working together to bring you the best in locksmith tools and supplies.

[Click here for more information](#)

Locking Products continued

Wadsworth White Inc.
Atlanta, GA
800-458-9449
Fax: 404-458-2253

Waldron's Security
Denver, CO
800-255-0701
Fax: 303-934-3452

Wholesale 4 Inc.
Portland, OR
800-547-0921
Fax: 503-235-5636

Wilco Supply
Oakland, CA
800-745-5450
Fax: 510-653-5397

Zipf Lock Co.
Columbus, OH
800-848-1577
Fax: 800-228-6320

Locksmith Tools

A.T. Jones & Son
Detroit, MI
800-735-4570
Fax: 313-965-1093

Access Safe & Supply Ltd.
Burlington, Ont., Canada
800-268-9033
Fax: 905-319-0366

Accredited Lock Supply Co.
Secaucus, NJ
800-652-2835
Fax: 201-865-5031

Ace Lock & Security Supply
Union, NJ
800-223-5625
Fax: 908-688-2442

Acme Wholesale Dist. - See IDN

Agences W. Pelletier (1980) Inc.
Montreal, Quebec, Canada
800-363-6700
Fax: 514-276-9413

Allied Locksmith Supply
Youngstown, OH
800-544-2102
Fax: 216-726-0865

American Access Supply
Seattle, WA
800-559-9634
Fax: 800-243-3049

American Lock & Supply
Boston, MA
800-291-2797
Fax: 800-291-2798

American Lock & Supply, Inc.
Phoenix, AZ
800-826-6968
Fax: 602-254-0272, 800-325-3728

American Lock & Supply, Inc.
Anaheim, CA
800-854-8775
Fax: 714-579-7554

American Lock & Supply, Inc.
Fremont, CA
800-227-1142
Fax: 510-651-2350, 800-662-4399

American Lock & Supply, Inc.
San Diego, CA
800-231-8435
Fax: 800-788-0916

American Lock & Supply, Inc.
Denver, CO
800-346-5549
Fax: 303-733-0202, 800-241-0202

American Lock & Supply, Inc.
Atlanta, GA
800-952-4452
Fax: 404-458-0899, 800-358-4561

American Lock & Supply, Inc.
Elmhurst, IL
800-621-0177
Fax: 708-832-9084, 800-238-5397

American Lock & Supply, Inc.
Kansas City, KS
800-888-5625
Fax: 913-432-1342, 800-395-7945

American Lock & Supply, Inc.
Elkridge, MD
800-358-6398
Fax: 410-379-5990, 800-358-6399

American Lock & Supply, Inc.
Hauppauge, NY
800-628-5625
Fax: 516-231-2019, 800-424-7185

American Lock & Supply, Inc.
Dallas, TX
800-292-0115
Fax: 214-358-6037, 800-527-3028

American Lock & Supply, Inc.
Houston, TX
800-435-8105
Fax: 713-681-0850, 800-435-8232

American Lock & Supply, Inc.
Seattle, WA
800-356-5661
Fax: 206-431-8527, 800-392-1132

AmoraTech, Inc.
Shermans Dale, PA
717-582-8114
Fax: 717-582-7549

Amos Lock & Key Supply Co.
Fort Worth, TX
800-772-7432
Fax: 317-335-5399

Anderson Lock Co.
Des Plaines, IL
708-296-1157
Fax: 708-296-9259

Apex Security Hardware Corp.
Brooklyn, NY
800-232-1117
Fax: 718-438-3327, 800-951-7000

Aristo Sales Co., Inc.
Long Island City, NY
800-221-1322
Fax: 718-937-5794

Armstrong's Lock & Supply Inc. - See IDN

Associated Lock & Supply
Port Coquitlam, BC, Canada
800-373-5754
Fax: 604-942-3761

Avco Key Supply
Northport, NY
800-332-5397
Fax: 800-329-5397

Bell's Security Sales
Bloomfield, NJ
800-772-2266
Fax: 201-743-6357

Blaydes Lock Co., Inc.
Washington, DC
800-424-2650
Fax: 202-832-1359

Blue Dog
Altamonte Springs, FL
800-248-2887
Fax: 407-774-6054

Boston Lock & Safe Co., Inc.
Brighton, MA
800-252-5757
Fax: 617-787-3425

NATIONAL
AUTO LOCK SERVICE, INC.

National Auto Lock Service, Inc. offers a wide range of equipment and services for the Automotive Locksmith. From tools and hard to find key blanks to transponder programming, we can take the mystery out of car service. We accept credit card orders, and can ship COD. Contact us for the latest in automotive technology.

Brook's Lock & Key, Inc.
Decatur, AL
800-292-5008
Fax: 205-353-8260

Brooks Supply, Inc.
Oklahoma City, OK
800-347-4477
Fax: 405-672-7575

Buffalo Safe & Lock
W. Seneca, NY
800-255-6257
Fax: 716-674-4645

Canada Lock Products - See IDN

Caola & Co.
Trenton, NJ
800-257-9469
Fax: 609-588-5247

Capitol Lock Co., Inc.
College Park, MD
301-513-9500
Fax: 301-513-9505

City Lock Supply
Boulder, CO
303-444-4407
Fax: 303-442-8380

Clark Security Products
Phoenix, AZ
800-775-5625
Fax: 602-275-9235

Clark Security Products
Bell, CA
800-889-5625
Fax: 213-262-0741

Clark Security Products
San Diego, CA
800-854-2088
Fax: 619-565-4605

Clark Security Products
San Diego, CA
800-854-2088
Fax: 619-565-4605

Clark Security Products
W. Sacramento, CA
800-245-3003
Fax: 916-372-7221

Clark Security Products
Denver, CO
800-282-5625
Fax: 800-699-3329

Clark Security Products
Wood Dale, IL
800-755-5625
Fax: 708-350-8535

Clark Security Products
Auburn, MA
800-746-5625
Fax: 800-596-5625

Clark Security Products
Lanham, MD
800-578-5625
Fax: 800-378-5625

Clark Security Products
Salt Lake City, UT
800-453-6430
Fax: 801-487-3254

Clark Security Products
Seattle, WA
800-942-5275
Fax: 800-546-5625

Colonial Lock Supply Co., Inc.
Newington, VA
800-732-9117
Fax: 703-550-8857

Commonwealth Lock Co.
Cambridge, MA
800-442-7009
Fax: 617-661-3168

Cook's Building Specialties, Inc.
Albuquerque, NM
505-883-5701
Fax: 505-883-5704

Craftmaster Hardware Co., Inc.
Hackensack, NJ
800-221-3212
Fax: 201-646-0181

Curtis Industries Inc.
Eastlake, OH
800-555-5397

DIMark International
Santa Maria, CA
800-235-2435
Fax: 805-928-8034

Doyle Lock Supply, Inc.
Minneapolis, MN
800-333-6953
Fax: 612-521-0166

Dugmore and Duncan of California
Riverside, CA
800-325-1595
Fax: 909-360-0572

Dugmore and Duncan of Florida
Lakeland, FL
800-232-1595
Fax: 813-666-5226

Dugmore and Duncan, Inc.
Hingham, MA
800-225-1595
Fax: 617-740-4043

E.L. Reinhardt
Vadnais Heights, MN
800-328-1311
Fax: 612-481-0166

Edw. Saucedo & Son Co., Inc.
El Paso, TX
800-248-3726
Fax: 915-566-8608

Enixus Trade, Ltd.
St. Catharines, Ont., Canada
905-682-3086
Fax: 905-682-3086

Ewert Wholesale Hardware Inc.
Alsip, IL
800-451-0200
Fax: 708-597-0881

Fairway Supply, Inc.
Houston, TX
800-767-3247
Fax: 713-957-2122

Foley Belsaw Co., Locksmith Division
Kansas City, MO
800-821-3452
Fax: 816-483-5010

Fortress Safe & Lock
Cincinnati, OH
800-562-0295
Fax: 513-772-5276

Fradon Lock Co., Inc.
Syracuse, NY
800-447-0591
Fax: 315-472-0958

Fried Bros. Inc.
Philadelphia, PA
800-523-2924
Fax: 215-592-1255

Gil-Ray Tools, Inc.
Bay City, MI
517-892-6870
Fax: 517-892-6870

Grace's Wholesale & Supply Div.
Hastings, NE
402-462-2737

H. Hoffman Co. - See IDN

H.E. Mitchell Co.
Portland, OR
800-626-5625
Fax: 503-238-5715



**The Innovation You Expect, with the
Flexibility You Need!**

[Click here for more information](#)

Locksmith Tools continued

H.S. & S. Wholesale Dist. of Lock Hdwe.
Detroit, MI
800-342-2202
Fax: 313-342-7580

Hans Johnsen Co.
Dallas, TX
800-678-1560
Fax: 879-1530 or 800-967-4250

Hardware Agencies Ltd.
Toronto, Ont., Canada
800-268-6741
Fax: 416-462-1922

Hardware Sales & Supply
Livonia, MI
800-521-0955
Fax: 313-591-7289

Herbert Flake Co.
Houston, TX
800-231-4105
Fax: 713-926-3399

HMC, Int'l Div., Inc.
Littleton, CO
800-848-4912 ext. 4452
Fax: 303-794-3703

Howard Sales Co.
El Paso, TX
800-456-4625
Fax: 915-833-7770

IDN - Acme, Inc.
Phoenix, AZ
800-525-3131
Fax: 602-241-0249

IDN - Acme, Inc.
Denver, CO
800-445-4008
Fax: 303-292-4369

IDN - Acme, Inc.
New Orleans, LA
800-788-2263
Fax: 504-837-7321

IDN - Acme, Inc.
Oklahoma City, OK
405-942-8750
Fax: 405-942-0523

IDN - Acme, Inc.
Fort Worth, TX
800-859-2263
Fax: 817-284-3501

IDN - Acme, Inc.
Houston, TX
800-359-2263
Fax: 713-668-8050

IDN - Acme, Inc.
214-664-1240
Fax: 214-664-1252

IDN - Acme, Inc.
San Antonio, TX
210-545-3396
Fax: 210-545-2198

IDN - Armstrong's, Inc.
Jacksonville, FL
800-341-7857
Fax: 904-387-4568

IDN - Armstrong's, Inc.
N. Miami Beach, FL
800-827-3332
Fax: 305-652-1709

IDN - Armstrong's, Inc.
Orlando, FL
800-775-1220
Fax: 407-297-9522

IDN - Armstrong's, Inc.
Tampa, FL
800-829-3332
Fax: 813-886-5696

IDN - Armstrong's, Inc.
Atlanta, GA
800-726-3332
Fax: 404-888-0834

IDN - Armstrong's, Inc.
Norfolk, VA
800-735-3334
Fax: 804-853-1832

IDN - Canada
Calgary, Alberta, Canada
800-813-5344
Fax: 403-291-4893

IDN - Canada
Edmonton, Alberta, Canada
403-944-0014
Fax: 403-944-0929

IDN - Canada
Ottawa, Ontario, Canada
613-749-2172
Fax: 613-749-6651

IDN - Canada
Toronto, Ontario, Canada
800-268-1306
Fax: 416-248-9945

IDN - H. Hoffman, Inc.
Davenport, IA
800-391-4633
Fax: 319-391-7949

IDN - H. Hoffman, Inc.
Chicago, IL
800-323-1918
Fax: 708-456-0878

IDN - H. Hoffman, Inc.
Indianapolis, IN
800-382-9449
Fax: 317-637-2358

IDN - H. Hoffman, Inc.
Overland Park, KS
800-526-5897
Fax: 913-599-4160

IDN - H. Hoffman, Inc.
St. Louis, MO
800-392-1303
Fax: 314-426-6389

IDN - H. Hoffman, Inc.
Cincinnati, OH
800-457-3963
Fax: 513-271-8567

IDN - H. Hoffman, Inc.
Valley View, OH
800-247-8217
Fax: 216-642-3901

IDN - H. Hoffman, Inc.
Menomonee Falls, WI
800-472-9191
Fax: 414-252-4378

IDN - Hardware Sales, Inc.
Ferndale, MI
800-468-7490
Fax: 313-545-0627

IDN - Hardware Sales, Inc.
Grand Rapids, MI
800-244-2444
Fax: 616-534-1904

IDN - Hardware Sales, Inc.
Livonia, MI
800-521-0955
Fax: 313-591-7289

IDN - Hardware Sales, Inc.
Pittsburgh, PA
800-837-5625
Fax: 412-771-6350

IDN - M. Taylor, Inc.
Philidelphia, PA
800-233-3355
Fax: 215-288-2511

Independent Hardware Inc.
Philadelphia, PA
800-346-9464
Fax: 215-922-6552

Intermountain Lock & Supply
Denver, CO
800-323-8046
Fax: 303-698-2094

Island Pacific Distributors, Inc.
Honolulu, HI
808-955-1126
Fax: 808-946-6480

J & J Distributors
San Antonio, TX
210-734-6165
Fax: 210-735-2248

J & M Distributing
Chicago, IL
800-645-0040
Fax: 312-583-0040

J. Nathan Hardware Specialties Inc.
Rochester, NY
800-634-2580
Fax: 716-325-7196

Jack Stearman Ltd.
Vancouver, B.C., Canada
604-872-8415
Fax: 604-875-9174

Jim Ripley's Services, Inc.
Claremore, OK
918-341-1077

Jo-Van Distributors
Scarborough, Ont., Canada
800-268-5731
Fax: 800-286-5010

K & K Supply, Inc.
Upland, CA
800-233-7772
Fax: 909-920-0402

Kenco Supply Co.
Omaha, NE
800-228-2266
Fax: 800-228-4175

Key Hardware Company
Los Angeles, CA
213-255-9873
Fax: 213-255-8457

Key Sales & Supply Co.
Detroit, MI
800-445-KEYS (5397)
Fax: 313-931-7758

Keys Plus Distributing
Tonawanda, NY
716-743-0220

Keys Wholesale Distributors
Drexel Hill, PA
800-292-5397
Fax: 610-626-4189

Kramer Boys Locksmith Supply
Trenton, NJ
800-222-2692
Fax: 609-586-0512

LDM Enterprises, Inc.
Westlake Village, CA
800-451-5950
Fax: 818-706-8560

Lock Wise Security Products
Miami, FL
800-447-6616
Fax: 305-623-9564

Lockmasters Inc.
Nicolasville, KY
800-654-0637
Fax: 606-885-7093

Locks Co.
N. Miami, FL
800-288-0801
Fax: 305-949-3619

M. Shepse Co. Div. American Bionics
Pittsburgh, PA
800-666-6007
Fax: 412-381-5122

M. Taylor Inc. - See IDN
Major Lock Supply
Fullerton, CA
714-447-8363
Fax: 714-447-8393

Mark Bates Associates
Nicholasville, KY
800-555-4471
Fax: 606-858-4292

Mayflower Sales Co., Inc.
Brooklyn, NY
800-224-2052
Fax: 718-789-8346

Maziuk & Co., Inc.
Syracuse, NY
800-777-5945
Fax: 315-472-3111

McDonald Dash Locksmith Supply, Inc.
Memphis, TN
800-238-7541
Fax: 901-366-0005

McManus Locksmith Supply, Inc.
Charlotte, NC
800-432-6342, SC 800-438-6567
Fax: 704-332-8664

Mid-South Locksmith Supply
Memphis, TN
800-238-6166
Fax: 901-795-3475

New York Locksmith Supply Co., Inc.
New York, NY
212-737-0178, 914-328-1919
Fax: 212-988-9192

Northwest Lock & Supply Co.
Albany, OR
800-359-9425
Fax: 503-928-9338

Orchard Lock Distributors, Inc.
Hamden, CT
800-233-2146
Fax: 203-624-4083

Panef
Milwaukee, WI
800-448-1247
Fax: 414-462-0980

Pasek Corp.
So. Boston, MA
800-628-2822
Fax: 617-269-0547 or 800-262-0547

Pimlico Key Service, Inc.
Baltimore, MD
800-638-3815
Fax: 410-367-7319

Rininger Lock & Supply
Lemon Grove, CA
619-463-0170
Fax: 619-697-2590

Robert Skeels & Company
Compton, CA
800-734-4539
Fax: 310-639-7569

Secure Industries, Inc.
Hicksville, NY
800-999-2534
Fax: 516-433-8804

Security Lock Distributors
Needham Heights, MA
800-847-5625
Fax: 800-878-6400

Security Plus
Phoenix, AZ
800-426-0200
Fax: 602-234-3882

Sentinel Wholesale Hdwe. Sen. Div. Ind.
E. Farmingdale, NY
800-526-9000
Fax: 516-753-6004

Sentry Security Fasteners, Inc.
Peoria, IL
309-693-2800
Fax: 309-693-2872

Continued on page 64

**Locksmith Tools
Continued from page 62**

Septon Inc.
Maiden-On-The-Hudson, NY
800-537-8752
Fax: 914-246-3416

Serrubec Inc.
Montreal, Dorval, Canada
800-361-0243
Fax: 514-631-0494

Shield Supply & Services Ltd.
Winnipeg, Man., Canada
204-774-1921
Fax: 204-774-5627

Slide Lock Tool Co.
Louisville, TN
800-336-8812
Fax: 615-577-5936

So-Cal
National City, CA
800-521-3551
Fax: 619-474-2440

Southern Lock & Supply Co.
Pinellas Park, FL
800-282-2837
Fax: 800-447-2299

Southern Lock and Supply Co.
Miami, FL
305-885-5779
Fax: 305-885-8798

Southern Lock and Supply Co.
Oakland Park, FL
305-568-9669
Fax: 305-568-3397

Southern Lock and Supply Co.
Atlanta, GA
404-455-9233
Fax: 404-455-3969

Southern Lock and Supply Co.
Charlotte, NC
704-527-6777
Fax: 704-527-0058

Standard Wholesale Hardware Inc.
New York, NY
800-543-5625
Fax: 212-420-9892

Stears Locksmith Supply co.
Sag Harbor, NY
516-725-3273 or 516-725-8151
Fax: 516-725-7483

Stone & Berg Wholesale Locksmith
Supply
Worcester, MA
800-225-7405
Fax: 800-535-5625

Strauss Safe & Lock Co., Inc.
Des Moines, IA
800-532-4107
Fax: 515-288-9752

Taylor Security & Lock Co., Inc.
Gaithersburg, MD
800-676-7670
Fax: 301-948-1029

The Locksmith Store, Inc.
Arlington Heights, IL
708-364-5111
Fax: 708-364-5125

The Power Company
Seattle, WA
206-624-5090
Fax: 206-624-5214

Timemasters
Topeka, KS
913-232-8705
Fax: 800-798-TIME

Transwest Hardware Sales
Vancouver, B.C., Canada
800-567-1177
Fax: 604-253-5344

Tweed's Security Hardware
Wholesalers
Portsmouth, VA
800-544-4482
Fax: 804-399-1636

Waldron's Security
Denver, CO
800-255-0701
Fax: 303-934-3452

Wedge Co Tool Supply International
Bellevue, WA
800-452-2304

Wholesale 4 Inc.
Portland, OR
800-547-0921
Fax: 503-235-5636

Wilco Supply
Oakland, CA
800-745-5450
Fax: 510-653-5397

Zipf Lock Co.
Columbus, OH
800-848-1577
Fax: 800-228-6320

Safes

Access Safe & Supply Ltd.
Burlington, Ont., Canada
800-268-9033
Fax: 905-319-0366

Accredited Lock Supply Co.
Secaucus, NJ
800-652-2835
Fax: 201-865-5031

Ace Lock & Security Supply
Union, NJ
800-223-5625
Fax: 908-688-2442

Acme Wholesale Dist. - See IDN

Adams Lock & Safe Co., Inc.
Concord, NH
800-635-2228
Fax: 603-226-4983

Agences W. Pelletier (1980) Inc.
Montreal, Quebec, Canada
800-363-6700
Fax: 514-276-9413

Ambassador Wholesale Safe
Distributors
Lake Hiawatha, NJ
800-999-5510
Fax: 201-402-1447

American Lock & Key Co.
Richmond, VA
800-995-6247
Fax: 804-282-1007

American Lock & Supply
Boston, MA
800-291-2797
Fax: 800-291-2798

American Lock & Supply, Inc.
Phoenix, AZ
800-826-6968
Fax: 602-254-0272, 800-325-3728

American Lock & Supply, Inc.
Anaheim, CA
800-854-8775
Fax: 714-579-7554

American Lock & Supply, Inc.
Fremont, CA
800-227-1142
Fax: 510-651-2350, 800-662-4399

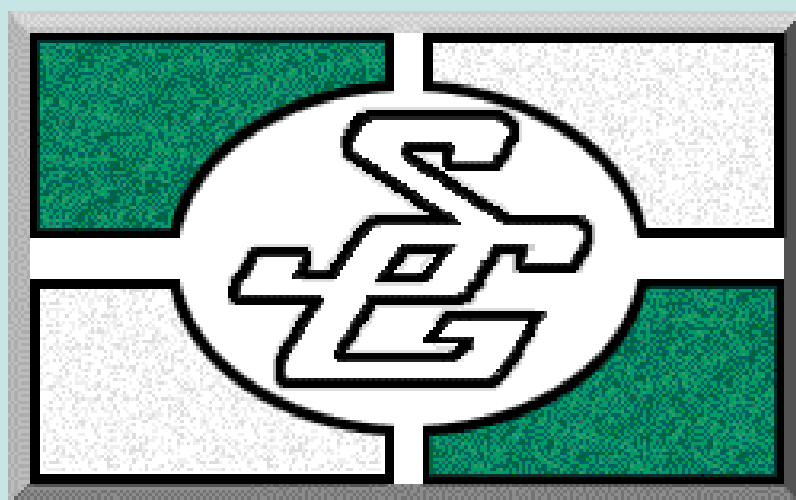

*Make Sargent & Greenleaf's
Comptronic locks your choice for
electronic safe locking solutions.*

[Click here for more information](#)

American Lock & Supply, Inc.
San Diego, CA
800-231-8435
Fax: 800-788-0916

American Lock & Supply, Inc.
Denver, CO
800-346-5549
Fax: 303-733-0202, 800-241-0202

American Lock & Supply, Inc.
Atlanta, GA
800-952-4452
Fax: 404-458-0899, 800-358-4561

American Lock & Supply, Inc.
Elmhurst, IL
800-621-0177
Fax: 708-832-9084, 800-238-5397

American Lock & Supply, Inc.
Kansas City, KS
800-888-5625
Fax: 913-432-1342, 800-395-7945

American Lock & Supply, Inc.
Elkridge, MD
800-358-6398
Fax: 410-379-5990, 800-358-6399

American Lock & Supply, Inc.
Hauppauge, NY
800-628-5625
Fax: 516-231-2019, 800-424-7185

American Lock & Supply, Inc.
Dallas, TX
800-292-0115
Fax: 214-358-6037, 800-527-3028

American Lock & Supply, Inc.
Houston, TX
800-435-8105
Fax: 713-681-0850, 800-435-8232

American Lock & Supply, Inc.
Seattle, WA
800-356-5661
Fax: 206-431-8527, 800-392-1132

Anchor Safe Co.
Warren, MI
800-541-8050
Fax: 810-755-1760

Armstrong's Lock & Supply Inc. - See IDN

Associated Lock & Supply
Port Coquitlam, BC, Canada
800-373-5754
Fax: 604-942-3761

Boston Lock & Safe Co., Inc.
Brighton, MA
800-252-5757
Fax: 617-787-3425

Brook's Lock & Key, Inc.
Decatur, AL
800-292-5008
Fax: 205-353-8260

Brooks Supply, Inc.
Oklahoma City, OK
800-347-4477
Fax: 405-672-7575

Buffalo Safe & Lock
W. Seneca, NY
800-255-6257
Fax: 716-674-4645

Canada Lock Products - See IDN

Clark Security Products
Phoenix, AZ
800-775-5625
Fax: 602-275-9235

Clark Security Products
Bell, CA
800-889-5625
Fax: 213-262-0741

Clark Security Products
San Diego, CA
800-854-2088
Fax: 619-565-4605

Clark Security Products
San Diego, CA
800-854-2088
Fax: 619-565-4605

Clark Security Products
W. Sacramento, CA
800-245-3003
Fax: 916-372-7221

Clark Security Products
Denver, CO
800-282-5625
Fax: 800-699-3329

Clark Security Products
Wood Dale, IL
800-755-5625
Fax: 708-350-8535

Clark Security Products
Auburn, MA
800-746-5625
Fax: 800-596-5625

Clark Security Products
Lanham, MD
800-578-5625
Fax: 800-378-5625

Clark Security Products
Salt Lake City, UT
800-453-6430
Fax: 801-487-3254

Clark Security Products
Seattle, WA
800-942-5275
Fax: 800-546-5625

Colonial Lock Supply Co., Inc.
Newington, VA
800-732-9117
Fax: 703-550-8857

Commonwealth Lock Co.
Cambridge, MA
800-442-7009
Fax: 617-661-3168

Defiant Safe Co.
Dallas, TX
800-225-2984
Fax: 214-241-7669

Doyle Lock Supply, Inc.
Minneapolis, MN
800-333-6953
Fax: 612-521-0166

E.L. Reinhardt
Vadnais Heights, MN
800-328-1311
Fax: 612-481-0166

Edw. Saucedo & Son Co., Inc.
El Paso, TX
800-248-3726
Fax: 915-566-8608

Empire Security Supplies
Pt. Jefferson Station, NY
516-928-1919
Fax: 516-928-4745

Ewert Wholesale Hardware Inc.
Alsip, IL
800-451-0200
Fax: 708-597-0881

Fairway Supply, Inc.
Houston, TX
800-767-3247
Fax: 713-957-2122

Fradon Lock Co., Inc.
Syracuse, NY
800-447-0591
Fax: 315-472-0958

Fried Bros. Inc.
Philadelphia, PA
800-523-2924
Fax: 215-592-1255



SCHWAB CORP.

Fire protection for your vital records.

***It's not safe unless
it's Schwab Safe.***

[Click here for more information](#)

**Lockmasters has a
44 year history of
training security
professionals.**

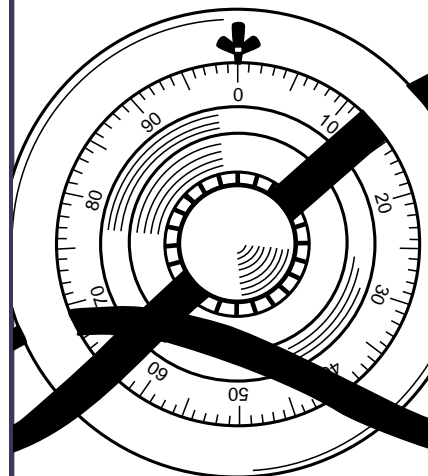

[Click here for more information](#)

Safes continued

Grace's Wholesale & Supply Div.
Hastings, NE
402-462-2737

Great Lakes Lock Distributors
Erie, PA
800-543-8837
Fax: 814-456-1542

H. Hoffman Co. - See IDN

H.E. Mitchell Co.
Portland, OR
800-626-5625
Fax: 503-238-5715

H.S. & S. Wholesale Dist. of Lock
Hdwe.
Detroit, MI
800-342-2202
Fax: 313-342-7580

Hans Johnsen Co.
Dallas, TX
800-678-1560
Fax: 879-1530 or 800-967-4250

Hardware Agencies Ltd.
Toronto, Ont., Canada
800-268-6741
Fax: 416-462-1922

Hardware Sales & Supply - See IDN

Herbert Flake Co.
Houston, TX
800-231-4105
Fax: 713-926-3399

IDN - Acme, Inc.
Phoenix, AZ
800-525-3131
Fax: 602-241-0249

IDN - Acme, Inc.
Denver, CO
800-445-4008
Fax: 303-292-4369

IDN - Acme, Inc.
New Orleans, LA
800-788-2263
Fax: 504-837-7321

IDN - Acme, Inc.
Oklahoma City, OK
405-942-8750
Fax: 405-942-0523

IDN - Acme, Inc.
Fort Worth, TX
800-859-2263
Fax: 817-284-3501

IDN - Acme, Inc.
Houston, TX
800-359-2263
Fax: 713-668-8050

IDN - Acme, Inc.
Richardson, TX
214-664-1240
Fax: 214-664-1252

IDN - Acme, Inc.
San Antonio, TX
210-545-3396
Fax: 210-545-2198

IDN - Armstrong's, Inc.
Jacksonville, FL
800-341-7857
Fax: 904-387-4568

IDN - Armstrong's, Inc.
N. Miami Beach, FL
800-827-3332
Fax: 305-652-1709

IDN - Armstrong's, Inc.
Orlando, FL
800-775-1220
Fax: 407-297-9522

IDN - Armstrong's, Inc.
Tampa, FL
800-829-3332
Fax: 813-886-5696

IDN - Armstrong's, Inc.
Atlanta, GA
800-726-3332
Fax: 404-888-0834

IDN - Armstrong's, Inc.
Norfolk, VA
800-735-3334
Fax: 804-853-1832

IDN - Canada
Calgary, Alberta, Canada
800-813-5344
Fax: 403-291-4893

IDN - Canada
Edmonton, Alberta, Canada
403-944-0014
Fax: 403-944-0929

IDN - Canada
Ottawa, Ontario, Canada
613-749-2172
Fax: 613-749-6651

IDN - Canada
Toronto, Ontario, Canada
800-268-1306
Fax: 416-248-9945

IDN - H. Hoffman, Inc.
Davenport, IA
800-391-4633
Fax: 319-391-7949

IDN - H. Hoffman, Inc.
Chicago, IL
800-323-1918
Fax: 708-456-0878

IDN - H. Hoffman, Inc.
Indianapolis, IN
800-382-9449
Fax: 317-637-2358

IDN - H. Hoffman, Inc.
Overland Park, KS
800-526-5897
Fax: 913-599-4160

IDN - H. Hoffman, Inc.
St. Louis, MO
800-392-1303
Fax: 314-426-6389

IDN - H. Hoffman, Inc.
Cincinnati, OH
800-457-3963
Fax: 513-271-8567

IDN - H. Hoffman, Inc.
Valley View, OH
800-247-8217
Fax: 216-642-3901

IDN - H. Hoffman, Inc.
Menomonee Falls, WI
800-472-9191
Fax: 414-252-4378

IDN - Hardware Sales, Inc.
Ferndale, MI
800-468-7490
Fax: 313-545-0627

IDN - Hardware Sales, Inc.
Grand Rapids, MI
800-244-2444
Fax: 616-534-1904

IDN - Hardware Sales, Inc.
Livonia, MI
800-521-0955
Fax: 313-591-7289

IDN - Hardware Sales, Inc.
Pittsburgh, PA
800-837-5625
Fax: 412-771-6350

IDN - M. Taylor, Inc.
Philadelphia, PA
800-233-3355
Fax: 215-288-2511

Intermountain Lock & Supply
Denver, CO
800-323-8046
Fax: 303-698-2094

Island Pacific Distributors, Inc.
Honolulu, HI
808-955-1126
Fax: 808-946-6480

Jack Slearman Ltd.
Vancouver, B.C., Canada
604-872-8415
Fax: 604-875-9174

K & K Supply, Inc.
Upland, CA
800-233-7772
Fax: 909-920-0402

Kenco Supply Co.
Omaha, NE
800-228-2266
Fax: 800-228-4175

Key Hardware Company
Los Angeles, CA
213-255-9873
Fax: 213-255-8457

Key Mart Inc.
Stuart, FL
800-228-7755
Fax: 407-220-7920

Key Sales & Supply Co.
Detroit, MI
800-445-KEYS (5397)
Fax: 313-931-7758

Keystone Safe Distributors
Huntingdon Valley, PA
800-755-2893
Fax: 215-627-6419

Kramer Boys Locksmith Supply
Trenton, NJ
800-222-2692
Fax: 609-586-0512

Lock Wise Security Products
Miami, FL
800-447-6616
Fax: 305-623-9564

Locks Co.
N. Miami, FL
800-288-0801
Fax: 305-949-3619

M. Shepse Co. Div. American Bionics
Pittsburgh, PA
800-666-6007
Fax: 412-381-5122

M. Taylor Inc. - See IDN

Major Lock Supply
Fullerton, CA
714-447-8363
Fax: 714-447-8393

Mancini Safe Company
Cambridge, MA
800-367-3453
Fax: 617-497-7542

Mayflower Sales Co., Inc.
Brooklyn, NY
800-224-2052
Fax: 718-789-8346

Maziuk & Co., Inc.
Syracuse, NY
800-777-5945
Fax: 315-472-3111

McDonald Dash Locksmith Supply, Inc.
Memphis, TN
800-238-7541
Fax: 901-366-0005

McManus Locksmith Supply, Inc.
Charlotte, NC
NC 800-432-6342, SC 800-438-6567
Fax: 704-332-8664

Metro Safe Co., Inc.
Madison Heights, MI
800-541-8050
Fax: 810-755-1760

Mid-South Locksmith Supply
Memphis, TN
800-238-6166
Fax: 901-795-3475

Midwest Safe Distributors
Philadelphia, PA
800-713-7233
Fax: 800-355-1195

Northwest Lock & Supply Co.
Albany, OR
800-359-9425
Fax: 503-928-9338

Orchard Lock Distributors, Inc.
Hamden, CT
800-233-2146
Fax: 203-624-4083

Rininger Lock & Supply
Lemon Grove, CA
619-463-0170
Fax: 619-697-2590

Robert Skeels & Company
Compton, CA
800-734-4539
Fax: 310-639-7569

S & J Products & Services
Yakima, WA
800-735-1797
Fax: 509-575-1875

Safemasters Company, Inc.
Wilmington, DE
302-478-5204

Safemasters Company, Inc.
Chicago, IL
312-627-1440

Safemasters Company, Inc.
Des Plaines, IL
708-299-3420

Safemasters Company, Inc.
Boston, MA
617-423-4846

Safemasters Company, Inc.
Baltimore, MD
410-624-3300

Safemasters Company, Inc.
Silver Spring, MD
301-608-9000

Safemasters Company, Inc.
Silver Spring, MD
800-633-9977
Fax: 800-233-2454

Safemasters Company, Inc.
Barrington, NJ
609-547-4706

Safemasters Company, Inc.
Philadelphia, PA
215-561-6464

Safemasters Company, Inc.
Pittsburgh, PA
412-821-5166

Safemasters Company, Inc.
Alexandria, VA
703-354-8700

Safemasters Company, Inc.
Chesapeake, VA
804-420-0404

Safemasters Company, Inc.
Norfolk, VA
804-627-1485

Security Plus
Phoenix, AZ
800-426-0200
Fax: 602-234-3882

Shield Supply & Services Ltd.
Winnipeg, Man., Canada
204-774-1921
Fax: 204-774-5627

Southern Lock & Supply Co.
Pinellas Park, FL
800-282-2837
Fax: 800-447-2299

Southern Lock and Supply Co.
Miami, FL
305-885-5779
Fax: 305-885-8798

Southern Lock and Supply Co.
Oakland Park, FL
305-568-9669
Fax: 305-568-3397

Southern Lock and Supply Co.
Atlanta, GA
404-455-9233
Fax: 404-455-3969

Southern Lock and Supply Co.
Charlotte, NC
704-527-6777
Fax: 704-527-0058

Standard Wholesale Hardware Inc.
New York, NY
800-543-5625
Fax: 212-420-9892

Stone & Berg Wholesale Locksmith
Supply
Worcester, MA
800-225-7405
Fax: 800-535-5625

Strauss Safe & Lock Co., Inc.
Des Moines, IA
800-532-4107
Fax: 515-288-9752

Taylor Security & Lock Co., Inc.
Gaithersburg, MD
800-676-7670
Fax: 301-948-1029

Timemasters
Topeka, KS
913-232-8705
Fax: 800-798-TIME

Turn 10 Wholesale
Marietta, OH
800-848-9790
Fax: 800-391-4553

Tweed's Security Hardware
Wholesalers
Portsmouth, VA
800-544-4482
Fax: 804-399-1636

Wholesale 4 Inc.
Portland, OR
800-547-0921
Fax: 503-235-5636

Wilco Supply
Oakland, CA
800-745-5450
Fax: 510-653-5397

Zipf Lock Co.
Columbus, OH
800-848-1577
Fax: 800-228-6320



HPC, Inc. Designing Excellence and Manufacturing Quality since 1956

[Click here for more information](#)

DISTRIBUTORS by PRODUCT

MANUFACTURERS

A&B Safe Corp.
2300 W. Bloomingdale Ave.
Chicago, IL 60647
800-253-1267
312-342-0068-69
Fax: 312-342-6694
Key Personnel: F. Bernath, Pres., Nellie A. Bernath
Product Categories: H

A-1 Security Mfg. Corp.
3528 Mayland Ct.
Richmond, VA 23233
804-747-0095
Fax: 804-747-0534
Key Personnel: Frank McCarthy, GM, Page McCarthy, Cust. Svc. Mgr.
Product Categories: G

A-J Mfg. Co., Inc.
3601 E. 18th St.
Kansas City, MO 64127
816-231-5522
Fax: 816-231-8437
Key Personnel: Robert Haake
See ad on page 30

A.D.D.M. International Inc.
3091 Trinity St., P.O. Box 572
Oceanside, NY 11572
516-766-5997
Fax: 516-678-0259
Key Personnel: A. Gesser, Pres., D. Gesser
Product Categories: A

Aable Locksmiths
91-10 Liberty Ave.
Ozone Park, NY 11417
718-847-1377
Fax: 718-847-0991
Key Personnel: Frank Markisello, RL Owner, Elizabeth Markisello
Product Categories: B G

Aanon/Safetron
P.O. Box 1451
Englewood, CO 80150
303-781-1413
Fax: 303-783-0087
Key Personnel: Brian Hambleton, Pres., Lorraine Hambleton, VP Sales
Product Categories: C E F H

ABC Lock Co.
RR 1, Box 12C
Council Bluffs, IA 51503
712-366-4703
Key Personnel: Don Parkins, CEO
Product Categories: G

Abco Lock & Safe
6212 S. Dixie Hwy.
Miami, FL 33143
305-667-0766
Fax: 305-667-7725
Key Personnel: Nadine Nunberg

Abloy Disklock Pro
10800 Foster Ave.
Brooklyn, NY 11236
718-927-2772
Fax: 718-257-2772
Key Personnel: Wayne Wilkerson, Pres. & CEO, Michael Crowder, Nat'l. Sales Mgr., Michael Kirkpatrick, Produ. Mgr.
Product Categories: B F

Abloy Security, Inc.
6015 Commerce, Ste. 450
Irving, TX 75063
800-367-4598
214-753-1127
Fax: 214-753-0792
Key Personnel: Charlie Armstrong, GM, Mark Imhof, Mktg. Mgr.
Product Categories: F

Abus Lock Co.
218 W. Cummings Park, P.O. Box 2367
Woburn, MA 01801
800-225-5348
617-935-8370

Fax: 617-938-7009
Key Personnel: Thomas R. Laitala, Chairman, George R. Hansen, VP Sales & Mktg. Richard Segerstedt, VP Comptroller
Product Categories: F

Access Protection Corp.
216 Plaistow Rd.
Plaistow, NH 03865
603-382-0822
Fax: 603-382-0833
Key Personnel: Marc Katz, Nat'l Sales Dir.
Product Categories: B F
See ad on page 4

Access Specialties & Products
211 Beeline Dr., No. 3
Bensenville, IL 60106
800-853-8377
708-766-5292
Fax: 708-766-2609
Key Personnel: John Woodward, Eng. Dir., Shirley Henderson, VP, Mark Allison, Sales Mgr.
Product Categories: B

Access Technology, Inc.
P.O. Box 10
Redmond, WA 98073-0010
206-556-0357
Fax: 206-558-1205
Key Personnel: Gerry Levy, National Sales, Steve Shain
Product Categories: B E F

Acclaim Images, LLC
608 2nd St.
Midlothian, TX 76065
214-296-6785
Fax: 214-296-7110
Key Personnel: Pam Albright, CEO
Product Categories: C D G

Accurate Lock & Hardware Co.
Annie Pl
Stamford, CT 06902
203-348-8865
Fax: 203-348-5234
Key Personnel: Ronald M. Salvatore, Pres.
Product Categories: B F

Active Technologies Inc.
1117 LaVelle Rd.
Alamogordo, NM 88310
800-545-5348
505-437-0021
Fax: 505-434-6149
Key Personnel: Pat Bond, Sales Mgr.
Product Categories: G

Adam Lock Company
455 N. Tustin
Orange, CA 92667
714-633-6520
Fax: 714-633-6529
Key Personnel: Joe J. Adam

Adams Rite Manufacturing Co.
4040 So. Capitol Ave.
City of Industry, CA 91749
800-872-3267
310-699-0511
Fax: 310-699-5094
Key Personnel: Dick Kreidel, VP-Bus. Dev., Dave Orban, Dir.- Bus. Dev., Larry Whipple, Mgr.- Cust. Sat. Group
Product Categories: B

Adapt-A-Bore™
318 N. Milwaukee St.
Milwaukee, WI 53202
414-291-5684
Fax: 414-291-5685
Key Personnel: Andrew S. Pokrass
Product Categories: G

Adesco Safe Mfg. Co.
16720 S. Garfield Ave.
Paramount, CA 90723
800-821-6803
310-630-1503
Fax: 714-761-2846

E Mail: adesco@aol.com
Key Personnel: Earl Halls, GM, Chuck Basso, VP Sales, Gary Cromer, Tech. Supp.
Product Categories: H

Adrian Steel Co.
906 James St.
Adrian, MI 49221
517-265-6194
Fax: 517-265-5834
Key Personnel: Karen Poe, Sales Coord.

Advance Car Mover Company
240 N. Depot St., P.O. Box 1
Juneau, WI 53039
800-571-0136 ext. 64
414-386-4464
Fax: 414-386-4416
Key Personnel: Merlin Kreger, Pres., Pat Reif, Inside Sales & Accts. Rec.
Product Categories: G

Advanced Hardware Technologies
508 Griffith Rd.
Charlotte, NC 28217
800-277-9377
704-525-9005
Fax: 704-525-7337
Key Personnel: D.W. Boyer, N.A. Millman
Product Categories: B F

Aero Lock
3675 New Getwell Rd. #9
Memphis, TN 38118
800-627-9433
901-368-2147
Key Personnel: Jim Clark, Owner, David Parrott, Owner, Monika Parrott, Owner
Product Categories: G

Aiphone Communications Systems
1700 130th Ave. NE
Bellevue, WA 98005
800-692-0200 (orders only)
206-455-0510
Fax: 206-455-0071
Key Personnel: Jan Matsarof, Pres., Clyde Phifer, Sales & Mktg. VP, Chuck Watkins, Sales Mgr.
Product Categories: E F

Alarm Lock Systems, Inc.
345 Bayview Ave.
Amityville, NY 11701
800-ALA-LOCK
516-789-4871
Fax: 516-789-3383
Key Personnel: Brian Strom, VP Sales, Ken Lange, Nat'l. Sales Mgr., Leslie Provanzano, Mgr.
Product Categories: E F
See ad on page 69

Alarm-Saf
65 A Industrial Way
Wilmington, MA 01887
508-658-6717
Fax: 508-658-8638
Key Personnel: Gordon Pendleton, VP Mktg., Joe Mondello, Eng. Sup., Barbara Hagan, Cust. Svc. Sup.
Product Categories: E

ALK Contractors Supply Corp.
1266 W. Lake St.
Roselle, IL 60172
708-894-0041
Fax: 708-894-8081
Key Personnel: Andy Maglio
Product Categories: B

All Safe & Security
2311 S. 108th St.
West Allis, WI 53227
800-310-3535
414-344-3434
Fax: 414-546-6300
Key Personnel: Tom Schmitt, Pres.
Product Categories: F G

All-Lock Co., Inc.
900 Ravenwood Dr.
Selma, AL 36701
334-874-9001
Fax: 334-874-6011
Key Personnel: Jesse Hermann, Pres., Jim Gibbard, Vice Pres. & GM, Russell Alsbrook, Nat'l Sales Mgr.
Product Categories: C F G
See ads on pages 21, 23 & 25

Allied•Gary International
P.O. Box 947 Gary Way
Waynesboro, GA 30830
800-456-4279
706-554-1918
Fax: 706-554-3319
Key Personnel: Steve Bucher, Plant Mgr., Mike Long, Mgr. Eng., James Salter, Mgr. Cust. Svc.
Product Categories: E H

Allsafe Company, Inc.
1105 Broadway
Buffalo, NY 14212
800-828-7162
716-896-4515
Fax: 716-896-4241
Key Personnel: James E. Pokornowski, Pres., Mike Davis, Dir. of Eng.
Product Categories: E

Almet Inc.
8205 Montreal-Toronto Blvd.
Montreal, Canada H4X 1N1
514-364-4211
Fax: 514-364-4912
Key Personnel: Jean-Marc Crete, Contract & Architectural Manager, Audrey Siedert, Sales Manager
Product Categories: B

Almont Lock Co., Inc.
113 School St.
Almont, MI 48003
810-798-8950
Key Personnel: David Popovici, Pres., Arcadia Popovici, CEO
Product Categories: F G
See ad on page 52

Alpina/Calibro Corporation
14911-127th St.
Lemont, IL 60439
708-257-8008
Key Personnel: Darius Augustine, GM
Product Categories: F

Alltrion Corporation
140-58th St., Bldg. A-3 West
Brooklyn, NY 11220
718-567-8181
Fax: 718-567-9056
Key Personnel: Alan Forman, VP Mktg., Jonathon Sohnia, VP Eng., Robert Scanapica, Tech. Sales Mgr.
Product Categories: E

America Key Boxes
4520 Forest Hill Cir. #13
Ft. Worth, TX 76140
800-561-5397
817-561-5397
Fax: 817-561-2881
Key Personnel: James E. Victory, Owner, Josephine Victory, Owner
Product Categories: G
See ad on page 139

Product Category Key

- A — Alarms
- B — Architectural Hardware
- C — Training Manuals & Materials
- D — Locksmith Software
- E — Electronic Security Products
- F — Locking Products
- G — Locksmith Tools & Equipment
- H — Safes & Safe Products

Continued on page 70

Continued from page 68

American Auto Accessories, Inc.
11201 Northern Blvd.
Corona, NY 11368
800-THE-1800
718-458-6200
Fax: 718-458-9110
Key Personnel: Henry Hsu, Exec. Dir.,
Ms. Betty Hsu, VP, David Yu, Mktg.
Dir., Sales Mgr.
Product Categories: A F

American Device Mfg. Co.
1003 W. Broadway, P.O. Box 8
Steeleville, IL 62288
800-637-3763
618-965-3491
Fax: 800-553-2362
Key Personnel: Paul Kosakowski, Vice
President, Sales & Marketing, Tom
Walls, National Sales Manager
Product Categories: B E

American Lock Co.
3400 W. Exchange Rd.
Crete, IL 60417
800-323-4568
708-534-2000
Fax: 708-534-0531
Key Personnel: David L. Anderson,
Nat'l. Sales Mgr., Philip E. Settecase,
VP Sales/Mktg.
Product Categories: F

American Magnetics Corporation
740 Watson Center Rd.
Callsbao, CA 92009
213-775-8651
Fax: 310-834-0685
Key Personnel: Richard Kelley, VP
Access Control, Ed Sims, Dir. Techn.
Svc.
Product Categories: E

American Metal
P.O. Box 80427
San Marino, CA 91118
818-292-1300
Fax: 818-292-FAX+
E Mail: ametal@primenet.com
Key Personnel: Mike Hernandez,
Trustee, Michael Roth, Op. Mgr.
Product Categories: E F

American Saw & Mfg. Company
301 Chestnut St.
E. Longmeadow, MA 01028
800-628-8810
413-525-3961
Fax: 413-525-8224
Key Personnel: Don Belleville, Sales
Mgr.
Product Categories: G

American Security Prod. Co.
11925 Pacific Ave.
Fontana, CA 92337
800-421-6142
909-685-9680
Fax: 909-685-9685
Key Personnel: Frank Cademartori,
Pres., Robert E. Sallee, Nat'l. Sales
Mgr., Tracy L. Russell, Reg. Sales Mgr.
Product Categories: E H
See ad on page 20

AMSECO
236 E. Star of India Ln.
Carson, CA 90746
800-421-1096
310-538-4670
Fax: 310-538-9932
Key Personnel: Yutaka Odawara,
Pres., Thomas Fessler, VP Sales &
Mktg., Sergio Galvez, Adv. Mgr.
Product Categories: A E

Anderson Lock & Security
2815 N. Comanche
Chandler, AZ 85224
602-821-2600
Key Personnel: Roger Anderson
Product Categories: G

APEX, A Division of Pittway Corp.
3510 Spring Forest Rd.
Raleigh, NC 27604
800-272-7937
919-876-0010
Fax: 919-850-0977
Key Personnel: David Hanchette, Dir.

Sales & Mktg., Thomas Moroan,
Nat'l. Rep. Thomas Balboni, Nat.
Rep.
Product Categories: A E

APR Industries, Inc.
P.O. Box 342
Boonton, NJ 07005
800-729-2674
201-316-9444
Fax: 201-335-3008
Key Personnel: Alan Paul Romanowicz,
VP, Jennifer Pearce, GM
Product Categories: A B C F
See ad on page 20

Architectural Control Systems, Inc.
10666 Gateway Blvd.
St. Louis, MO 63132
800-753-5558
314-432-5588
Fax: 314-432-2090
Key Personnel: Dave Senften, Pres.,
Tony Caponi, VP, Mark LeGrand, VP
Product Categories: E

Aritech Corp.
1510 Tate Blvd., SE
Hickory, NC 28601
Key Personnel: Jim Synk, CEO

Armor Safe Technologies
2580 Progress St.
Vista, CA 92083
800-487-2766
619-598-5470
Fax: 619-598-5471
Key Personnel: A. Steve Allison, CEO
& Div. Mgr., Dave Simons, Cust.
Supp. Mgr., Craig Fowler, Prod. Mgr.
Product Categories: H

Armstrong Security Lock Corp.
54-45 44th St.
Maspeth, NY 11378
Key Personnel: Mark Berger, Nat'l.
Sales Mgr.

Arrow Lock Mfg. Co.
10300 Foster Ave.
Brooklyn, NY 11236
800-233-0478
718-257-4700
Fax: 718-649-9097
Key Personnel: C. Thelin, Pres., Carl
Sideranko, Dir. of Sales & Mktg.,
Steven Pollack, Mktg. Mgr.
Product Categories: A B F

ASSA High Security Locks
103-00 Foster Ave.
Brooklyn, NY 11236
718-927-2772
Fax: 718-257-2772
Key Personnel: Wayne Wilkerson,
Pres., Michael Crowder, Nat'l. Sales
Mgr., Michael Kirkpatrick, Prod. Mgr.
Product Categories: B F

Audio Alert Systems
4208 Dover Rd.
Louisville, KY 40216
502-448-6699
Fax: 502-448-0018
Key Personnel: Glenn Isaacs

Auth Chimes/Authentic Parts
561 Acorn St.
Deer Park, NY 11729
800-229-AUTH
516-667-9000
Fax: 516-242-7742
Key Personnel: Jonathon Ingham, Pres.,
Donna Miller, VP, GM
Product Categories: B E

Auto-Security Products (ASP, Inc.)
P.O. Box 10
Redmond, WA 98073
206-556-1900
Fax: 206-558-1205
Key Personnel: Buddy Logan, Pres.,
Dick Brandon, VP, Steve Shain, Nat'l.
Sales Mgr.
Product Categories: F

B-E Industries Inc.
21 Annie Place
Stanford, CT 06902
203-357-8055
Key Personnel: Bruce Kahn

Badge-A-Minit
P.O. Box 800
LaSalle, IL 61301-0800
815-224-2090
Fax: 815-224-4594
Key Personnel: Debbie Bodnum, Mktg.
Dir.

Baldwin Hardware Corp.
841 E. Vyomissing Blvd.
Reading, PA 19607
610-777-7811
Fax: 610-775-5567
Key Personnel: Anthony Sturris, Pres.,
Rolin Sugg, VP Tech. Svc.
Product Categories: B F

Barry Supply Co./Div. of Barry Ind.
36 West 17th St.
New York, NY 10011
212-242-5200
Fax: 212-675-7094
Key Personnel: B. Wein, Sales, Andy
Seiler, Prod. Mgr.
Product Categories: B F

Base Industries
254 Ott St. F
Corona, CA 91720
800-554-8088
909-371-4465
Fax: 909-371-2828
Key Personnel: Scott Holmes, Brian
Huit, Owner, Tony Gillett, Tech.
Supp.
Product Categories: C E F

Baton Lock & Hardware Co.
14275 Commerce Dr.
Garden Grove, CA 92643
800-395-8880
714-265-3636
Fax: 714-265-3630
Key Personnel: Peace Hsu, Pres., Jamie
Wu, Sharon Hsu
Product Categories: B F G

Bell Detection Mirrors
894 Coney Island Ave.
Brooklyn, NY 11218
718-633-4000
Fax: 718-854-8909
Key Personnel: Art Brenner, GM
Product Categories: G

Belwith International, Ltd.
4300 Gerald R. Ford Fwy., P.O. Box
127
Grandville, MI 49418-0127
800-235-9484
616-531-4300
Fax: 616-531-6055
Key Personnel: Mark D. Pelley, Pres.,
Robert E. Schaub, VP Sales/Mktg.,
Donald K. Pegel, Dir. Mktg.
Product Categories: A F

Besam Automatic Door Systems
81 Twin Rivers Dr.
Hightstown, NJ 08520-5212
800-752-9290
609-443-5800
Fax: 609-443-3440
Key Personnel: Karen Maslow, Admin.
Mkg. Mgr.
Product Categories: E

Best Lock Corp.
P.O. Box 50444, 6165 E. 75th St.
Indianapolis, IN 46250
317-849-2250
Fax: 317-595-7620
Key Personnel:

Best Power Technology, Inc.
P.O. Box 280
Necedah, WI 54646
608-565-7200
Fax: 608-565-2221
Key Personnel: Steve Paul, Pres & CEO

Blackhawk Products
25913 County Rd. T5
Dolores, CO 81323
970-882-7191
Fax: 970-882-7228
Key Personnel: Roger Weitzenkamp
Product Categories: D G

Blue Camel Software
789 E. New England Dr.

Sandy, UT 84094
801-571-6372
Key Personnel: Garry Frogget

Boggs Tool Processing & File
Sharpening Co.
14100 Orange Ave.
Paramount, CA 90723
800-547-5244 (Outside California)
310-634-1081
Fax: 310-634-0839
E Mail: cbogg1@aol.com or
boggstool@aol.com
Key Personnel: Harry Boggs, Dir.,
Cheryl Boggs, Mkt Dir.
Product Categories: G

Bridgeman Security Equip.
510 W. Washington Blvd.
Montebello, CA 90640
800-334-6060
213-724-1287
Fax: 213-727-0236
Key Personnel: Eric Mueller, Pres., Ken
Young, VP/Sales
Product Categories: F H

Brown Safe Mfg.
439 W. San Marcos Blvd.
San Marcos, CA 92069
800-698-2358
619-744-4888
Fax: 619-744-4055
Key Personnel: Frederick L. Brown,
Pres.
Product Categories: E F H

Buddy Security Systems
1350 S. Leavitt
Chicago, IL 60608
800-886-8688
312-733-6400
Fax: 312-733-8356
Key Personnel: Sam Difiglio Sr., Pres.,
Daniel Sheard, Nat'l. Sales Mgr.,
Sandra Rivera, Sales Mgr. Lock. &
Har.
Product Categories: H

Build-A-Safe Inc.
15339 Pipeline Ln.
Huntington Beach, CA 92649
800-248-7233
714-892-1040
Fax: 714-572-9238
Key Personnel: Bob Lichter
Product Categories: H

Burle Philips Comm. & Sec. Sys. Inc.
1000 New Holland Ave.
Lancaster, PA 17601
800-326-3270
717-295-6123
Fax: 717-295-6097
Key Personnel: R.C. Rose, Pres. &
CEO, G.S. Brody, VP Mktg., W.O.
Hansen, Mgr. Comm.
Product Categories: A E

C&A Control Systems
4522 Doris Circle
Knoxville, TN 37918
800-346-0999
615-922-2148
Fax: 615-922-9999
Key Personnel: Alex Cantrell, Pres.,
Marvin Bone, Sales
Product Categories: A E

C & M Tool
See Major Manufacturing

Calibro Corp.
14911-127th St.
LeMont, IL 60439
800-915-2828
708-257-8008
Key Personnel: Darius Augustine
Product Categories: F

Product Category Key

- A — Alarms
- B — Architectural Hardware
- C — Training Manuals & Materials
- D — Locksmith Software
- E — Electronic Security Products
- F — Locking Products
- G — Locksmith Tools & Equipment
- H — Safes & Safe Products

Continued on page 72

Continued from page 70

California Security Cans
530 Cypress Ave.
Hermosa Beach, CA 90254
800-848-0067
310-374-7400
Fax: 310-372-2160
Key Personnel: Margaret Meenahan,
Bruce Menendez, Partner
Product Categories: H

Cannon Safe Inc.
9358 Stephens St.
Pico Rivera, CA 90660
800-242-1055
310-692-0636
Fax: 310-692-7252
Key Personnel: Steve Baker, Pres., Jess
Bugariz, Sales, Randy Linkmeyer,
Sales
Product Categories: H

Cansec Systems Ltd.
3105 Unity Drive., Unit 9
Mississauga, Ont., Canada L5L 4L2
905-820-2404
Fax: 905-820-0301
Key Personnel: Fred Dawber, Pres.

Cardkey Systems, Inc.
101 West Cochran St.
Simi Valley, CA 93065
805-522-5555
Fax: 805-522-9215
Key Personnel: Stuart Katcher, VP
Direct Sales, Mike Wolpert, VP Syst.
Prod. Group, Edie Gelardi, Mgr. Cust.
Comm.
Product Categories: E

CCL Security Products
199 Whiting St.
New Britain, CT 06051-4360
800-733-8588
203-229-6199
Fax: 203-223-7601
Key Personnel: Kevin G. Jacob, Dir.

Sales./Mktg., James Stafstrom, Nat'l.
Sales Mgr., Patricia M. Daigneault,
Nat'l Sales Mgr.
Product Categories: B F

CCTV Corp.
280 Huyler St.
S. Hackensack, NJ 07606
800-221-2240
201-489-9595
Fax: 201-489-0111
Key Personnel: Gary Perlin, Sales
Mgr., Steve Lefkowitz, Pres.
Product Categories: E

Cellular Alarm Prod., Ltd.
2575 Southwell, Ste. 104
Dallas, TX 75229
800-752-9719
214-620-0156
Fax: 214-620-7205
Key Personnel: Michael Lebowitz,
Man. Partner, Jerald Hopkins
Product Categories: E

Chicago Lock Co.
4311 W. Belmont Ave.
Chicago, IL 60641
312-282-7177
Fax: 312-282-8199
Key Personnel: Dale N. Padjen,
Sales/GM, John Nelligan, "Bo"
Bowditch
Product Categories: F

Chinon America, Inc.
1065 Bristol Rd.
Mountainside, NJ 07092
800-932-0374
908-654-0404
Fax: 908-654-6656
Key Personnel: Ken Gerb, Nat'l Sales
Mgr., Andy Smith, Sales Assoc.
Product Categories: E

Chugai Boyeki (America) Co.
1830 W. 208th St.
Torrance, CA 90501

310-618-8615
Fax: 310-618-9963
Key Personnel: Don Reeby, Sales Mgr.
East Coast, Jim Holihan, Sales Mgr.
West Coast, Ivanhoe Martines, Asst.
Sales Mgr.
Product Categories: E
Clifford Electronics, Inc.
20750 Lassen St.
Chatsworth, CA 91311
818-7097551
Fax: 818-407-1742

Cobalt Manufacturing Inc.
1020 Shady Oaks Dr.
Denton, TX 76205
817-382-8986
Fax: 817-383-4281
Key Personnel: Craig Watkins Sr.,
Pres., Dick Smith, CEO, Craig
Watkins, Jr., Prod. Mgr.
Product Categories: H

Commercial Van Interiors
8840 St. Charles Rock Rd.
St. Louis, MO 63114
800-759-7477
314-423-7477
Fax: 314-427-1525
Key Personnel: Steve Kloessner, Pres.,
Mark Siegen, VP
Product Categories: G
See ad on page 32

Conceal-A-Safe
15339 Pipelane Ln.
Huntington Beach, CA 92649
800-248-SAFE
714-892-1040
Key Personnel: Bob Lichter
Product Categories: H

Continental Micro, Inc.
P.O. Box 394
Park Ridge, IL 60068
708-692-3630
Fax: 708-318-6188

Key Personnel: Thomas Swiderek,
Pres., Lori Lane, VP
Product Categories: G

Continental Prod. - Software House
70 Hopper St.
Westbury, NY 11590
800-242-1961
516-334-0900
Fax: 516-334-0235
Key Personnel: John Banks, VP & GM,
Bob Weinstein, Op., Dave Curtiss,
Mktg.
Product Categories: E

Cor-Tech Mfg. Inc.
411 W. Gabrielson Rd., PO Box 582
Luverne, MN 56156
800-649-2252
507-283-9081
Fax: 507-283-9081
Key Personnel: Corey Stratten,
President, Thomas Sterrets, Sales Mgr.,
Marlin Krachs, Shop Foreman
Product Categories: F

Corbin Russwin Architectural
Hardware
225 Epicopal Rd.
Berlin, CT 06037
203-225-7411
Fax: 203-828-7266
Key Personnel: Lawrence T. O'Toole,
VP Sales & Mktg.
Product Categories: B C D E F G

Corby Industries, Inc.
1501 E. Pennsylvania St.
Allentown, PA 18103
800-652-6729
610-433-1412
Fax: 610-435-1963
Key Personnel: Glenn M. Matz, Pres.,
Tim Corby, GM, Rich O'Donnell,
Mktg.
Product Categories: E
See ad on page 7

MANUFACTURERS



**Every Installation
Is a Self-Portrait
Of the Person Who Did It.
Autograph Your Work with Excellence.**

[Click here for more information](#)

CorKey Control Systems, Inc.
8146 Mahler Rd.
Burlingame, CA 94010
800-622-2239
415-692-9495
Fax: 415-692-9410
Key Personnel: Lin Lepore, Operations
Mgr., David Dickes, Nat'l. Sales
Mgr., Robin Walin, Off. Mgr.
Product Categories: F

Cosmicar
35 Inverness Dr. East
Englewood, CO 80112
303-799-8000
Fax: 303-790-1612
Key Personnel: Warren Wright

Courtaulds Performance Films
P.O. Box 5068
Martinsville, VA 24115
800-255-8627
540-627-3000
Fax: 540-627-3032
Key Personnel: Virginia Kubler, Dir.
Sales/Mktg.
Product Categories: B F

Crimestopper Security Products, Inc.
1770 So. Tapo St.
Simi Valley, CA 93063
805-526-9400
Fax: 805-581-9500
Key Personnel: Howard Miller, Pres.,
Sharon Miller, VP, Larry Peterson, GM
Product Categories: A E

Custom Security Products
P.O. Box 3016
Simi Valley, CA 93093
805-522-5580
Fax: 805-522-9959
Key Personnel: Donald Hughes, Pres.,
John LaMel, Sales Mgr.
Product Categories: C F G

Customline, Inc.
950 W. Cienega Ave.
San Dimas, CA 91773
909-592-6200
Fax: 909-599-5776
Key Personnel: Michael Whiting, Sales

Cutler Mfg. Corp.
5204 US Hwy. 98 South
Lakeland, FL 33813-4203
800-237-2312
914-644-3573
Fax: 914-646-4517
Key Personnel: Kathie Guthrie, Sales
Supervisor
Product Categories: F

DADCO Mfg. Corp.
20 Lucan Dr.
Deer Park, NY 11729
800-DADCO NY
516-586-2400
Fax: 516-242-0611
Key Personnel: Bennett B. Harman,
Pres., Pearl Helman, Corp. Sec.,
Ronald Ling, Chief Eng.
Product Categories: A E

DALAX, Inc. / Hal Simon Co.
1314 Huntington Dr.
Richardson, TX 75080
214-234-8009
Fax: 214-234-0339
Key Personnel: Laurece D. Simon,
Helen H. Simon, Sec./Treas.
Product Categories: D

Darex Corp.
P. O. Box 277
Ashland, OR 97520
800-547-0222
503-488-2224
Fax: 503-488-2229
Key Personnel:
Product Categories: G
See ad on page 27

David Levy Company, Inc.
12753 Moore St.
Cerritos, CA 90701
800-421-3536
310-404-9998
Fax: 310-404-9698
Key Personnel: John Latino, Sales
Product Categories: C E

Dayton Safe Company
511 N. Findlay St.
Dayton, OH 45404
513-461-3900
Fax: 513-461-4044
Key Personnel: Sara Nagler, Pres.,
Elliot Nagler, GM, John McIntosh,
Plant Foreman
Product Categories: H

Defenders Network Inc.
860 Cottage Hill Ave.
Mobile, AL 36693-3919
800-513-1984
334-661-1244
Fax: 334-661-3143
Key Personnel: Helmut Julinot, H.
Julinot, VP, M. Switter, Operations
Product Categories: E

Delta Vehicle Security
9862 Glenoaks Blvd.
Sun Valley, CA 91352
800-356-9562
818-771-1127

Fax: 818-771-0785
Key Personnel: Jack Naldjian, Mktg.
Mgr., Joe Naldjian, Tech. Dir., Gary
Romero, Sales Mgr.
Product Categories: A E

Deronde Products, Inc.
200 Cornwall Ave., P.O. Box 243
Buffalo, NY 14215-0243
800-346-8926
716-895-8888
Fax: 716-895-9987
Key Personnel: Alexander Catalano,
Charles Long, Jr. Mgr. Of Oper.
Product Categories: B F

Detec Security Systems, Inc.
927 Calle Negocio, Ste. A
San Clemente, CA 92673
800-967-2446
714-366-9391
Fax: 714-366-9436
Key Personnel: Mike A. Sansky, Pres.
Product Categories: A E

Detex Corp.
302 Detex Dr.
New Braunfels, TX 78130
800-729-3839
210-629-2900
Fax: 210-620-6711
Key Personnel: John Blodgett, VP/GM,
Gary Hackney, Product Mgr. Hrdwe.
Div., Trice Kastein, Inside Sales Mgr.
Product Categories: A E F

Product Category Key

A — Alarms
B — Architectural Hardware
C — Training Manuals & Materials
D — Locksmith Software
E — Electronic Security Products
F — Locking Products
G — Locksmith Tools & Equipment
H — Safes & Safe Products



ASP Covers the World of Auto Locks

[Click here for more information](#)

MANUFACTURERS

Detroit Mini-Safe Co.
9950 Freeland
Detroit, MI 48227
313-931-7720
Fax: 313-931-7758
Key Personnel: Sheldon Wiener,
Owner

Diebold, Inc.
P.O. Box 8230, Dept. 9-79
Canton, OH 44711
216-489-4000
Fax: 216-588-3794

Digital Monitoring Products
2841 E. Industrial Dr.
Springfield, MO 65802
417-831-9362
Key Personnel: Rick Britton

DLA Security Systems, Inc.
629 Kimball Ave.
Westfield, NJ 07090
908-233-7755
Key Personnel: Walt Driscoll, Pres.
Product Categories: D

Dom Security Locks N.A.
100 Central Ave.
Brockville, Ont., Canada K6V 5W6
613-498-9415
Fax: 613-498-5820
Key Personnel: Jurgen Wolf, Gen.
Mgr., Olga Chalikias, Cust. Svc. Rep.
Domenic Cicchini, Tech. Svc. Rep
Product Categories: B E F

Domus Industries, Inc.
8550 E. 33rd St.
Indianapolis, IN 46226
317-898-8870
Fax: 317-898-1130
Key Personnel: Rino di Jorio, Pres.,
Chris Wilkes, VP Sales & Mktg.
Product Categories: B

Don-Jo Manufacturing
P.O. Box 929
Sterling, MA 01564
800-628-8389
508-422-3377
Fax: 508-422-3467
Key Personnel: Tim Roy, VP, Karen
Martin, Oper. Mgr.
Product Categories: B G

Door Aid® Div. of M.S.S.
500 N. Main St.
Mattawan, MI 49071
800-526-5672
616-668-0228
Key Personnel: David Carambula, Dir.
Sales & Mktg., Terry Sorong, Cust.
Svc. & Prod. Coord.
Product Categories: B

Door Controls Int'l.
2362 E. Bishop Circle E
Dexter, MI 48130
800-742-3634
313-426-0400
Fax: 800-742-0410
Key Personnel: John C. Maynard,
Pres., Joseph A. Ghergo, VP Sales &
Mktg., Barbara S. Maynard, VP Cust.
Rel.
Product Categories: A B E F

Door Spy - Rudolph-Desco Co., Inc.
580 Sylvan Ave., P.O. Box 1245
Englewood Cliffs, NJ 07632-1245
201-568-4920
Fax: 201-568-0971
Key Personnel: Hans Baumann Sr., VP,
Michael Simond, VP
Product Categories: B

Door Systems, Inc.
2935 Byberry Rd., P.O. Box 576
Hatboro, PA 19040-0576
215-672-8087
Fax: 215-672-8298

Key Personnel: David C. Deardorff
See ad on page 37

Doorguard Systems, Inc.
8970-C Route 108
Columbia, MD 21045
800-442-6247
410-992-5600
Fax: 410-992-5694
E Mail: doorguard@aol.com
Key Personnel: C. T. Croson, President
Jim Lawrence, Marketing Manager
Heather Szymanski, Sales Manager
Product Categories: E F

DoorKing, Inc.
120 Glasgow Ave.
Inglewood, CA 90301
310-645-0023
Fax: 310-645-7431
Key Personnel: Dusty Beeding, Sales
Dir.

Dor-O-Matic Inc.
4640 N. Oketo
Harwood Heights, IL 60656
800-815-1517
708-867-8500
Fax: 708-867-5227
Key Personnel: F.J. Chubbuck, Nat'l
Sales Mgr., Michael Murray, Sr. VP,
Mark Dugo, Prod. Mgr.,
Product Categories: B E

DORMA Door Controls Inc./The
DORMA Group
DORMA Drive, Drawer AC
Reamstown, PA 17567-0411
800-523-8483
717-336-3881
Fax: 800-274-9724
Key Personnel: Paul Kosakowski, Vice
President Sales & Mktg., Michael
O'Connor, National Sales Manager
Product Categories: B

Dortronics Systems, Inc.
1668 Sag Harbor Turnpike
Sag Harbor, NY 11963
800-906-0137
516-725-0505
Fax: 516-725-4234
Key Personnel: Paul R. Scheerer, Pres.,
John Fitzpatrick, VP Sales & Prod.,
Mary Scheere, VP Eng.
Product Categories: F

Dragoon Corporation
1330 Flynn Rd., Unit G
Camarillo, CA 93012
805-987-4911
Fax: 805-987-4358
Key Personnel: John Phillips

Dremel
4915 21st St.
Racine, WI 53406
414-554-1390
Fax: 414-554-7654
Key Personnel: Mike Brainerd, Mktg.
Serv. Mgr., Stephen J. Beardslee, VP
Sales, Bridget Crave, Mktg. Mgr.
Rotary Tools
Product Categories: G

Dudley Lock Inc.
544 Frontiere
Hemmingford, Que., Canada
800-363-1499
514-247-2744
Fax: 514-247-3341
Key Personnel: David Mountain, Pres.,
Laurent Denis, Sales Mgr.
Product Categories: F

DuPage Products Group
2250 Curtiss St.
Downers Grove, IL 60515
800-323-7208
708-968-6900
Fax: 708-969-0310
Key Personnel: Patrick Casey, Nat'l

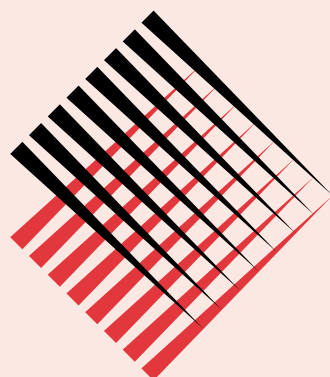

STRATTEC™

***The world's largest producer of
automotive locks and keys.***

[Click here for more information](#)

Sales Mgr., Candy Perry, Inside Sales
Svr.
Product Categories: F

Dynabrade, Inc.
8989 Sheridan Dr.
Clarence, NY 14150-1490
800-828-7333
716-631-0100
Fax: 716-631-2073

Key Personnel: Chip Case, Nat'l Sales
Mgr., Chip Case, Nat'l. Sales Mgr.,
Casey Maziarz, Cust. Svc. Mgr.
Product Categories: G

Dynalock Corporation
705 Emmett St.
Forestville, CT 06011
203-582-4761
Fax: 203-585-0338

Key Personnel: Ralph Sitnick, Pres.,
Richard Gladych, GM, John
Vanchirico, Cust. Svc. Mgr.
Product Categories: E F

Dynatech International Inc.
3594 West 1820 South
Salt Lake City, UT 84104
Key Personnel: Rob Sanchez

E.K. Ekcessories, Inc.
575 W. 3200 S.
Logan, UT 84321
801-753-8448
Fax: 801-753-2411
Key Personnel: Ed Kalbach, Pres.

Electro-Surgical Instrument Co.
37 Centennial St.
Rochester, NY 14611
716-235-1430
Fax: 716-235-1438
Key Personnel: Anthony J. McAndrews,
Pres., Eleanor A. Phelps, VP
Product Categories: G

Electronic Locking Specialties Inc.
2043 Wellwood Ave.
E. Farmingdale, NY 11735-1283
800-526-9000

516-753-6100
Fax: 516-753-6104
Key Personnel: John Fitzpatrick
Product Categories: E

Emergency Road Service, Inc.
275 E. Hillcrest, Ste. 203
Thousand Oaks, CA 91360
805-379-3766
Fax: 805-495-8238
Key Personnel:

Empire Safes
433 Canal St.
New York, NY 10013
800-543-5412
212-226-2255
Fax: 212-941-9073
Key Personnel: Richard Krasilovsky
Product Categories: H

Emtek Products, Inc.
15250 E. Stafford St.
City of Industry, CA 91744
800-356-2741
818-961-0413
Fax: 800-577-5771
Key Personnel: Tom Miller, Pres., Rick
Julian, VP Mktg., Don Wilkenson,
Cust. Svc. Mgr.
Product Categories: B F

Engineering Unlimited
1320 12th Ave. North
Minneapolis, MN 55411
800-515-4040
612-522-4040
Fax: 612-522-2829 or 800-515-
2829

Key Personnel: Joseph Werner, Pres.,
Suzanne Werner, VP
Product Categories: F

Envirotemp Corp./Frontier Safe Co.
3201 S. Clinton St.
Ft. Wayne, IN 46806
800-861-6131
219-744-7233
Fax: 219-744-6678

Key Personnel: Marcus Brewer, Pres.,
Fred Caesar, Sales, Dan McLean,
Prod. Mgr.
Product Categories: H

Escalera, Inc.
PO Box 1359
Yuba City, CA 95992
800-622-1359
916-673-6318
Fax: 916-673-6376
Key Personnel:
Product Categories: H

Esmet, Inc.
1406 Fifth St. SW
Canton, OH 44702
216-452-9132
Fax: 216-452-2557
Key Personnel: Dot Pullin, Sales

ESP Lock Products
375 Harvard St.
Leominster, MA 01453
508-537-6121
Fax: 508-537-1699
Key Personnel: Vince Spadafora, VP,
Sales, Sue Miller, Sales Mgr., Nunzio
Nano, Mktg. Dir.
Product Categories: F G

Essex Electronics Inc.
1130 Mark Ave.
Carpinteria, CA 93013
800-539-5377
805-684-7601
Fax: 805-684-0232
Key Personnel: Michael Kaufman, Dir.
Sales & Mktg.
Product Categories: E F

Excalibur of America
981 Burnt Hickory Rd.
Douglasville, GA 30134
404-942-9876
Fax: 404-942-9632
Key Personnel: Ron Murphy, Nat'l
Sales Mgr.

Exit Security Inc.
1312-E Colony Court
Fort Worth, TX 76117
800-446-6775
817-429-6666
Fax: 817-831-6063
Key Personnel: Ralph Roden
Product Categories: F

Exxis Technologies
1220 Champion Circle
Carrollton, TX 75006
214-280-9695
Fax: 214-280-9613
Key Personnel: Chad Jendsen

Facilitrac®
64 E. Broadway, Ste. 230
Tempe, AZ 85282
602-967-8617
Fax: 602-921-0892
Key Personnel: Mike Marinello, Mktg.
Dir.

Farfisa Intercoms
9600 NW 25th St.
Miami, FL 33172
800-806-0227
305-593-0227
Fax: 305-593-9823
Key Personnel: Marcelo Paez, General
Mgr.
Product Categories: E

Federal Lock Company
1320 Enterprise Dr.
Romeoville, IL 60441
800-682-9851

Product Category Key

- A — Alarms
- B — Architectural Hardware
- C — Training Manuals & Materials
- D — Locksmith Software
- E — Electronic Security Products
- F — Locking Products
- G — Locksmith Tools & Equipment
- H — Safes & Safe Products

medeco®
HIGH SECURITY LOCKS

**Integrity. Ingenuity....
security solutions.**

[Click here for more information](#)

708-378-4745
Fax: 708-378-4767
Key Personnel: Cory McNaughton,
Fac. Mgr., Loring Johnson, Dir. Prod.
Eng., John Dignan, Nat'l Sales Mgr.
Product Categories: F
See ad on page 45

Folger Adam Company
16300 W. 103rd St.
Lemont, IL 60439
708-739-3900
Key Personnel: Kenneth R. Erickson, VP
Arch. Sec. Prod. Daniel R. Nicholson,
Prod. Mgr., Arch. Sec. Prod. Shar
Tintinger, Marketing Coordinator
Product Categories: B C E F

Fort Knox Security Products
1051 No. Industrial Park Rd.
Orem, UT 84057
801-224-7233
Fax: 801-226-5493
Key Personnel: T.J. James, Pres.

Fort Lock Corp.
3000 N. River Rd.
River Grove, IL 60171
708-456-1100
Fax: 708-456-9476 or 456-1197
Key Personnel: Lloyd Falk, Pres., Larry
Kern, Nat'l. Sales Mgr. Dist., Tom
Butler, Cust. Svc. Dist.
Product Categories: A B C E F G
See ad on page 133

Frame, Inc.
578 S. State College Blvd.
Fullerton, CA 92631
800-372-6346
714-441-0544
Fax: 714-441-0543
Key Personnel: Michael Murphy, Sales
Specialist, Liz McClure, Sales Asst.
Product Categories: E

Framon Manufacturing Co. Inc.
909 Washington Ave.
Alpena, MI 49707
517-354-5623
Fax: 517-354-4238
Key Personnel: Mike Agius, VP, Ann
Agius, Sec. Treas., Phil Agius, VP
Sales
Product Categories: G
See ad on page 86

Franklin Manufacturing/Div. of
Embassy
300 Smith St.
Farmingdale, NY 11735
516-694-1800
Fax: 516-694-1836
Key Personnel: Lawrence Franklin,
Pres., Jesse Taub, Nat'l. Sales Mgr.,
Gerry Ann Markowitz, Admin. Asst.
Product Categories: F

Frontier Safe Co.
3201 S. Clinton St.
Fort Wayne, IN 46806
219-744-7233
Fax: 219-744-6678
Key Personnel: Marcus Brewer, Pres.

G-U Hardware Inc.
11761 Rock Landing Dr. (M-6)
Newport News, VA 23606
800-927-1097
804-873-1097
Fax: 804-873-1298
Key Personnel: Kevin McDaniel, VP,
Barry Chenault, Cust. Svc. Rep., Dan
Alexander, Nat'l Sales Rep
Product Categories: B

Gainsborough Hardware Ind. Inc.
1255 Oakbrook Dr., Ste. C
Norcross, GA 30093
800-845-5662
404-448-9000
Fax: 404-448-7070
Key Personnel: Steve Jackson, Pres.,
Joe Welsh, Nat'l. Acct. Mgr., Cheryl
Swansey, Sales Coord.
Product Categories: B

Gardall Safe Corp.
219 Lamson St., PO Box 30
Syracuse, NY 13206

800-722-7233
315-432-9115
Fax: 315-434-9422
Key Personnel: Edward W. Baroody,
Pres., Caroline Barnicott, Nat'l. Sales
Mgr., Andy Ash, Dir. Training & Mktg.
Svc.
Product Categories: H

General Tool & Die Co., Inc.
1420 Ninth St.
Racine, WI 53403
414-632-0286
Key Personnel: Frank Holding, Prod.
Mgr.

Glynn Johnson
2720 Tobey Dr.
Indianapolis, IN 46219
800-525-0336
317-894-9440
Fax: 800-525-0337
Key Personnel: Robert M. Brokamp,
Sales Mgr., Donald K. Woody, GM
Product Categories: B

GNI
P.O. Box 1675
Santa Rosa, CA 95402-1675
800-533-6423
707-528-8083
Fax: 707-528-8085
Key Personnel: David A. Kesselman,
Pres.
Product Categories: F

Granite Security Products, Inc.
5216 David Strickland Rd.
Ft. Worth, TX 76119
817-561-9095
Fax: 817-478-3056
Key Personnel: Kyle Walters, Becky
Walters, Sales/Cust. Svc.
Product Categories: H

GT85 International, Inc.
P.O. Box 21185
St. Petersburg, FL 33742
800-525-GT85
813-522-7785
Fax: 813-526-1234
Key Personnel: Jon G. Miller, President
Product Categories: G
See ad on page 23

GTO, Inc.
3121 Hartsfield Rd.
Tallahassee, FL 32303
800-543-GATE
904-575-0176
Fax: 904-575-8912
E Mail: 670@supernet.net
Key Personnel: Chuck Mitchell, Pres.,
Wayne Payne, Sr. VP, Linda Williams,
Sales Dir.
Product Categories: E F

Guard Security Hardware
808 Georgia Ave.
Brooklyn, NY 11207
800-221-6895
718-272-1540
Fax: 718-272-8335
Key Personnel: Robert Winterstein, VP,
Mark Campbell, Sales Mgr., Lou
Ennis, Cust. Svc.
Product Categories: F

Gun Vault, Inc.
7735 E. Redfield Rd., Ste. 400
Scottsdale, AZ 85260
800-622-4903
602-951-6855
Fax: 602-951-6844
Key Personnel: Thomas Loeff, Pres.
Product Categories: H

GYR, An Odetics Division
1515 South Manchester Avenue
Anaheim, CA 92802-2907
800-854-6853
714-772-1000
Fax: 800-388-6363
E Mail: jmb@odetics.com
Thomas S. Pappageorge, Dir. Sales &
Mktg., Dominic Isola, Senior Sales
Mgr. Johnnie Billmire, Office Mgr.
Product Categories: E

H-T Typo Inc.
67-09 61st Rd.
Middle Village, NY 11379
718-894-3321
Fax: 718-894-2674
Key Personnel: Norbert Langsam
Product Categories: E

H.B. Ives
62 Barnes Park North
Wallingford, CT 06492
203-294-4837
Fax: 203-284-1460
Key Personnel: Stacey Callahan,
Contract Market Mgr., Philip Avila,
Nat'l. Sales Mgr. East, Timothy
O'Kane, Nat'l. Sales Mgr. West
Product Categories: B

Hager Hinge Co.
139 Victor St.
St. Louis, MO 63104
800-325-9995
314-772-4400
Fax: 800-782-0149
Key Personnel: Warren Hager, VP
Roton Div., Matt Bouchard, Roton Div.
Product Categories: B

Hamilton Safe Group
96 N. Sunnyslope Ave.
Pasadena, CA 91107
800-634-7366
818-796-3133
Fax: 818-796-1756
Key Personnel: Dan Prestler, John Kelly,
CEO Penn Hamilton
Product Categories: H

Hammerlock Industries
10120 Bird Rd.
Miami, FL 33165
800-755-8345
305-552-8345
Fax: 305-223-6097
Key Personnel: Bob Hammer
Product Categories: F

Hampton Products International
35 Hammond St.
Irvine, CA 92718
800-562-5625
714-472-4256
Fax: 714-472-9657
Key Personnel: Kim Kelley, Pres., Bob
Wilkosz, VP Sales, John Neeley,
Western Sales Mgr.
Product Categories: F

**Hanchett Entry Systems, Inc
/H.E.S. Inc.**
21622 N. 7th Ave.
Phoenix, AZ 85027
800-626-7590
602-582-4626
Fax: 602-582-4641
Key Personnel: Leland J. Hanchett Jr.,
Pres., Michael A. Webb, VP Mktg.
David S. Smith, Nat'l. Sales Mgr.
Product Categories: E
See ad on page 87

Hardware Technologies Ltd.
1120 N. Main St, PO Box 158
Ft. Atkinson, WI 53538-0158
414-563-2626
Fax: 414-563-4408
Key Personnel: Sandro Kurz, GM,
Scott Trogner, Prod. Mgr., Lynn
McAllister, Cust. Svc.
Product Categories: B F

Harloc Inc.
501 Railroad St.
Taylorsville, KY 40071
800-5 HARLOC
502-477-8822
Fax: 502-477-8831
Key Personnel: Wayne A. Kolbus,
Pres., J. Alan West, VP Sales, Michael
Sigmund, Dir. Mktg.
Product Categories: F

Harrison Electronic Systems
51 Gravel St., P.O. Box 1758
Wilkes-Barre, PA 18705
800-422-5050
717-825-0540
Fax: 717-823-6343
Key Personnel: Karen Keefer, Pres.,

Griff Keefer, VP Sales-Mktg., Bob
Justice, International Sales Mgr.
Product Categories: A E F

Hayman Safe Co., Inc.
1295 N. S.R. 426
Oviedo, FL 32765
800-444-5434
407-365-5434
Fax: 407-365-8958
Key Personnel: Gary Hayman, W.F.
Hayman, Pres.
Product Categories: H

Henry A. Evers Corp.
72 Oxford St.
Providence, RI 02905
800-553-8377, 800-55-EVERS
401-781-4767
Fax: 401-781-9581
Key Personnel: Rosemarie Naismith,
Sales Mgr., Anthony J. Dilorio, Pres.
Product Categories: G

Hercules Industries, Inc.
Box 197, 7194 St. Rt. 203
Prospect, OH 43342
800-345-2590
614-494-2628
Fax: 614-494-2274
Key Personnel: Ray W. Miller, Pres.,
Ronald D. Rowland, VP, David P.
Hook, Dir. Of Oper.
Product Categories: F

HEWI Inc.
2851 Old Tree Dr.
Lancaster, PA 17603
717-293-1313
Fax: 717-293-3270
Key Personnel: Ernest W. Winter, VP
Sale/Mktg., J. Hugh Rose, Nat'l.
Sales Mgr.
Product Categories: B

Hide-A-Safe
15339 Pipeline Ln.
Huntington Beach, CA 92649
800-892-6275
714-892-1040
Fax: 714-572-9238
Key Personnel: Bob Lichter, Pres.
Product Categories: H

High Security - 777 USA Lock
100 S. Hamelton, P.O. Box 398
Chandler, AZ 85244
602-899-7770
Fax: 602-814-0000
Key Personnel: Dr. Alois Crepinsek,
Pres.
Product Categories: B F

High Tech Tools
1400 SW 1st St.
Miami, FL 33135
800-323-8324
305-649-7014
Fax: 305-541-0074
Key Personnel: Tony Vigil
Product Categories: G

Hill Security Products
711 E. Walton Ave.
Spokane, WA 99207-3099
800-722-1142
509-487-1142
Key Personnel: Ruth E. Bower,
Owner/Mgr., Toki Miller, Exec. Asst.,
Ilean Nelson, Prod. Mgr.
Product Categories: G

Hirsch Electronics Inc.
2941 Alton Parkway
Irvine, CA 92714
714-250-8888
Fax: 714-250-7372
Key Personnel: Larry Midland, Pres.,

Product Category Key

- A — Alarms
- B — Architectural Hardware
- C — Training Manuals & Materials
- D — Locksmith Software
- E — Electronic Security Products
- F — Locking Products
- G — Locksmith Tools & Equipment
- H — Safes & Safe Products

Continued on page 78

Continued from page 76

L.W. Midland, Pres., Richard W. Foster, Jr. Exec. VP
Product Categories: A E

Honeywell Home Control
1985 Douglas Dr. N.
Golden Valley, MN 55422
800-328-5111
612-951-3678
Fax: 612-954-6799
Key Personnel: Tim Walker, Dir., Scott Buckman, Mgr. Home Sec.
Product Categories: A E

Horizon Safe Manufacturing
7034 S. Elmer Ave.
Whittier, CA 90602
800-624-7233
310-698-0789
Fax: 310-945-4846
Key Personnel: Kim Glaesco, Owner, Corey Edwards, Sales Mgr., Kenny Lussier, Dir. Mktg.
Product Categories: H

Horton Automatics
4242 Baldwin
Corpus Christi, TX 78405
800-531-3111
512-888-5591
Fax: 512-888-6510
Key Personnel: Lew Hewitt, Pres., Don Moerbe, VP Sales/Mktg., Ron Reich, Controller
Product Categories: B E

HPC, Inc.
3999 N. 25th Ave.
Schiller Park, IL 60176
800-323-3295
708-671-6280
Fax: 708-671-6343
Key Personnel: Jerry Hoffman, President, Alan Blitstein, VP-Sales, Francine Hoffman, VP-Mktg., Alan Goeke, VP-Operations
Product Categories: C D G H
See ads on pages 2, 13 & 35

Hurd Lock & Mfg. Co. Inc./Div. Avin Int'l
603 Bohannon Ave.
Greenville, TN 37743
615-639-4101
Fax: 615-639-0266
Key Personnel: Steve Bone, Pres.

Hydrosorbent Co.
25 School St.
Ashley Falls, MA 01222
800-448-7903
413-229-2967
Fax: 413-229-8743
Key Personnel: Brady Brown, Pres., Shelley Brooks, Office Mgr.
Product Categories: H

Identacard Technologies Corp.
1824 Colonial Village Ln.
Lancaster, PA 17605
717-299-3610
Fax: 717-299-4122
Key Personnel: Brent W. Iles, VP/GM, Rob Munro, Nat'l. Sales Mgr., Cindy Zearfoss, Mktg. Support
Product Categories: E

Ikegami Electronics USA Inc.
37 Brook Ave.
Maywood, NJ 07607
201-368-9171
Fax: 201-368-1305
Key Personnel: Aaron Chesler

Ilco Unican
400 Jeffreys Rd.
Rocky Mount, NC 27804
800-334-1381
919-446-3321
Fax: 919-446-4702
Key Personnel: Aaron Fish, Chairman of the Board, Peter Blaikie, Pres., Donald S. Wright, Exec. VP
Product Categories: A E F G H

Ilco Unican/Marlok Division
2941 Indiana Ave.
Winston-Salem, NC 27105
800-849-8324

910-725-1331
Fax: 910-725-3269
Key Personnel: Michael J. Mahon, Nat'l. Sales Mgr., Jawa Thomas, Engineer, Sue Iskander, Exec. Sec.
Product Categories: A E F

Illinois Lock Co./Div. of The Eastern Co
301 W. Hintz Rd.
Wheeling, IL 60090
800-733-3907
708-537-1800
Fax: 708-537-1881
Key Personnel: Brian D. Reed, Man. Dir., Paul Spletzer, GM, Timothy Laabs, Eng. R & D Mgr.
Product Categories: F

In-A-Floor Safe Co.
P.O. Box 1194
Cedar Glen, CA 92321-1194
909-337-9116
Fax: 909-337-8286
Key Personnel: Carl L. Belknap, Flora W. Belknap, Partner
Product Categories: H

Indiana Cash Drawer Co.
1315 S. Miller St., P.O. Box 236
Shelbyville, IN 46176
800-227-4379
317-398-6643
Fax: 317-392-0958
Key Personnel: Robert Benavides, VP Sales & Mktg., Catherine Woods, Mktg. Comm.
Product Categories: E H

Infographic Systems Corp.
4442 Corporate Center Dr.
Los Alamitos, CA 90720
714-220-4980
Fax: 714-828-5763
Key Personnel: Doug Graham, Exec. Director, John Finamore, V.P. Sales
Product Categories: E F

Innovative Moving Systems, Inc.
310 S. 10 St.
Oostburg, WI 53070
800-619-0625
414-564-6272
Fax: 414-564-2322
Key Personnel: Steve Harrison, Pres., Bill Harrison, VP, Elmer Hazen, Sales Mgr.
Product Categories: H
See ad on page 34

Intelligent Controls Inc.
6825-216th St. SW
Lynnwood, WA 98036
800-842-0221
206-771-8107
Fax: 206-775-1641
Key Personnel: Jeffrey R. Kruse, Exec. VP, Rex Pardo, Nat'l. Sales Mgr., Jeffrey Hovorka, Product Mgr.
Product Categories: C E

Intellikey
551 S. Apollo Blvd., Suite 204
Melbourne, FL 32901
407-724-0700
Fax: 407-724-0811
Key Personnel: Frank Tsamoutales

Intelock Technologies
5627 Gibraltar Dr.
Pleasanton, CA 94566-9018
800-562-5875
510-225-0300
Fax: 510-225-0600
Key Personnel:
Product Categories: E F

International Electronics Inc.
427 Turnpike St.
Canton, MA 02021
800-343-9502
617-821-5566
Fax: 617-821-4443
Key Personnel: John Waldstein, Pres./CEO, H. Scott Kirkpatrick, Dir. Sales & Mktg., Brad Sampson, Prod. Mgr.
Product Categories: E

International Locking Devices Ltd.
104-4 Branford Rd.
No. Branford, CT 06471
800-863-9600
203-481-6738
Key Personnel: Bill Lalani, Pres., Ed Perkins, Sales
Product Categories: F

Intersek
4009 So. Pearl Street
Englewood, CO 80110
303-871-1413
Fax: 303-788-1899
Key Personnel: Brian Hambleton, President, Dick Lotz, V.P., Lorraine Hambleton, V.P.
Product Categories: C E F H

Intralock Tools Ltd.
2629 Progressive Way, Bldg. 2, unit B
Abbotsford, B.C., Canada V2T 6H8
604-852-8904
Fax: 604-852-8938
Key Personnel: Gordon Parr, Pres., Jim Brooks, VP
Product Categories: G

ISM/SPC - Israel Safe Manufacturing
100 Bomont Pl.
Tolowa, NJ 07512
201-808-1233
Fax: 201-882-6625
Key Personnel: Darron Brouard, ISM Mktg. Mgr.
Product Categories: H

Italbrass Corporation
21 Lime St.
Marblehead, MA 01945
617-639-1992
Fax: 617-639-2458
Key Personnel: Dwight Jenning, MG Oper.
Product Categories: B

JADO Bathroom & Hardware Mfg. Corp.
4690 Calle Quetzal
Camarillo, CA 93012
805-482-2666
Fax: 805-484-4799
Key Personnel: Richard Wickham, Mktg. Mgr.

Jensen Tools, Inc.
7815 S. 46th St.
Phoenix, AZ 85044
800-426-1194
602-968-6231
Fax: 800-366-9662
Key Personnel: Gary Treiber, Mktg. Mgr., Pete Sturman, GM
Product Categories: G

Jet Hardware Mfg. Corp.
800 Hinsdale St.
Brooklyn, NY 11207
718-257-9600
Fax: 718-257-0973
Key Personnel: Alfred Schonberger, Pres., Fred Lang, VP, George Buchinger, Sec./Treas.
Product Categories: F
See ad on page 50

Jon's Lock & Key
8918 S. 700 E.
Sandy, UT 84070
801-255-1003
Key Personnel: John Vawdrey, Owner, David Vawdrey, VP, Greg Taylor
Product Categories: G

JS Products Inc.
4083 S. Industrial
Las Vegas, NV 89103
800-255-7011
702-362-7011
Fax: 702-362-5084
Key Personnel: Steve Brantley, Pres., Juan Mora, VP Sales/Mktg., Allen Sharpless, VP Sales/Mktg.
Product Categories: G

Kaba High Security Locks
P.O. Box 490, Old Turnpike Rd.
Southington, CT 06489
203-621-3601
Fax: 203-621-9727

Key Personnel: Tom DiVito, CEO, John Bergstrom, Sales & Mktg. Mgr.
Product Categories: E F

Kaddies Inc.
P.O. Box 342
Walnut Creek, CA 94597
800-523-KADDIES
510-934-4488
Fax: 510-934-4492
Key Personnel: Tom Shetterly, Nat'l Sales Mgr.
Product Categories: G

Ke-Master
60 Starlifter Ave.
Dover, DE 19901
Key Personnel: Penny Reiss, Nat'l. Sales Mgr.

Keedex Manufacturing
12931 Schackelford Ln.
Garden Grove, CA 92641-5108
714-636-5657
Fax: 714-636-5680
Key Personnel: Cormac "Mac" Dorsey, Nat'l Sales Mgr., Julie McCluney, Partner, George Hill, Partner
Product Categories: B E G H
See ad on page 37

Keefe Mfg. Co.
23 Lexington Ave.
Trenton, NJ 08618
609-882-2290
Fax: 609-882-1698
Key Personnel: John Keefe, John R. Keefe
Product Categories: G

Kenstan Lock & Hardware Co.
166 West Hills Rd.
Huntington Station, NY 11746
800-859-7874
516-271-2755
Fax: 516-271-2759
Key Personnel: Hans Bosch, Pres., Bob Harrison, VP Operations, Alan Lurie, Mgr. Oper.
Product Categories: F
See ad on page 53

Kent Moore
29784 Little Mack
Roseville, MI 48066
800-345-2333
810-574-2332
Fax: 800-578-7375
Key Personnel: Bob Kindig, Sales & Mktg. Mgr., Todd Downs, Prod. & Prom. Coord.
Product Categories: G

Keri Systems, Inc.
1530 Old Oakland Rd. #120
San Jose, CA 95112
800-260-5265
408-451-2520
Fax: 408-441-0309
Key Personnel: Ted Geiszler, Pres., Chuck Fontana, GM, Susi McCarthy, Mktg. Mgr.
Product Categories: E

Kett Tool Co.
5055 Madison Rd.
Cincinnati, OH 45227
513-271-0333
Fax: 513-271-5318
Key Personnel: H. Rowe Hoffman, Chairman
See ad on page 53

Key Sales & Supply Co., Inc.
9950 Freeland Ave.
Detroit, MI 48227
800-445-5397
313-931-7720

Product Category Key

- A — Alarms
- B — Architectural Hardware
- C — Training Manuals & Materials
- D — Locksmith Software
- E — Electronic Security Products
- F — Locking Products
- G — Locksmith Tools & Equipment
- H — Safes & Safe Products

Continued on page 82

Continued from page 78

Fax: 313-931-7758
Key Personnel: Michael Wiener, Sales Mgr., Sheldon Wiener, Pres.
Product Categories: F H
See ad on page 54

Key Sure
P.O. Box 439 Prince Station
New York, NY 10012-0008
212-219-0015
Fax: 212-219-0015
Key Personnel: Len Sideri, CEO
Product Categories: F

Key Systems, Inc.
948 Culver Rd.
Rochester, NY 14609
800-888-3553
716-654-9388
Fax: 716-654-7916
Key Personnel: George Eckerdt, Pres., Bruce Fredericks
Product Categories: E H

KEY-BAK; A Div. of West Coast Chain Mfg. Co.
1460 S. Balboa Ave.
Onario, CA 91761
909-923-7800
Fax: 909-923-0024
Key Personnel: Craig Paugh, Pres., John J. Iacono, VP, Shirley Paugh, Mktg. Mgr.
Product Categories: E G

Keydex International Inc.
P.O. Box 1887
Oldsmar, FL 34677-0034
813-785-3535
Fax: 813-785-7627
Key Personnel: Howard A. Osofsky, Pres., Barbara J. Osofsky, EVP
Product Categories: F

KeySoft Masterkey Software
854 S. Redwood Rd.
Salt Lake City, UT 84104
801-972-1369
Fax: 801-972-1369
E Mail: prodigy tmy 82a
Key Personnel: Rick Wilkinson, Pres., Melanie Wilkinson, VP
Product Categories: D G
See ad on page 44

Keystone Novelty Co. Inc.
137-17 71st Ave.
Flushing, NY 11367
718-544-1734
Fax: 718-544-1872
Key Personnel: Hy Korn
Product Categories: G

Keystone Safe Distributors
P.O. Box 502
Huntingdon Valley, PA 19006-0502
Key Personnel: Edward C. Dornisch, Pres.

Killeen Security Products
33 Hermon St.
Worcester, MA 01610
800-577-5397
508-754-1714
Fax: 508-753-2183
Key Personnel: Norman Doucet, President, Doug Maston, Vice President
Product Categories: F
See ad on page 55

Kinduell Screen Printing
110 Center St.
Wilder, KY 41071-2998
800-354-9877
606-581-5444
Fax: 606-581-2322
Key Personnel: Angela Zapp, Cust. Svc., Karen Young, Cust. Svc. Rep., Michael Peeler
Product Categories: G

KingAlarm
35 Green St.
Hackensack, NJ 07601
800-526-0162
201-488-4990
Fax: 201-342-6194
Key Personnel: Yvette Ferry, Nat'l. Sales Mgr., Nick Searare, Sales Mgr.,

Allen Saget, Senior VP
Product Categories: A C

Knaack Mfg. Co.
420 E. Terra Cotta Ave.
Crystal Lake, IL 60014
800-456-7865
815-459-6020
Fax: 815-459-9097
Key Personnel: Brad Fagala, Prom. Mgr., Rick Bielski, Nat'l. Sales Mgr., Pete Edwards, Fleet Sales Mgr.
Product Categories: G

Knight Safe Mfg.
9155 Archibald Ave., Suite 202
Rancho Cucamonga, CA 91730
800-USA-BILT
909-483-3333
Fax: 909-483-3336
Key Personnel: Leland, Scheu, GM, Howard Rogers, Sales & Prod., Mary Sheedy, Cust. Svc.
Product Categories: H

Knox Company
17672 Armstrong
Irvine, CA 92714
800-552-5669
714-252-8181
Fax: 714-252-0482
Key Personnel: Dohn Trempala, Pres.
Product Categories: B E

Kryptonite Corp.
320 Turnpike St.
Canton, MA 02021
800-SAY-LOCK (729-5625)
617-828-6655
Fax: 617-821-4777
Key Personnel: Michael Zane, CEP, Stephen Bates, Sales Mgr., Karen Rizzo, Mktg. Mgr.
Product Categories: F

Kustom Key Inc.
1010 Aviation Dr.
Lake Havasu City, AZ 86404
800-537-5397
520-453-8338
Fax: 800-235-4728
Key Personnel: Dave Vedder, Pres., Michael Vedder, GM, Tony Profera, Dir. Mktg.
Product Categories: G
See ad on page 26

Kwikset Corporation - A Black & Decker Comp.
One Park Plaza, Ste. 1000
Irvine, CA 92714
714-474-8800
Fax: 714-474-8862
Key Personnel: Dennis Heiner, Pres., Tom Haapala, VP Mktg., Mike Convey, VP Sales
Product Categories: F

KXL Corp.
3010 N. River Rd.
River Grove, IL 60171
708-453-1788
Fax: 708-456-9476
Key Personnel: Sidney Falk, CEO, Martin Alvarez, Asst. Mgr., Laura Rodriguez, Control
Product Categories: A E F

L&S Security Products
13418 Halldale Ave., P.O. Box 1337
Gardena, CA 90249
310-532-4988
Fax: 310-532-4988
Key Personnel: Ms. Angela Mandic, US Sales Mgr.
Product Categories: A B E F

L.J. Security Products
156 S. Meridith St., Unit 113
Pasadena, CA 91106
818-242-3156
Key Personnel: Y.J. McCall, Pres., L. McCall, VP Sales, D.A. Latour, VP Admin.
Product Categories: F H

La Gard Inc.
3330 Kashiwa St.
Torrance, CA 90505

310-325-5670
Fax: 310-325-5615
Key Personnel: Larry Cutter, Pres., Susan Gartner Papa, GM
Product Categories: E F

LAB Security
700 Emmett St.
Bristol, CT 06010
800-243-8242
203-589-6037
Fax: 203-583-7838
Key Personnel: Robert A. Labbe, Chmn. & Pres., Gerald G. Roraback, Exec. VP, Crosby J. Kelly, VP Sales & Mktg.
Product Categories: F G
See ad on page 195

Ladyfayre Holdings Ltd.
#527-7620 Elbow Drive SW
Calgary, AB, Canada T2V 1K2
403-258-2588
Fax: 403-640-4215
Key Personnel: M. Benson, Pres., L.J. Benson, Sec. Treas.
Product Categories: F G

Lanson Industries
South 82 West 18717 Gemini Dr.
Muskego, WI 53150
414-679-0045
Fax: 414-679-2505
Key Personnel: Jim Scott, Pres. CEO, Gerald R. Luetgen, VP Sales, J. McGraw, Corporate Sec.
Product Categories: B E

Latch-Gard Co., Inc.
P.O. Box 425, 110 South Elkhart
Wakarusa, IN 46573-0425
219-862-2373
Fax: 219-862-2459
Key Personnel: Randall Moyer, Pres., David Geiger, VP
Product Categories: B F

LCN Closers
121 W. Railroad Ave.
Princeton, IL 61356
815-875-3311
Fax: 815-875-3222
Key Personnel: R.C. Ivey, Mktg. Dir.

Lee Electric, Inc.
309-11 51st St.
West New York, NJ 07093
800-433-3417
201-866-3656
Fax: 201-866-0735
Key Personnel: Mark Abramowitz, Andrew Abramowitz, Sales Mgr.
Product Categories: E F G

LeFebure Corporation
308 29th St. NE
Cedar Rapids, IA 52406
Key Personnel: Joseph Patton, Pres.

LeRoy Edenburn Enterprises
57 N. Huron St.
Ypsilanti, MI 48197
313-483-2444 or 313-483-6777
Fax: 313-485-8769
Key Personnel: LeRoy Edenburn, RL, CPS
Product Categories: G

Liberty Hardware Mfg. Co.
928 Alton Pl.
High Point, NC 27365
800-LIBERTY
910-434-5051
Fax: 910-434-3364
Key Personnel: Ray Plunkett, Nat'l Sales Mgr., Karon Walls, Acct. Rep., Donnie Snow, Acct. Rep.
Product Categories: B F G

Liberty Safe & Security Products, Inc.
1060 Spring Creek Place
Springville, UT 84663-3037
800-247-5625
801-489-8550
Fax: 801-489-6409
Key Personnel: Jay Crosby, President, James Skousen, Marketing Director
Product Categories: H
See ad on page 40

Lifetime Products
3726 US Hwy. 34 Box 465
Kewanee, IL 61443
800-369-5365
309-853-3387
Fax: 309-853-3389
Key Personnel: Jim Themanson, Prod. Mgr.
Product Categories: H

Linde Resources
11718 Barrington Ct., Ste. 260
Los Angeles, CA 90049
310-285-3143
Fax: 310-440-5562
Key Personnel:

Lindustries, Inc.
P.O. Box 66295
Auburndale, MA 02166-0003
617-237-8177
Key Personnel: Bill & Louise Lind
Product Categories: F G
See ad on page 36

Lion Security Products
2611 Ulysses St. NE
Minneapolis, MN 55418
800-477-7657
612-789-7657
Fax: 612-789-2795
Key Personnel: Sal DiLeo, Pres., Beth Kirby, Nat'l. Sales Mgr., Dean Nelson, Nat'l. Mktg. Dir.
Product Categories: A E

Lisle Corp.
807 East Main
Clarinda, IA 51632
712-542-5101
Fax: 712-542-6591
Key Personnel: John Lisle
Product Categories: G

Lloyd Matheson Inc.
P.O. Box L
Charleston, NH 03603
603-826-5777
Fax: 603-826-4186
Key Personnel: Evan Matheson

LLumar Magnum
P.O. Box 5068
Martinsville, VA 24115
703-629-1711
Fax: 703-629-8333
Key Personnel: Virginia Kubler

LMS Enterprises
10421 Burnham Dr. NW
Gig Harbor, WA 98335
206-858-9848
Key Personnel: Larry Stevens

Lock Corporation of America
Hwy. 14 North, P.O. Box 71
Viroqua, WI 54665-0071
608-637-8428
Fax: 608-637-8427
Key Personnel: Thomas F. Rust, GM, Karen M. Brueggen, Office Mgr.
Product Categories: F

Lock Technology Corp.
685 Main St.
New Rochelle, NY 10801
914-632-4372
Fax: 914-632-6407
Key Personnel: Frank Nagel, Pres.
Product Categories: F G

Lock Technology, Inc.
552 S. Washington, Ste. 108
Naperville, IL 60540
800-421-7241
708-369-6060
Fax: 708-983-5967
Key Personnel: George C. Stockin Jr., Pres.
Product Categories: G

Lock-Tight
454 Las Galinas Ave., Suite 132
San Raphael, CA 94903
415-492-0527
Fax: 415-472-6134
Key Personnel: Andy Foster, Jeff Gibbs, Tech. Dir., Nancy Burroughs, Sales Mgr.
Product Categories: A E

Lockinbar, Inc.
753 Oak Grove Rd./ P.O. Box 1216
Medford, OR 97501
800-661-0621
Key Personnel: Craig Adams, Exec. VP

Lockmounts
306 Fall Lick Rd.
Lancaster, KY 40444-9756
606-792-6526
Fax: 606-792-6526
Key Personnel: Allan Halverson
Product Categories: C G

Locknetics Security Engineering
575 Birch St.
Forestville, CT 06010
203-584-9158
Fax: 203-584-2136
Key Personnel: James Scott, Pres.,
George R. Nortonen, VP Mktg. &
Sales
Product Categories: E

Lockplus Software
90 Montreal Rd.
Vanier, Ont., Canada K1L 6E6
613-745-5096
Fax: 613-749-8538
Key Personnel: Dan Boulterice

Locksoft, Inc.
P.O. Box 129
Hastings, NE 68902-0129
402-461-4149
Fax: 402-461-4359
E Mail: compuserve 71165,3426
Key Personnel: Adam L. Blum,
President, Billy B. Edward, Jr., CML,
Vice President, Dorothy G. Friend,
CML, General Manager
Product Categories: D G
See ad on page 54

Lok-Itt Company
27000 Richmond Rd.
Solon, OH 44139
800-735-0131
216-349-0110
Fax: 216-349-2447
Key Personnel: Lloyd Woods, Hugh J.
Webster, Pres., Cham Kahari, Dir.
Sales & Mktg.
Product Categories: F

Lok-Safe Security Products
5373 NW 36th St., P.O. Box
660528
Miami Springs, FL 33166
800-257-4196
305-884-2443
Fax: 305-885-8800
Key Personnel: Jack Lucey, Pres., Mary
Lucey, VP, Arnold Meyer, Plant Mgr.
Product Categories: F

Lori Lock
384 Old Turnpike Rd., P.O. Box 1040
Southington, CT 06489
203-621-3605
Fax: 203-621-5972
Key Personnel: Andy Meade, Pres., Al
Meade, VP Sales & Mktg.
Product Categories: F

Lucky Line Products, Inc.
7890 Dunbrook Rd.
San Diego, CA 92126
800-654-6409
619-549-6699
Fax: 800-334-9709
Key Personnel: Greg Howard, VP
Operations, Brent Howard, VP Sales &
Mktg.

Lund Equipment
2400 N. Cleveland-Masillon Rd.,
P.O. Box 213
Bath, OH 44210

Product Category Key

- A — Alarms
- B — Architectural Hardware
- C — Training Manuals & Materials
- D — Locksmith Software
- E — Electronic Security Products
- F — Locking Products
- G — Locksmith Tools & Equipment
- H — Safes & Safe Products

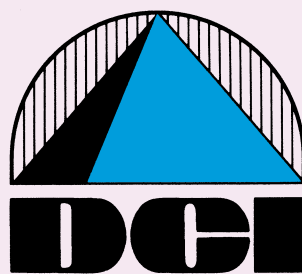

Don't panic!

We have Security Exit Devices.

[Click here for more information](#)

MANUFACTURERS

216-659-4800
Fax: 216-659-9347
Key Personnel: E. Howard Lund, John Skeel, VP, Ray Smiley, Sup.
Product Categories: H

M.A.G. Eng. & Mfg. Inc.
15261 Transistor Ln.
Huntington Beach, CA 92649
800-624-9942
714-891-5100
Fax: 714-892-6845
Key Personnel: Howard M. Allenbaugh, Pres., Fred F. Pannebaker, VP Sales & Mktg., Dennis Ballam, Nat'l. Sales Mgr.
Product Categories: B F

MACE Security International
160 Benmont Ave.
Bennington, VT 05201
800-255-2634
802-447-1503
Fax: 800-545-6223
Key Personnel: Jon Goodrich, Pres., Ron Perrott, Nat'l. Sales Mgr.
Product Categories: A C E

Macro Media Systems, Inc.
407 D.W. Highway
Marrimack, NH 03054
603-424-2674
Fax: 603-429-0783
Key Personnel: Lloyd Tate, Tom Nulling
Product Categories: A E

Magi-Corp Inc.
P.O. Box 627
Vernon, CT 06066
203-872-4222
Fax: 203-872-4600
Key Personnel: Roger Coulombe

Magnokrom, Inc.
171 Nugget Ave.
Scarborough, Ont., Canada M1S 3B1
416-299-0000
Fax: 416-299-3728
Key Personnel: Edward Milic, Pres., B. Johnson, Purchasing
Product Categories: B F

Majestic Lock
194 Daniel St.
Hackensack, NJ 07601
201-343-7728
Key Personnel: Stephanie MacFarlane

Major Manufacturing, Inc.
P.O. Box 788
Atwood, CA 92601
714-772-5202
Fax: 714-772-2302
Key Personnel: Bill DeForrest, John King
Product Categories: F G
See ad on page 77

Major Metallfab Inc. (MMF)
370 Alice St.
Wheeling, IL 60090-5891
800-445-8293
708-537-7890
Fax: 708-537-1120
Key Personnel: Val Burlini, Pres., Rob Fosness, VP Sales, Peter Lindley, Dir. Sales
Product Categories: B F G

Mancini Safe Company
15 Rufo Rd.
Cambridge, MA 02141
800-367-3453
617-497-7233
Fax: 617-497-7542
Key Personnel: Robert Mancini, President, Derek Costa, Wholesale National, Peter Murphy, Svc. Mgr.
Product Categories: H

Markar Products, Inc.
68 Ward Rd.
Lancaster, NY 14086
800-866-1688
716-685-4104
Fax: 716-685-3919
Key Personnel: Stan Tatara AHC-Pres., Tom Frys, VP, Kevin Hamilton, Nat'l. Sales Mgr.
Product Categories: B C

Marketplace International Inc.
P. O. Box 359
Tenafly, NJ 07670-0359
201-384-8289
Fax: 201-384-8289
Key Personnel: Bill Libbett

MARKS U.S.A.
5300 New Horizons Blvd.
Amityville, NY 11701
800-526-0233
516-225-5400
Fax: 516-225-6136
Key Personnel: George Marks, Pres., Evan Marks, VP Production, Ed Poole, Nat'l. Sales Mgr.
Product Categories: B F

Marlee Electronics, Corp.
2501 S. Front St.
Philadelphia, PA 19148-4182
800-874-8036
215-463-4842
Fax: 215-755-7877
Key Personnel: B. Scott Holloway, Pres., Chas Tevis, Oper. Mgr.
Product Categories: E

Marlok Company
1890 Dean St.
St. Charles, IL 60174
708-513-1070
Fax: 708-513-0120

Marshall Electronics
P.O. Box 2027, 5649 Mesmer Ave.
Culver City, CA 90230
310-390-8608
Fax: 310-391-8926
Key Personnel: Kenneth Joyce
Product Categories: E

Mas Hamilton Group, Inc.
805-D Newtown Circle
Lexington, KY 40511
800-950-4744
606-253-4744
Fax: 606-253-4748
Key Personnel: J.D. Hamilton, Pres.
Product Categories: E F

Master Lock Company
2600 North 32nd Street
Milwaukee, WI 53201
414-444-2800
Fax: 414-449-3162
Key Personnel: Jim Donegan, Executive VP, Sales & Marketing, Steve Williams, VP, Marketing, Todd Neimuth, Product Manager
Product Categories: B F

Maxfort Corporation
1358 Vineland Ave.
Baldwin Park, CA 91706
818-813-9800
Fax: 818-813-0637
Key Personnel: Sy-Bor-Ma, GM, Johnny Ong, Operation Mgr.
Product Categories: F

Maxim Technologies Inc.
3044 Albany Crescent, Ste. 5G
Bronx, NY 10463
718-548-9219
Fax: 718-548-9219
Key Personnel: J.K. Lapham, Timothy Ryan, VP, Joan Moriarty, Office Mgr.
Product Categories: B F

Maxton Security Systems
3935 Oakfield Dr.
Sherman Oaks, CA 91423
818-788-4466
Key Personnel: Anthony B. Bennett, Pres.
Product Categories: F

MBI Business Software
5249 Galaxy Parkway
Sacramento, CA 95823-2123
800-551-4624
916-444-2922
Fax: 916-393-0930
Key Personnel: Danna A. Munley, Pres., Done' J. Biasi, VP Devel.
Product Categories: D

McDowell-Craig
13146 Firestone Blvd.
Norwalk, CA 90650

310-921-4441
Fax: 310-921-6084
Key Personnel: Steven Craig

McGunn Safe Co.
4917 S. Central Ave.
Chicago, IL 60638
800-621-2816
708-458-7233
Fax: 708-458-3323
Key Personnel: Patricia S. Johnson-McGunn, Pres., Ed McGunn, Chairman, April L. Locke, VP
Product Categories: E H
See ad on page 167

MDS (Medical Diagnostics Services Inc.)
511 N. Limona Rd.
Brandon, FL 33510
800-435-9352
816-653-1180
Fax: 816-684-5953
Key Personnel: Paul Butler, Pres., Trudi R. Battle, VP
Product Categories: G

Medeco Security Locks, Inc.
P.O. Box 3075
Salem, VA 24153
800-548-8472
703-380-5000
Fax: 703-380-5010
Key Personnel: Tim Layton, VP, Joey Dalessio, VP Sales, Len Blackwell, VP Mktg.
Product Categories: C E F

Megan Marie Creations, Inc.
3203 W. Mequon Rd.
Mequon, WI 53092
800-4-KEY KIT
414-242-7739
Fax: 414-242-1745
Key Personnel: Richard T. Paetz, Pres., Karen Paetz, VP Oper., Megan Marie Paetz, VP Mktg.
Product Categories: F G

Meilink Safe Co.
111 Security Parkway
New Albany, IN 47150
800-634-5465
812-941-0024
Fax: 800-896-6606
Key Personnel: Van Carlisle, Pres. & CEO, Judd Penske, Nat'l. Sales Mgr., Dennis Lindsey, Sales Mgr.
Product Categories: H

Meister Atlanta Corp.
3673 Clairmont Rd.
Atlanta, GA 30341
404-451-9700
Fax: 404-451-5305
Key Personnel: Renate Dellefs
Product Categories: F

Merit Metal Products Corp.
242 Valley Rd.
Warrington, PA 18976
215-343-2500
Fax: 215-343-4839
Key Personnel: Daryl T. Schaefer, Sales Mgr., Adam Stefanowicz, GM, Don Mully, Sales
Product Categories: B

Milwaukee Electric Tool Corporation
13135 West Lisbon Rd.
Brookfield, WI 53005
414-781-3600
Fax: 414-781-3611
Key Personnel: Debra Sajkowski, Adv. Mgr.
Product Categories: G

Mini-Vaults
15339 Pipeline Lane
Huntington Beach, CA 92649
800-892-6275
714-892-1040
Fax: 714-572-9238
Key Personnel: Bob Lichter, Pres.
Product Categories: H

MIWA Lock, Canada
Box 3708 Station 'D'
Edmonton, AB, Canada T5L 4J7
403-453-5226

Fax: 403-452-7551
Key Personnel: Gary J. Mozak, Sales Mgr.
Product Categories: B F

MIWA Lock, USA
71 N. Pecos Rd., Ste. 106
Las Vegas, NV 89101
800-397-4631
702-452-4110
Fax: 702-452-9330
Key Personnel: Will Schoff, Pres., Pete Wilson, Sales Mgr., Robert Schaff, Oper. Mgr.
Product Categories: F

Mnemonics, Inc.
102 Gaither Dr.
Mt. Laurel, NJ 08054
609-234-0970
Fax: 609-234-6793
Key Personnel: Jim Nichols
Product Categories: E

Moore Software Development (MSD)
1059 Dulin Drive
Amissville, VA 22002
703-349-1120
Fax: 703-349-1538
Key Personnel: Randy Moore, Owner
Product Categories: C D

Monarch Tool and Mfg. Co., Inc.
105 East Fourth St.
Covington, KY 41011
800-462-9460
606-261-4421
Fax: 606-261-7403
Key Personnel: Stephanie Hall, Pres., Pete Bigner, VP, Norman Martin, Corp. Admin.
Product Categories: F

Morse Watchmans Inc.
2 Morse Rd.
Oxford, CT 06478
800-423-8256
203-264-4949
Fax: 203-264-8367
Key Personnel: Manuel Pires, Pres., Fernando Pires, VP
Product Categories: E
See ad on page 83

Mosler
1561 Grand Blvd.
Hamilton, OH 45012
800-543-4584
513-867-4062
Fax: 513-870-1071
Key Personnel: Ruth Jacobs, Mgr. Mktg. Comm.
Product Categories: A E F H

Mr. Wrought Iron Canada Ltd.
1100-11 St. SE
Calgary, AB, Canada T2G 4T3
403-234-9690
Key Personnel: Michael Morozoff, Pres.

MRL, Inc.
7640 Fullerton Rd.
Springfield, VA 22153
800-989-9891
703-569-0195
Fax: 703-569-0196
Key Personnel: Carleton Moorefield Jr., Pres.
Product Categories: E F

Mul-T-Lock USA Inc.
300-1 Route 17 South, Suite A
Lodi, NJ 07644
800-562-3511
201-778-3222
Fax: 201-778-4007
Key Personnel: Joe Levy, President, Michael Pennachio, Sales & Marketing
Product Categories: C D F G H

Multi Lock Inc.
P.O. Box 70277
Ft. Lauderdale, FL 33307-0277
305-563-2148
Fax: 305-563-5644
Key Personnel: M.E. De Palma, VP, Clarence Fulton, Plt. Mgr.
Product Categories: F
See ad on page 55

Multi-Lock Corporation

1500 West Seltice Way
Post Falls, ID 83854
800-354-3284 x6543
208-777-6543
Fax: 208-777-6402
Key Personnel: Shon L. Davis, Cust.
Svc. Rep., Brian Kleinjans, Dir. Mktg.
Sales Oper.
Product Categories: F
See ad on page 117

Mutual Safe Co.
733 NW Bypass
Springfield, MO 65802
800-443-0731
417-869-2242
Fax: 417-869-2625
Key Personnel: Aron Green, Pres.,
Rowan Green, Dir., Maureen Long,
Mgr.
Product Categories: H

Nanotechnology, Inc.
22997 Standing Oak Ct.
Cupertino, CA 95014-2660
408-973-8280
Fax: 408-973-8280
Key Personnel: John Chu, Pres., Ann
Woo, Mktg. Mgr.
Product Categories: E

National Cabinet Lock
200 Old Mill Rd., P.O. Box 200
Mauldin, SC 29662
803-297-6655
Fax: 803-297-9987
Key Personnel: Dave Bowers, Pres.,
Scott James, VP Sales & Mktg., Larry
Roddy, Nat'l. Sales Mgr.
Product Categories: F

National Door Controls
P.O. Box 2502
Durham, NC 27715
800-231-0402
Fax: 919-220-6084
Key Personnel: Robert Hales

National Electronics
3030 River Rd.
River Grove, IL 60171
800-722-2288
708-452-3400
Fax: 708-452-3450
Key Personnel: Steve Nesbitt, Dir.
Nat'l. Acct., Christine Vaz, Dir. Mktg.,
Flint Cooper, Exec. VP & GM
Product Categories: E

National Guard Products, Inc.
540 North Parkway
Memphis, TN 38105
800-647-7874
Fax: 800-255-7874
Key Personnel: Neal Frazier, Nancie
Carter, Helen Rose
Product Categories: B

National Mfg. Co.
1 First Ave.
Sterling, IL 61081
815-625-1320
Fax: 815-625-1333
Key Personnel: Greg Yemm

National Safe Company, Inc. (NSCI)
7 Lipson Ct. #100
E. Northport, NY 11731-3447
516-368-2000
Fax: 516-368-2008
Key Personnel: Ralph P. Nussbaum,
Pres.

National Security Safe Co.
620 South 380 East
American Fork, UT 84003
800-544-3829
801-756-7706
Fax: 801-756-8043
Key Personnel: Glen Nilson, Pres.,
Dave Farmer, VP, Steve Frandsen,
Asst. VP
Product Categories: H

Nel-Tech
2515 E. Michigan Blvd.
Michigan City, IN 46360
800-874-2050
219-874-7500

Fax: 219-874-9990
Key Personnel: James Alinsky, GM
Product Categories: E

New England Lock & Hardware Co.
46 Chestnut St.
S. Norwalk, CT 06854
203-866-9283
Fax: 203-838-4837
Key Personnel: James W. Egan,
President
Product Categories: F

New Standard Mfg. Co.
2408 Western Ave.
Las Vegas, NV 89102
702-385-1132
Fax: 702-385-2615
Key Personnel: Randy L. Thwing, Pres.,
Kathalynn F. Thwing, Sec., Treas.
Product Categories: F

NKL Industries, Ltd., NKL Safe Co.
1111 Cavalier Blvd.
Chesapeake, VA 23323
800-528-9900
804-485-0200
Fax: 804-485-0271
Key Personnel: Mike Smith, Pres., Pam
Cummings, Tech. Supp., Ray Lorenzo,
CEO
Product Categories: E H

Norden Lock Co., Inc.
361 Carlough Rd.
Bohemia, NY 11716
800-233-5625
516-563-0900
Fax: 516-563-1742
Key Personnel: H. Peter Norden, Jr,
Pres.
Product Categories: B F

Northeast Lock Corp.

48 Oak St.
Clifton, NJ 07014
800-524-2575
201-777-7509
Fax: 800-524-2576
Key Personnel: George Polke, Pres.,
Kim Palmer, Sales, Kevin McCallen,
Sales
Product Categories: F
See ad on page 110

Northern Computers, Inc.
5007 S. Howell Ave.
Milwaukee, WI 53207
800-323-4576
414-769-5980
Fax: 414-769-5989

Key Personnel: Joel Konicek, Pres.,
Dave James, VP, Jim Vinson, Dir. Sales
& Mktg.
Product Categories: E

Norton®, Div. Yale Security Inc.
P.O. Box 25288
Charlotte, NC 28229-8010
704-283-2101
Key Personnel:

NT Falcon Lock
2650 Orbiter St.
Brea, CA 92621-6265
800-266-4456
714-572-6008
Fax: 800-777-8229

Key Personnel: E.F. Johnson, Pres.,
Don Johnson, Nat'l. Sales Mgr., Dave
Carter, East. Reg. Mgr.

NT Monarch Hardware & Mfg. Co.
805 N. Buckman St., P.O. Box 548
Shepherdsville, KY 40165
800-826-5792
502-543-2281
Fax: 502-543-3089
Key Personnel: W.G. Porter, Pres.
Robert C. Johnson AHC, GM Robert
McGehee, Cust. Svc. Mgr.
Product Categories: B E

NT Quality Hardware Mfg.
2650 Orbiter St.
Brea, CA 92621-6265
800-345-8819
714-572-1011
Fax: 800-345-8820
Key Personnel: Ed Johnson, Pres., Don

Johnson, Nat'l. Sales Mgr., Dave
Carter, East. Reg. Mgr.
Product Categories: B

Numberall Stamp & Tool Co., Inc.

P.O. Box 187 High St.
Sangerville, ME 04479
207-876-3541
Fax: 207-876-3566
E Mail: office @ numberall.win.net
Key personnel: Rick Pellerin, Sales
Mgr.
Product Categories: G
See ad on page 58

O-Mega
3544 Overland Ave.
Los Angeles, CA 90034
800-553-0222
310-837-0963
Fax: 310-837-0942
Key Personnel: Zane Rothschild, CEO
Product Categories: A E

OEM Mfg. Inc.
194 Daniel St.
Hackensack, NJ 07601
800-243-8636
201-489-2184
Fax: 201-343-7315
Key Personnel: Wes Zion, Pres.,
Stephanie McFarlane, Off. Mgr., Jeff
Zion, VP
Product Categories: F G

Olympus America Inc.-IFD
Two Corporate Center Drive
Melville, NY 11747-3157
800-446-5620
516-844-5000
Fax: 516-844-5620
Peter Lorenz, Director of Sales &
Marketing, James Costello, Marketing
Manager, Steve Sarich, National
Sales Manager
Product Categories: G

Olympus Lock
8512 20th Ave. NE
Seattle, WA 98115
800-525-0954
206-525-5338
Fax: 206-523-9876
Key Personnel: Jerry Martin, VP, Beth
Nielsen, Mktg. Mgr., Dianna
Simmonds, Bus. Dev. Mgr.
Product Categories: F

Omnia Industries, Inc.
P.O. Box 330
Cedar Grove, NJ 07009-0330
201-239-7272
Fax: 201-239-5960
Key Personnel: Alberto R. Comini,
Pres., Denyse Comini Becker, Exec.
VP, John L. Barwick, National Sales
Mgr.
Product Categories: B F

Optex Inc. (HBA Division)
20501 Earl St., Suite 3
Torrance, CA 90503
800-966-7839
310-214-2389
Fax: 310-214-0131
Key Personnel: Dennis Olson, Pres.,
Rob Blair, Dir. HBA Div., Ned
Morioka, Nat'l. Sales Mgr.
Product Categories: E

OSI Security Devices
657 North Pastoria Ave.
Sunnyvale, CA 94086
408-720-0909
Fax: 408-720-9034
Key Personnel: Ron Perkins, Nat'l.
Sales Mgr., Alan Weiland, VP
Product Categories: E
See ad on page 17

Pach & Company
941 Calle Negocio
San Clemente, CA 92672
714-498-2951
Fax: 714-498-6879
Key Personnel: John Camp, Nat'l.
Sales Mgr.
Product Categories: E
See ad on page 43

Pacific Scientific Motor Products Div.

4301 Kishwaukee St.
Rockford, IL 61109
815-226-3100
Fax: 815-226-3148
Key Personnel: Ronald Nelson, Pres.
See ad on page 72

Pacific Security Products Co.

307 S. Raymond Ave.
Alhambra, CA 91803
800-331-0785
818-570-4655
Fax: 818-289-2326
Key Personnel: Jae Chang, Owner,
Denise Ambrose
Product Categories: H
See ad on page 83

Pado Security Inc.
7010 Washington Ave.
New Orleans, LA 70125
800-523-9877
504-482-5318
Fax: 504-486-6509
Key Personnel: William Winterfeld,
Pres., V. Dewey Ricks, Dir. Sales &
Mktg.
Product Categories: F G

Paktek, Inc.
7307 82nd St. Ct. SW
Tacoma, WA 98498
800-258-8458
206-584-4914
Fax: 206-589-1091
E Mail: alan at prostar. comm.
Key Personnel: Mark Blanchard, Pres.,
Alan Billingsley, CEO, Steve Tucker,
Sales
Product Categories: G

Palmer Security Products, Inc.
2930 N. Campbell Ave.
Chicago, IL 60618
800-788-7725
312-267-3475
Fax: 312-267-8080
Key Personnel: Chuck Wisler, Robert
Wagner, Mgr. Cust. Svc.
Product Categories: H

Panasonic Broadcast & Television Sys.
Co.
One Panasonic Way
Secaucus, NJ 07094
201-392-4429
Fax: 201-348-7372
Key Personnel: Milton Landau, Group
General Manager Frank Abram, Asst.
General Manager Robert Schindler,
Marketing & Sales Admin. Mgr.
Product Categories: E

Panef
5700 W. Douglas Ave.
Milwaukee, WI 53218
800-448-1247
414-464-7200
Fax: 414-462-0980
Key Personnel: Linda J. Hartley,
George Walker, Chairman, Bruce
Ketchpaw, Pres.
Product Categories: G

PCSC
18528 Dominguez Hills Drive
Rancho Dominguez, CA 90220-6415
310-638-0400
Fax: 310-638-6204
Key Personnel: Craig Rose
PDQ Industries
2754 Creek Hill Rd.
Leola, PA 17540
800-441-9692
717-656-4281

Product Category Key

- A — Alarms
- B — Architectural Hardware
- C — Training Manuals & Materials
- D — Locksmith Software
- E — Electronic Security Products
- F — Locking Products
- G — Locksmith Tools & Equipment
- H — Safes & Safe Products

Fax: 717-656-6892
Key Personnel: Bill Tell, Pres., Bill Amman, Nat'l. Sales Mgr.
Product Categories: B F

Pelco
300 W. Pontiac Way
Clovis, CA 93612-5699
800-289-9100
209-292-1981
Fax: 209-292-3827 or 800-289-9150
Key Personnel: David L. McDonald, Pres., Thomas H. Grogan, Sr. VP Sales & Mktg., Carrie Migliore, VP Finance
Product Categories: E
PEMCO Inc.
4226 Transport St.

Ventura, CA 93003
800-283-9988
805-642-2600
Fax: 805-642-4109
Key Personnel: Charlie Kops, Nat'l. Sales Mgr., Mike Eckles., Mark Page, Commercial Prod. Mgr.
Product Categories: B F

Pentax Corporation/Cosmicar Lens Division
35 Inverness Drive East
Englewood, CO 80112
303-799-8000
Fax: 303-643-0226
Key Personnel: Warren Wright, National Sales & Mktg. Mgr., Kenny Okochl, Sales Administrator
Product Categories: E

Period Brass
117 Foote Ave.
Jamestown, NY 14702-0520
800-332-6677
Fax: 800-215-8837
Key Personnel: Roby T. Briggs, VP Sales & Mktg.
Product Categories: B

Perma-Vault Safe Corporation
P.O. Box 473
Huntingdon Valley, PA 19006
215-938-4300
Fax: 215-938-4310
Key Personnel: Marvin Sobel, President, Irv Plaksin, VP, Laurie Muehlbach, Mktg. Mgr.
Product Categories: H
See ad on page 64

Perry Blackburne, Inc.
354 Pine St.
Pawtucket, RI 02860
800-556-7474
401-725-1400
Fax: 401-725-7611
Key Personnel: Mark Rosenberg, VP Sales & Mktg., Perry Mermelstein, Pres., Edward Paul, Exec. VP
Product Categories: F

Personal Safety Corp.
1905 N. Center Point Rd. / P.O. Box 128
Hiawatha, IA 52233
319-378-8787
Fax: 319-378-1311
Key Personnel: Thomas R. Leidigh, Pres.

Phoenix Industries Inc.
32 Hwy. East
Linwood, KS 66052
800-238-3203
913-723-3203
Fax: 913-723-3507
Key Personnel: Jeff Coatney, Sharon A. Coatney, Sec. Treas.
Product Categories: A B E F
See ad on page 105

Positive Lock, Inc.
402 E. 39th St.
Russellville, AR 72801
800-342-7670
501-967-6232
Fax: 800-531-5293
Key Personnel: Phillip J. Murders, Pres.
Product Categories: A B F

Power Access Corporation
106 Powder Mill Rd.
Collinsville, CT 06022
800-344-0088
203-693-0751
Fax: 203-693-0641
Key Personnel: Nils Sellman, Pres., Robert A. Swenson, Nat'l. Sales Mgr.
Product Categories: E F

PowerStar Products, Inc.
1050 East Duane Ave., Suite D
Sunnyvale, CA 94086
408-774-6800
Fax: 408-774-6818
Key Personnel: D. Scott McFadin, President, Francis Phillips, Sales Manager
Product Categories: G

Precision Hardware
38100 Jaykay Dr.
Romulus, MI 48174
313-326-7500
Fax: 313-326-7540
Key Personnel: Scott McIntire
Product Categories: B E F

Preso-Matic Keyless Locks
237 Coastline Rd.
Sanford, FL 32771-6659
407-324-9933
Fax: 407-328-9977
Key Personnel: Bob Campbell, VP Sales, Grant Campbell, VP, Doug Van Dee, Prod. Mgr.
Product Categories: F
See ad on page 74

Prestolock by CCL Security Products
199 Whiting St.
New Britain, CT 06051-4360
800-216-0082
203-229-6199
Fax: 203-223-7601
Key Personnel: Kevin Jacob, Dir. Sales & Mktg., Jim Stafstrom, Sales Mgr.
Hardware, David Barzottini, Sales Mgr. Luggage
Product Categories: F

Pride Barco Lock Company
116 North Nopal St., Ste. 4
Santa Barbara, CA 93103-3334
800-578-1816
805-965-8819
Fax: 805-965-2535
Key Personnel: Armand J. Renga, Pres., Kym Renga, Sales
Product Categories: B F H



***SRI and Tech Train
Productions are the
automotive specialists -
your best source for
automotive tools,
manuals, and videos.***

[Click here for more information](#)

Prime Line Products Co.
4185 Hallmark Pkwy,
San Bernardino, CA 92407
800-255-3505
909-887-8118
Fax: 909-880-8968
Key Personnel: Ken Dahlgren, Nat'l.
Sales Mgr., Tony Al-Rawi, Sales
Coord., Dick Ugland, Dir. Sales &
Mktg.
Product Categories: F

Pro-Lok
1060 N. Batavia
Orange, CA 92667
714-633-0681
Fax: 714-633-0470
Key Personnel: Adam Weinraub,
Pres., Tom Gillespie, VP Sales & Mktg.
Product Categories: C G

Proprietary Control Systems
Corp.(PCSC)
18528 Dominguez Hills Dr.
Rancho Dominguez, CA 90220-6436
310-638-0400
Fax: 310-638-6204
Key Personnel: Craig Rose, Nat'l.
Sales Mgr., Masami Kosaka, Pres.,
Robert Takahashi, VP Finance &
Admin.
Product Categories: E

Qualtec Data Products, Inc.
47767 Warm Springs Blvd.
Fremont, CA 94539
800-628-4413 outside CA
510-490-8911
Fax: 510-490-8471
Key Personnel: Gary Torres, VP Sales
Product Categories: F

R&D Tool Co.
7705 R.C. Gorman Ave. NE
Albuquerque, NM 87122-2774
505-828-2664
Fax: 505-857-0642
Key Personnel: Douglas Joosten, RL
Pres., Ruth A. Joosten, VP
Product Categories: G

R.J. Stuckel Co., Inc.
1385 Howard St.
Elk Grove, IL 60007
800-789-7220
708-593-7220
Fax: 708-593-6027
Key Personnel: Robert W. Stuckel,
Pres.
Product Categories: G

R.R. Brink Locking Systems Inc.
500 Earl Rd.
Shorewood, IL 60436
815-744-7000
Fax: 815-744-7020
Key Personnel: Robert R. Brink, Charles
R. Brink, Sales, Eng. Mktg. Mgr.,
Stephen J. Fox, Cust. Svc. Mgr.
Product Categories: B E

Radionics
1800 Abbott St.
Salinas, CA 93901
800-538-5807
408-757-8877
Fax: 408-757-2438
Key Personnel: Stephen Rogers, Prd.
Mktg. Mgr. Acc. Ctrl., Roger
Leadabrand, Nat'l. Sales Dir.
Product Categories: A E

Radolph-Desco Co., Inc.
580 Sylvan Ave., P.O. Box 1245
Englewood Cliffs, NJ 07632
Key Personnel: Michael Simon

RB Enterprises
42654 Deep Forest Dr.
Coarsegold, CA 93614
800-452-5276
209-642-2710
Fax: 209-642-2699
Key Personnel: Robert Barr, Owner
Product Categories: A

Reading Body Works
P.O. Box 650
Shillington, PA 19607
800-458-2226

610-775-3301
Fax: 610-775-3261
Key Personnel: Jack O'Donnell, VP
Sales
Product Categories: G

Reilor Inc.
417 Caredean Dr.
Horsham, PA 19044
800-521-5294
215-956-0550
Fax: 215-956-0553
Key Personnel: Richard Charney,
GM/VP, T. Scott Asay, Sales Mgr.
Product Categories: B

Reliable Lock
10 Bent Birch Place
Parsippany, NJ 07054
201-674-7667
Key Personnel: Joe Pannucci

Richardson Electronics, Ltd.
600 N. Shepherd Dr., Ste. 113
Houston, TX 77007

713-973-6292
Key Personnel: Christine Vaz

Ridgewood House
P.O. Box 198
Middle Village, NY 11379
718-894-3321
Fax: 718-894-2674
Key Personnel: Norbert Langsam, VP
Product Categories: E G

Rixson-Firemark, Sub. of Yale Sec. Inc.
9100 W. Belmont Ave.
Franklin Park, IL 60131
708-671-5670
Key Personnel: Robert C. Johnson, Gen
Sales Mgr.

Rodann Electronics Mfg. Co.
3100 Airway Ave., Suite #128
Costa Mesa, CA 92626
714-662-3232
Fax: 714-662-3171
Key Personnel: Alex Skarbek, Pres.

Rofu International Corp.
2004B 48th Ave. Ct. E
Tacoma, WA 98424
800-255-ROFU
206-922-1828
Fax: 206-922-1728
Key Personnel: Len Guyt, Pres., Jon
Snyder, Mktg. Mgr., Julie Collins,
Office Mgr.
Product Categories: B E

Product Category Key

- A — Alarms
- B — Architectural Hardware
- C — Training Manuals & Materials
- D — Locksmith Software
- E — Electronic Security Products
- F — Locking Products
- G — Locksmith Tools & Equipment
- H — Safes & Safe Products

NATIONAL

AUTO LOCK SERVICE, INC.

National Auto Lock Service, Inc.
offers a wide range of equipment
and services for the Automotive
Locksmith. From tools and hard to
find key blanks to transponder
programming, we can take the
mystery out of car service. We
accept credit card orders, and
can ship COD. Contact us for the
latest in automotive technology.

Rokonet Industries USA
5 Westchester Plaza
Elmsford, NY 10523
800-344-2025
914-592-1068
Fax: 914-592-1271
Key Personnel: Sam Karas, VP Mktg.
Sales, Glenn Tompkins, Sr., Nat'l.
Sales Mgr.
Product Categories: A

Rothley Brass
P.O. Box 429, 501 Railroad St.
Taylorsville, KY 40071
Key Personnel: Tom Jennings, Pres.

Rudolph-Desco Company, Inc.
580 Sylvan Ave.
Englewood Cliffs, NJ 07632
201-568-4920
Fax: 201-568-0971
Key Personnel: Michael H. Simond, VP
Product Categories: B D

Rutherford Controls, Inc.
2697 International Pkwy., Bldg. #3-
122
Virginia Beach, VA 23452
800-899-5625
804-427-1230
Fax: 804-427-9549
Key Personnel: John S. Rutherford,
Pres., Tracey L. Rutherford, VP
Operations, David G. Halls, VP Sales
Product Categories: E F

Rylan, Inc.
2908 Oregon Ct. I-5
Torrance, CA 90503
800-447-9826
310-328-6553
Fax: 310-212-6002
Key Personnel: Mike Sopko, Pres.,
Marilyn Detloff, Cust. Svc., Sam
Sopko, Tech. Supp.
Product Categories: G

S. Parker Hardware Mfg. Corp.
Parker Dr., P.O. Box 9882
Englewood, NJ 07631
800-S-PARKER
201-569-1600
Fax: 201-569-1082
Key Personnel: Chas. Silberman, Pres.,
Bob Schaeffer, Senior VP, Robert
Hand, VP
Product Categories: B F

Safe Corporation International
P. O. Box 1451
Englewood, CO 80150-1451
303-781-1413
Key Personnel: Brian Hambleton, Pres.

Safe-Gard Security Prod. Ltd.
#527-7620 Elbow Dr.
Calgary, AB, Canada T2V 1K2
403-258-2588
Fax: 403-640-4215
Key Personnel: Maurice Benson
Product Categories: F G

Safe-O-Mat Coin Locks
4408 Dunham Dr.
Edina, MN 55435
612-927-6103
Fax: 800-733-7139
Key Personnel: George Lundegard,
Sales Mgr.
Product Categories: F

Safety One Inc.
23200 Chagrin Blvd., Ste. 600
Beachwood, OH 44122
800-567-9765
Key Personnel: J. Rozgonyi, VP, D.
Nisman, Pres.
Product Categories: A C E

Safety Technology International, Inc.
2306 Airport Rd.
Waterford, MI 48327
800-888-4784
810-673-9898
Fax: 810-673-1246
Key Personnel: Mike Mikgelian, Sales
Mgr., Jack Taylor, Pres., Lori Lynn
Taylor, VP Sales & Mktg.
Product Categories: A E

Salsbury Industries
1010 E. 62nd St.
Los Angeles, CA 90001-1598
800-323-3003
213-232-6181
Fax: 213-232-7021
Key Personnel: Dennis Fraher, Brian
Fraher, Dir. Mktg.
Product Categories: F
See ad on page 52

Samsung OPTO - Electronics America
Inc.
40 Seaview Dr.
Secaucus, NJ 07094-1807
800-762-7746
201-902-0347
Fax: 201-902-9342
Key Personnel: Peter Sandin, National
Sales Manager, Cathy Zimmerman,
Sales Coord.
Product Categories: E

Sandstrom Products Co.
224 Main St.
Port Byron, IL 61275
800-747-1084
309-523-2121
Fax: 309-523-3912
Key Personnel: Rick J. Hartssock, Pres.,
Brian Suhl, Sales, Nigel Robins, Sales
Mgr.
Product Categories: F
See ad on page 185

Sargent & Greenleaf, Inc.
One Security Dr.
Nicholasville, KY 40356
606-885-9411
Fax: 606-885-3063
Key Personnel: Jerry Morgan, Pres.,
Grant Hart, Nat'l. Sales Mgr., Gary
Kepler, Mktg. Mgr.
Product Categories: E F

Sargent Manufacturing Co.
55 Long Wharf Dr.
New Haven, CT 06511
203-624-5225
Fax: 203-777-9042

Schlage Lock Co.
2401 Bayshore Blvd.
San Francisco, CA 94134
415-467-1100
Fax: 415-330-5626
Key Personnel: Martin Burkhardt
See ad on page 193

Schwab Corp.
3000 Main St.
Lafayette, IN 47903-5085
800-428-7678
317-447-9470
Fax: 317-447-8278
Key Personnel: Jeff McQueen, VP
Sales & Mktg., Bill Woodward, Tech.
Svc., Penny Golden, Cust. Svc. Supp.
Product Categories: H

SeKure Controls, Inc.
3714 Runge Rd.
Franklin Park, IL 60131
800-322-2435
708-288-1111
Fax: 708-288-9999
Key Personnel: Roger Leyden, Pres.,
Peter Passuntino, VP Oper.
Product Categories: E

Sealeze Corp.
8000 White Pine Rd.
Richmond, VA 23237
800-446-7325
804-743-0982
Fax: 800-448-2908
Key Personnel: Olin V. Hyde, Pres.,
James M. Lyman, VP
Product Categories: B

Seco-Larm
17811 Sky Park Circle, Ste. D & E
Irvine, CA 92714
800-662-0800
714-261-2999
Fax: 714-261-7326
Key Personnel: S.M. Hwang, Pres.,
Michael J. Block, VP
Product Categories: A E

Secura Key
20447 Nordhoff St.
Chatsworth, CA 91311
818-882-0020
Fax: 818-882-7052
Key Personnel: Gordon S. Morris, Dir.
Sales & Mktg., Eric Bernocco, Sales
mgr.
Product Categories: E

Secure-It-Inc.
18 Maple Court
E. Longmeadow, MA 01028
800-451-7592
413-525-7039
Fax: 413-525-8807
Key Personnel:
Product Categories: F

Securitech Group, Inc.
54-45 44th St.
Maspeth, NY 11378
800-625-LOCK
718-392-9000
Fax: 718-392-8944
E Mail: securitec@aol.com
Key Personnel: Mark Berger, Pres.,
Perry Conroe, Cust. Svc., Christine
Spooner, Cust. Svc. Mgr.
Product Categories: A B C E F

Securitron Magnalock Corp.
550 Vista Blvd.
Sparks, NV 89434
800-MAG-LOCK
702-355-5625
Fax: 702-355-5636
Key Personnel: Bob Cook, Pres., Vince
Fallicciardi, VP Mktg., Scott Baker,
Nat'l. Sales Mgr.
Product Categories: E F
See ad on page 181

Security Corner
801 N. Main St.
Mansfield, TX 76063-1507
800-683-0696
817-473-1877
Fax: 817-473-8088
Key Personnel: Rick Segerstrom
Product Categories: F G H

Security Door Controls
31280 La Boya Dr.
Westlake Village, CA 91362-4005
818-889-1622
Fax: 800-959-4732
Key Personnel: Rick Geringer, VP, Bill
McGinty, Nat'l. Sales Mgr., Shane
Geringer, Sales
Product Categories: E F

Security Fastener Co.
3854 Industrial Way
Benicia, CA 94510
707-746-8025
Fax: 707-746-0347
Key Personnel: Rich Ross, R.L. Ross,
Mktg.
Product Categories: G

Security Latch
P.O. Box 129, 100 Mission Trail
Cederville, MI 49719
800-633-6622
906-484-3120
Fax: 906-484-2761
Key Personnel: Robert Vanderboegh,
Pres., Jennifer Kostecki, Mktg. Sales
Product Categories: F
See ad on page 14

Select Products Limited
P.O. Box 19584
Kalamazoo, MI 49019-0584
800-423-1174
Fax: 800-423-7107
Key Personnel: Peggy Quinn, GM,
Cheryl Bixby, Cust. Svc., Kevin
Weathers, Admin. Mgr.
Product Categories: B

Sentex Systems, Inc.
20700 Lassen St.
Chatsworth, CA 91311
818-700-9800
Fax: 818-700-5000
Key Personnel: Rick Greenthal
Product Categories: E
See ad on page 59

Sentry Door Lock Guards
P.O. Box 326
Dania, FL 33004
305-922-1600
Key Personnel: Michael W. Dorn,
Pres., Diana Dorn, Sec./Treas.
Product Categories: F

Sentry Group
900 Linden Ave.
Rochester, NY 14625
716-381-4900
Fax: 716-381-8559
Key Personnel: Jim Brush, VP Sales &
Mktg.

Sentry Security Fasteners
P.O. Box 10165
Peoria, IL 61612
309-693-3800
Fax: 309-693-2872
Key Personnel: Tom Ferre, President,
Steve Cramer, Vice President
Product Categories: G

Sentrylok, Inc.
1930 Case Parkway
Twinsburg, OH 44087
216-425-1354
Fax: 216-425-1884
Key Personnel: Scott Kuntz, Pres.,
Robert Fox, VP
Product Categories: A B E F
See ad on page 107

SeQwill Corp.
145 W. Main St.
Barrington, IL 60010
708-381-0730
Fax: 708-381-1676
Key Personnel: John P. Williams, Pres.
Product Categories: E F

Serr-Edge Machine Co.
4471 W. 160th St.
Cleveland, OH 44135
800-443-8097
216-267-6333
Fax: 216-267-2929
Key Personnel: Linda Ribar Oakley,
Pres.
Product Categories: G

Sibes Brass/Iseo Locks
260 Lambert, Ste. K
Oxnard, CA 93030
800-843-4951
805-988-1407
Fax: 805-988-9493
Key Personnel: J. Harvey Landry, Sales
Mgr.
Product Categories: F G

Sieveking Products Co.
P.O. Box 4287
Rockford, IL 61109
815-874-4030
Fax: 815-874-5713
Key Personnel: Bob Sieveking, Owner,
Jane Sieveking, Mgr.
Product Categories: G

Silca Keys U.S.A., Inc.
9049 Dutton Dr.
Twinsburg, OH 44087
800-648-9239
216-487-5454
Fax: 216-487-5459
Key Personnel: Barney Goldberg, VP
Sales & Mktg., Don Mears, W. Coast
Zone Mgr., Bob Mekrvtit, Logisdcs
Mgr.
Product Categories: D G
See ads on pages 109 & 143

Silent Knight Security Systems
7550 Meridian Circle North
Maple Grove, MN 55369-4927
612-493-6400
Fax: 612-493-6475
Key Personnel: Kit Vail, Pres.

Product Category Key

- A — Alarms
- B — Architectural Hardware
- C — Training Manuals & Materials
- D — Locksmith Software
- E — Electronic Security Products
- F — Locking Products
- G — Locksmith Tools & Equipment
- H — Safes & Safe Products

Continued on page 90

Continued from page 88

Simplex Access Controls®
2941 Indian Ave.
Winston-Salem, NC 27105
800-849-8324
910-725-1331
Fax: 910-725-3269
Key Personnel: Thomas E. Nazziola,
VP Mktg., Dick Garofano, Nat'l. Sales
Mgr.
Product Categories: F

Slide Lock Tool Co., Inc.
1166 Topside Rd.
Louisville, TN 37777
800-336-8812
577-8470
Fax: 577-5936
Key Personnel: D. Scott Selby, Elaine
Selby
Product Categories: C G

Slideline, Inc.
4079 Oceanside Blvd., Suite A
Oceanside, CA 92056
800-545-0544
619-945-0544
Fax: 619-945-8359
Key Personnel: David M. Prochaska,
Pres.
Product Categories: F

Solutions Worldwide
14905 93A Avenue
Surrey, BC, Canada V3R 7A8
800-883-9388
604-582-4806
Fax: 604-582-4386
Key Personnel: Steve Pineau, President,
Steve Leach, Vice President
Product Categories: A E

Source of Safety, International
4707 N. High St., P.O. Box 14406
Columbus, OH 43214
800-421-9496
614-421-9494
Fax: 614-421-0008
Key Personnel: Tim Finley, Pres., Larry
M. Daniels, VP
Product Categories: A E F

Southern Cross Development
P.O. Box 7152
Bozeman, MT 59771
406-587-0855
Fax: 406-585-5460
Key Personnel: Mitch Finley

Southwest Microwave, Inc.
2922 South Roosevelt Street
Tempe, AZ 85282
800-587-5995
602-968-5995
Key Personnel: Tom Wallace,
National Sales Manager, Gus Fitch,
Product Manager, Mike Kanche,
Director of Sales & Marketing
Product Categories: E

Specialty Products Mfg. Co.
291 Clark St., Ext. P.O. Box 158
Plantsville, CT 06479
203-621-6969
Fax: 203-621-6969
Key Personnel: David T. Randall, Pres.
Product Categories: G
See ad on page 16

Speedypik® Corp.
378 Washington St.
Woburn, MA 01801
617-567-1111
Fax: 617-277-7777
Key Personnel: William J. Cimino,
Inventor Locksmith
Product Categories: D

Spirit II Inc.
20430 County Rd. #8
Bristol, IN 46507
219-848-7278
Key Personnel: Randy Bryant

Stanley Hardware Division
480 Myrtle St.
New Britain, CT 06053
203-225-5111
Fax: 203-827-5729
Key Personnel: Steve N. Curran, VP

Sales, John W. Cooper, VP Arch.
Oper.
Product Categories: B E

Star Key Industries, Inc.
29 Scott Ave.
Brooklyn, NY 11237
718-821-8300
Fax: 718-821-8305
Key Personnel: Richard S. Cohen,
Pres., Angel Rodriguez, Cust. Svc.
Product Categories: F

STAT Lock
#2 Ellis Rd.
Havertown, PA 19083
800-286-7412
610-872-7446
Fax: 610-872-6378
Key Personnel: Jacqueline J. Schrader,
Pres., Kenneth Schrader, VP, Anthony
Schrader, VP
Product Categories: F

Steadfast Corporation
229 Marginal St.
Chelsea, MA 02150
800-342-5911
617-889-3400
Fax: 617-889-2424
E Mail: steadfas@tiac.net
Key Personnel: Mitko Zagoroff, Pres.,
Jim Easterwood, Sales, Sandy Moy,
Mktg.
Product Categories: F

Steck Mfg. Co., Inc.
1115 South Broadway
Dayton, OH 45408
800-227-8325
513-222-0062
Fax: 513-222-6666
Key Personnel: Ray Steck, Laurence
Steck, VP, William Sharp, Nat'l. Sales
Mgr.
Product Categories: G

Steelman/JS Products, Inc.
4083 S. Industrial Rd.
Las Vegas, NV 89103
702-362-7011
Fax: 702-362-5084
Key Personnel: Allen Sharpless, VP
Sales & Mktg.

STRATTEC Security Corp.
3333 W. Good Hope Rd.
Milwaukee, WI 53209
414-247-3333
Fax: 414-247-3329
Key Personnel: Mike Elliot, VP Sales &
Mktg., Scot Hooper, Mgr. Aftermarket
Sales & Svc.
Product Categories: C E F G
See ad on page 135

Streamlight, Inc.
1030 W. Germantown Pike
Norristown, PA 19403
215-631-0600
Fax: 215-631-0600
Key Personnel: Mary Ellen Giangiulio

Strong Arm Security, Inc.
2228 Kenry Way
S. San Francisco, CA 94080
415-952-7710
Fax: 415-952-7710
Key Personnel: R. Volosing, Pres.,
Zona Volosing, Sec., Jeffrey Volosing,
Financial Officer
Product Categories: G

Sully Tools, Inc.
3515 Nodding Pine Ct.
Fairfax, VA 22033
703-689-3416
Fax: 703-787-0869
Key Personnel: Patrick H. Sullivan,
Pres., Nancy M. Sullivan, VP
Product Categories: C G

Suncoast Security Inc.
507 W. Bay Dr.
Largo, FL 34640
800-441-2218
813-585-2859
Fax: 813-585-2859
Key Personnel: Bill McConn, Owner,
Gail Cline, Office Mgr.
Product Categories: F

Supra Products, Inc.
P.O. Box 3167, 2611 Pringle Rd. SE
Salem, OR 97302
800-547-0252
503-581-9101
Fax: 503-364-1285
Key Personnel: Larry Springgate, Con.
Accts. Mgr., Terry Vulcani, Dir. Sales
& Mktg., Barbara Camper, Cust.
Supp. Spec.
Product Categories: E F

Synergistics
9 Tech Circle
Natick, MA 01760
508-655-1340
Fax: 508-651-2902
Key Personnel: David Longworth, Pres.,
Robert Pogorelc, VP, Mike Kasuha,
Treas.
Product Categories: E

Tag-It!
P.O. Box 4202
Kenmore, NY 14217
800-627-2444
716-871-7084
Fax: 716-447-9002
Key Personnel: Gary Gardinier,
Owner
Product Categories: GTalk-A-Phone
Company
5013 N. Kedzie Ave.
Chicago, IL 60625
312-539-1100
Fax: 312-539-1241
Key Personnel: Zvie Liberman, Pres.,
Bob Shanes, Mktg. Dir.
Product Categories: E
See ad on page 116

Tamperproof Screw Co., Inc.
30 Laurel St.
Hicksville, NY 11801
516-931-1616
Fax: 516-931-1654
Key Personnel: Lewis Friedman, Pres.,
Alaina Picitelli, VP, George Friedman,
Sales Mgr.
Product Categories: B

Tane Alarm Products
247-40 Jericho Tpke.
Floral Pk., NY 11001
800-852-5050
516-328-9292
Fax: 516-326-9125
Key Personnel: Tab M. Hauser, VP
Sales & Mktg.
Product Categories: A

Tanner Bolt & Nut Corp.
783 East 42nd St.
Brooklyn, NY 11236
800-456-2658
718-434-4500
Fax: 718-434-3215
Key Personnel: Jeff Tanner, Pres.,
David Kram, Sales, Gil Dagoberto,
Sales
Product Categories: F G

Taymor Industries Inc.
1586 Zephyr Ave.
Hayward, CA 94544
800-388-9887
510-481-1706
Fax: 510-429-0397
Key Personnel: Andy Zalkow, Pres.,
Ron Viesterz, Nat'l. Sales Mgr.
Product Categories: B

Tech-Train Productions
P.O. Box 15401
Pensacola, FL 32514
800-356-0136
904-476-7197
Fax: 904-476-7410
E Mail: AOL techtrain, Compuserve
70662,1312
Key Personnel: Steve Young, Owner,
Rubi Hale, Office Mgr.
Product Categories: C D G
See ad on page 163

Telecourier, Inc.
950 W. Valley Rd., Ste. 3102
Wayne, PA 19087
Key Personnel: Mike Phelan, Mktg. Mgr.

Telkee Incorporated
60 Starlifter Rd.
Dover, DE 19901
302-678-7800
Fax: 302-678-7809
Key Personnel: Penny Reuss, Nat'l
Sales Mgr., William Bradley, Dir.
Sales & Mktg., Anthony Salamone,
Pres.
Product Categories: H

Telular-Adcor Security Products
4130 Shirley Dr. SW
Atlanta, GA 30336
800-229-2326
404-691-8920
Fax: 404-691-5569
Key Personnel: Robert C. Montgomery,
Pres., June Ballew, Dir. Sales, Sylvia
Hallison, Sales & Mktg. Mgr.
Product Categories: A E

The Auth-Florence Mfg. Co.
2101 N. Elston Ave.
Chicago, IL 60614
800-275-1747
312-384-3310
Fax: 312-384-3460
Key Personnel: Frank Vecchione, Nat'l.
Sales Mgr., Susan Gilbert, Cust. Svc.
Mgr. Lori Ladoucer, Reg. Sales Mgr.
Product Categories: B E F

The Broadway Collection
1010 W. Santa Fe, P.O. Box 1210
Olathe, KS 66051-1210
800-766-1966
913-782-6244
Fax: 800-782-0647
Key Personnel: Craig Miller, VP Mktg.
& Prod. Mch., David Miller, C.O.O.
John Miller, Nat'l. Sales Mgr.
Product Categories: B

The Canadian Locksmith Magazine
137 Vaughan Rd.
Toronto, Ont., Canada M6C 2L9
905-294-0660
Fax: 905-294-0394
Key Personnel: Arnold Sitnicolaas,
Publisher
Product Categories: C

The Great Gate Lock Co.
P.O. Box 7811
Lancaster, PA 17604-7811
717-392-6284
Fax: 717-392-2919
Key Personnel: Stephan, Platt, Pres.
Product Categories: F

The L.S. Starrett Company
121 Crescent St.
Athol, MA 01331
508-249-3551
Fax: 508-249-8495
Key Personnel: Charles Morrow, VP
Sales
Product Categories: G

The M.K. Morse Company
P.O. Box 8677
Canton, OH 44711
800-733-3377
216-453-8187
Fax: 800-729-1112 or 216-453-
1111
Key Personnel: Jack Comune, Exec.
VP, Cliff Williams, VP Mktg., Adam
Behrend, Sales Mgr.
Product Categories: G

Product Category Key

- A — Alarms
- B — Architectural Hardware
- C — Training Manuals & Materials
- D — Locksmith Software
- E — Electronic Security Products
- F — Locking Products
- G — Locksmith Tools & Equipment
- H — Safes & Safe Products

Continued on page 92

Continued from page 90

The National Guardian Corp.
777 W. Putnam Ave.
Greenwich, CT 06830
203-531-3500
Key Personnel: Lisa Turner

The National Locksmith
1533 Burgundy Parkway
Streamwood, IL 60107
Key Personnel: Marc Goldberg,
Editor/Publisher
708-837-2044
Fax: 708-837-1210
E Mail: AOL Natl Lock, Internet
natllock@aol.com

The Penetrator
7370 Turkey Point Dr.
Titusville, FL 32780
407-267-0700
Key Personnel: Lew F. Noyes, Jr. CML
Owner, Eleanor M. Noyes, Owner
Product Categories: G

The Safer Image
P.O. Box 14444
Columbus, OH 43214
604-447-0000
Fax: 614-421-0008
Key Personnel: Tim Finley

Thorvie International Saw
1516 Buffalo St.
Green Bay, WI 54313
414-497-0572
Fax: 414-497-2016
Key Personnel: Al Viegut

Titan Tool Co.
P.O. Box 569
Buffalo, NY 14207
716-873-9907
Key Personnel: Ted Tahn

Top Lock
4301 Glenwood Rd.
Brooklyn, NY 11210
800-972-0947
718-434-6977
Fax: 718-434-4463
Key Personnel: Paul Reiss, Robert
Miller, Sec., Robert Reiss, Pres.
Product Categories: F

Trans Atlantic Co.
440 Fairmount Ave.
Philadelphia, PA 19123
800-523-9956
215-629-0400
Fax: 800-531-0844
Key Personnel: Norman Millman,
President, Berne Davis, Vice President
Sales
Product Categories: B F

Treskat USA
725 Adriane Park Circle
Kissimmee, FL 34744
800-645-5657
407-870-9696
Fax: 407-870-9696
E Mail: treskat
Key Personnel: Ray Nazarro, Pres.
Product Categories: D
See ads on pages 28 & 29

Trine Products Company
1430 Ferris Pl.
Bronx, NY 10461-3699
718-829-4796
Fax: 718-518-7022
Key Personnel: William J.
Schildnachter, Dir., Sales/Mktg., Tim
Harding, Nat'l. Sales Mgr.
Product Categories: E F

Tripp Lite
500 N. Orleans St.
Chicago, IL 60610
312-755-5400
Fax: 312-644-6505
E Mail: info@triplite@mcimail.com
Key Personnel: Ray Foster, Nat'l. Sales
Mgr., Rich Garling, Acct. Exec.
Product Categories: G

Tru Hone Corporation
1721 NE 19th Ave.
Ocala, FL 34470

904-622-1213
Fax: 904-622-9180
Key Personnel: James Ganglehoff, VP

Tufloc
P.O. Box 9238
Canton, OH 44711
800-321-0870
216-452-9132
Fax: 216-452-2557
Key Personnel: Bill Frye, Service, Dot
Pulfin, Svc.
Product Categories: F G

U-Change Lock Industries, Inc.
1640 West Highway 152
Mustang, OK 73064
800-253-5625
405-376-1600
Fax: 405-376-6870
Key Personnel: Russell Myers, VP Sales
& Mktg., Bill Dillard, Pres., Jean
Shuford, Cust. Svc. Dir.
Product Categories: B F H

U.S. Security Safe Corp.
3015 Dolores St.
Los Angeles, CA 90065
818-242-3156
Fax: 818-242-7638
Key Personnel: Phillip Alfeld, Pres.,
Larry McCall, VP Mktg. Sales, Jean
Sawyer, VP Adm.
Product Categories: H

Ultra Hardware Products
1777 Hylton Rd.
Pennsauken, NJ 08110
800-426-6379
609-663-5050
Fax: 800-858-7210
Key Personnel: Dan Carpey, VP, Todd
Kendall, Sales Mgr., Herb Breggar,
Mdse. Mgr.
Product Categories: B F G

Universal Industrial Products Co.
One Coreway Drive
Pioneer, OH 43554
800-922-6957
419-737-2324
Fax: 419-737-2130
Key Personnel: Neil L. Marko,
President, Richard Frankel, Vice
President, Sales & Mktg., Amy Mock,
Customer Service, Hinges
Product Categories: B

Uilmaster Corp.
P. O. Box 585
Wakarusa, IN 46573-0585
219-862-3233
Fax: 219-862-4517
Key Personnel: Gregg KinKade, Dir.
Mktg.

Valley Forge Security Products
90-1 Plant Ave.
Hauppauge, NY 11788
800-645-5604
516-435-1400
Fax: 516-435-1475
Key Personnel: Mel Minoff, Pres., Sal
J. Saccullo, VP
Product Categories: F

Valli & Valli (USA) Inc.
1540 Highland Ave., P.O. Box 245
Duarte, CA 91009
800-423-7161
818-359-2569
Fax: 818-358-0743
Key Personnel: Dennis D'Amore,
General Manager, Marinella Formenti,
Director
Product Categories: B F

Vern Rose Tool
8605 Commerce
San Diego, CA 92111
619-695-3384
Fax: 619-695-3387
Key Personnel: Dennis Pinn, Owner

**Very Easy MK Software
(Key Code Generator)**
703 Pier Ave., Suite B
Hermosa Beach, CA 90254
800-789-3089

310-798-5397
Fax: 310-798-4604
Key Personnel: Robin Varian
Product Categories: D
See ad on page 125

Videolarm
2525 Park Central Blvd.
Decatur, GA 30035
800-554-1124
404-987-7550
Fax: 404-987-9839
Key Personnel: Tommy Downs, Art
Dir., Graphics Des.
Product Categories: A

Vigilante Burglar Bars, Inc.
P. O. Box 523
Bronx, NY 10460
718-328-3700
Fax: 718-893-7168
Key Personnel: Larry Kaufman, Sales
Mgr.
Product Categories: F

Vindicator
3001 Bee Caves Rd.
Austin, TX 78746-5561
512-314-1200
Fax: 512-314-1270
E Mail: vind.lock@vind.com
Key Personnel: Howard Dame, VP &
GM, Jim Wilks, Nat'l. Sales Dir., Polly
Dame, Mktg. Mgr.
Product Categories: E F

Vingcard
9333 Forest Lane
Dallas, TX 75243-4205
214-907-2273
Key Personnel: Steve Hovanetz

Viscount Communication & Control
Syst.
105 East 69th Ave.
Vancouver, B.C., Canada V5X 2W9
604-327-9446
Fax: 604-327-3859
E Mail: khansen@viscount.com
Key Personnel: K.E. Hansen, Inter.
Sales Mgr.
Product Categories: E

Voice Strategies
4555 Corporate Dr., Ste. 306
Troy, MI 48098
810-641-8600
Fax: 810-641-8590
Key Personnel: George Lang, Pres.
Product Categories: E

Von Duprin, Inc.
2720 Tobey Dr.
Indianapolis, IN 46219
317-897-9944
Fax: 317-899-9302
Key Personnel: Don McAtee, Nat'l.
Sales Mgr.
Product Categories: B E

WD-40 Co.
P.O. Box 80607
San Diego, CA 92138-0607
619-275-1400
Fax: 619-275-5823
Key Personnel: Gerlad Schlieff, Pres.,
Paul Thompsen, VP North America,
Steve Schwab, Sales Mgr. Nat'l.
Product Categories: G

Weiser Lock
6660 S. Broadmoor Rd.
Tucson, AZ 85746
602-741-6242
Fax: 602-741-6241
Key Personnel: Vern Schroeder, Pres.

Weslock National, Inc.
13344 S. Main St.
Los Angeles, CA 90061
800-575-BOLT (2658)
310-327-2770
Fax: 310-324-4624
Key Personnel: Robert Pacelli, VP Sales
& Mktg., Joseph Bockrath, Pres.,
Patricia Avery, C.F.O.
Product Categories: F

Wilson Bohannon Co.
P. O. Drawer 504

Marion, OH 43301
614-382-3639
Fax: 614-383-1653
Key Personnel: William Houck, Pres.

Wilson Safe Co.
3031 Island Ave.
Philadelphia, PA 19153
800-345-8053
215-492-7100
Fax: 215-492-7104
Key Personnel: Ray Wilson, VP,
Margie Larkin
Product Categories: H
See ad on page 61

Winfield Architectural Lock
2875 NE 191st St.
Aventura, FL 33180
800-938-7330
305-937-7330
Fax: 305-937-7329
Key Personnel: David Klein, Pres.,
Steve Williamson, VP, Phil Wilder,
Mktg. Mgr.
Product Categories: B C D E H

Winner International
32 West State St.
Sharon, PA 16146
412-981-1566
Fax: 412-981-5844
Key Personnel: John Van Fassan

XL Lock Inc.
2328 N. Batavia #112
Orange, CA 92665-2026
714-282-2927
Fax: 714-282-8239
Key Personnel: Lou Bone, Pres., Carol
Bone, VP
Product Categories: F

Yale®, Div. of Yale Security Inc.
P.O. Box 25288
Charlotte, NC 28229-80101
800-438-1951
704-283-2101
Fax: 704-289-2875
Key Personnel: Patrick J. McCord,
Pres., Jack Hutson, VP Sales & Mktg.
Thomas P. Kaika, Nat'l. Sales Mgr.
Product Categories: B

Young Bros. Stamp Works
P.O. Box 75
Muscatine, IA 52761
800-553-8248
319-263-3575
Fax: 319-263-8003
Key Personnel: Jim Young, Pres., JoAnn
Frost, Randy Johnson
Product Categories: G
See ad on page 67

Z-Lock Mfg. Co.
P.O. Box 949
Redondo Beach, CA 90277
310-316-7709
Key Personnel: Jay S. Derman, Owner
Product Categories: F

Zero International Inc.
415 Concord Ave.
Bronx, NY 10455
800-635-5335
718-585-3230
Fax: 718-292-2243 or 800-851-
0000
Key Personnel: Elias Wexler, Pres.,
Stephen F. Petko, Sales Mgr., Michael
Gardner, Plant Mgr.
Product Categories: B

Product Category Key

- A — Alarms
- B — Architectural Hardware
- C — Training Manuals & Materials
- D — Locksmith Software
- E — Electronic Security Products
- F — Locking Products
- G — Locksmith Tools & Equipment
- H — Safes & Safe Products



MANUFACTURERS by PRODUCT

Alarms

A.D.D.M. International Inc.
Oceanside, NY
516-766-5997
Fax: 516-678-0259

American Auto Accessories, Inc.
Corona, NY
800-THE-1800
Fax: 718-458-9110

AMSECO
Carson, CA
800-421-1096
Fax: 310-538-9932

APEX, A Division of Pittway Corp.
Raleigh, NC
800-272-7937
Fax: 919-850-0977

APR Industries, Inc.
Boonton, NJ
800-729-2674
Fax: 201-335-3008

Arrow Lock Mfg. Co.
Brooklyn, NY
800-233-0478
Fax: 718-649-9097

Belwith International, Ltd.
Grandville, MI
800-235-9484
Fax: 616-531-6055

Burle Philips Comm. & Sec. Sys. Inc.
Lancaster, PA
800-326-3270
Fax: 717-295-6097

C&A Control Systems
Knoxville, TN
800-346-0999
Fax: 615-922-9999

Crimestopper Security Products, Inc.
Simi Valley, CA
805-526-9400
Fax: 805-581-9500

DADCO Mfg. Corp.
Deer Park, NY
800-DADCO NY
Fax: 516-242-0611

Delta Vehicle Security
Sun Valley, CA
800-356-9562
Fax: 818-771-0785

Detec Security Systems, Inc.
San Clemente, CA
800-967-2446
Fax: 714-366-9436

Detex Corp.
New Braunfels, TX
800-729-3839
Fax: 210-620-6711

Door Controls Int'l.
Dexter, MI
800-742-3634
Fax: 800-742-0410

Fort Lock Corp.
River Grove, IL
708-456-1100
Fax: 708-456-9476 or 456-1197

Harrison Electronic Systems
Wilkes-Barre, PA
800-422-5050
Fax: 717-823-6343

Hirsch Electronics Inc.
Irvine, CA
714-250-8888
Fax: 714-250-7372

Honeywell Home Control
Golden Valley, MN
800-328-5111
Fax: 612-954-6799

Ilco Unican
Rocky Mount, NC
800-334-1381
Fax: 919-446-4702

Ilco Unican/Marlok Division
Winston-Salem, NC
800-849-8324
Fax: 910-725-3269

KingAlarm
Hackensack, NJ
800-526-0162
Fax: 201-342-6194

KXL Corp.
River Grove, IL
708-453-1788
Fax: 708-456-9476

L&S Security Products
Gardena, CA
310-532-4988
Fax: 310-532-4988

Lion Security Products
Minneapolis, MN
800-477-7657
Fax: 612-789-2795

Lock-Tight
San Raphael, CA
415-492-0527
Fax: 415-472-6134

MACE Security International
Bennington, VT
800-255-2634
Fax: 800-545-6223

Macro Media Systems, Inc.
Marrimack, NH
603-424-2674
Fax: 603-429-0783

Mosler
Hamilton, OH
800-543-4584
Fax: 513-870-1071

O-Mega
Los Angeles, CA
800-553-0222
Fax: 310-837-0942

Phoenix Industries Inc.
Linwood, KS
800-238-3203
Fax: 913-723-3507

Positive Lock, Inc.
Russellville, AR
800-342-7670
Fax: 800-531-5293

Radionics
Salinas, CA
800-538-5807
Fax: 408-757-2438

RB Enterprises
Coarsegold, CA
800-452-5276
Fax: 209-642-2699

Rokonet Industries USA
Elmsford, NY
800-344-2025
Fax: 914-592-1271

Safety One Inc.
Beachwood, OH
800-567-9765

Safety Technology International, Inc.
Waterford, MI
800-888-4784
Fax: 810-673-1246

SecoLarm
Irvine, CA
800-662-0800
Fax: 714-261-7326

Securitech Group, Inc.
Maspeth, NY
800-625-LOCK
Fax: 718-392-8944

Sentrylok Corp.
Twinsburg, OH
216-425-1354
Fax: 216-425-1884

Solutions Worldwide
Surrey, BC, Canada
800-883-9388
Fax: 604-582-4386

Source of Safety, International
Columbus, OH
800-421-9496
Fax: 614-421-0008

Tane Alarm Products
Floral Pk., NY
800-852-5050
Fax: 516-326-9125

Telular-Adcor Security Products
Atlanta, GA
800-229-2326
Fax: 404-691-5569

Videolarm
Decatur, GA
800-554-1124
Fax: 404-987-9839

Architectural Hardware

Abloy Disklock Pro
Brooklyn, NY
718-927-2772
Fax: 718-257-2772

Access Protection Corp.
Plaistow, NH
603-382-0822
Fax: 603-382-0833

Access Specialties & Products
Bensenville, IL
800-853-8377
Fax: 708-766-2609

Access Technology, Inc.
Redmond, WA
206-556-0357
Fax: 206-558-1205

Accurate Lock & Hardware Co.
Stamford, CT
203-348-8865
Fax: 203-348-5234

Adams Rite Manufacturing Co.
City of Industry, CA
800-872-3267
Fax: 310-699-5094

Advanced Hardware Technologies
Charlotte, NC
800-277-9377
Fax: 704-525-7337

ALK Contractors Supply Corp.
Roselle, IL
708-894-0041
Fax: 708-894-8081

Almet Inc.
Montreal, Canada
514-364-4211
Fax: 514-364-4912

American Device Mfg. Co.
Steeleville, IL
800-637-3763
Fax: 800-553-2362

APR Industries, Inc.
Boonton, NJ
800-729-2674
Fax: 201-335-3008

Arrow Lock Mfg. Co.
Brooklyn, NY
800-233-0478
Fax: 718-649-9097

ASSA High Security Locks
Brooklyn, NY
718-927-2772
Fax: 718-257-2772

Auth Chimes/Authentic Parts
Deer Park, NY
800-229-AUTH
Fax: 516-242-7742

Baldwin Hardware Corp.
Reading, PA
610-777-7811
Fax: 610-775-5567

Barry Supply Co./Div. of Barry Ind.
New York, NY
212-242-5200
Fax: 212-675-7094

Baton Lock & Hardware Co.
Garden Grove, CA
800-395-8880
Fax: 714-265-3630

CCL Security Products
New Britain, CT
800-733-8588
Fax: 203-223-7601

Corbin Russwin Architectural
Hardware
Berlin, CT
203-225-7411
Fax: 203-828-7266

Courtaulds Performance Films
Martinsville, VA
800-255-8627
Fax: 540-627-3032

Deronde Products, Inc.
Buffalo, NY
800-346-8926
Fax: 716-895-9987

Dom Security Locks N.A.
Brockville, Ont., Canada
613-498-9415
Fax: 613-498-5820

Domus Industries, Inc.
Indianapolis, IN
317-898-8870
Fax: 317-898-1130

Don-Jo Manufacturing
Sterling, MA
800-628-8389
Fax: 508-422-3467

Door Aid® Div. of M.S.S.
Mattawan, MI
800-526-5672

Door Controls Int'l.
Dexter, MI
800-742-3634
Fax: 800-742-0410

Door Spy - Rudolph-Desco Co., Inc.
Englewood Cliffs, NJ
201-568-4920
Fax: 201-568-0971

Dor-O-Matic Inc.
Harwood Heights, IL
800-815-1517
Fax: 708-867-5227

DORMA Door Controls Inc./The
DORMA Group
Reamstown, PA
800-523-8483
Fax: 800-274-9724

Emtex Products, Inc.
City of Industry, CA
800-356-2741
Fax: 800-577-5771

Folger Adam Company
Lemont, IL
708-739-3900

Fort Lock Corp.
River Grove, IL
708-456-1100
Fax: 708-456-9476 or 456-1197

G-U Hardware Inc.
Newport News, VA
800-927-1097
Fax: 804-873-1298

Gainsborough Hardware Ind. Inc.
Norcross, GA
800-845-5662
Fax: 404-448-7070

Glynn Johnson
Indianapolis, IN
800-525-0336
Fax: 800-525-0337

H.B. Ives
Wallingford, CT
203-294-4837
Fax: 203-284-1460

Hager Hinge Co.
St. Louis, MO
800-325-9995
Fax: 800-782-0149

Hardware Technologies Ltd.
Ft. Atkinson, WI
414-563-2626
Fax: 414-563-4408

HEWI Inc.
Lancaster, PA
717-293-1313
Fax: 717-293-3270

Horton Automatics
Corpus Christi, TX
800-531-3111
Fax: 512-888-6510

Italbrass Corporation
Marblehead, MA
617-639-1992
Fax: 617-639-2458

Keedex Manufacturing
Garden Grove, CA
714-636-5657
Fax: 714-636-5680

Knox Company
Irvine, CA
800-552-5669
Fax: 714-252-0482

L&S Security Products
Gardena, CA
310-532-4988
Fax: 310-532-4988

Lanson Industries
Muskego, WI
414-679-0045
Fax: 414-679-2505

Latch-Gard Co., Inc.
Wakarusa, IN
219-862-2373
Fax: 219-862-2459

Liberty Hardware Mfg. Co.
High Point, NC
800-LIBERTY
Fax: 910-434-3364

M.A.G. Eng. & Mfg. Inc.
Huntington Beach, CA
800-624-9942
Fax: 714-892-6845

Magnokrom, Inc.
Scarborough, Ont., Canada
416-299-0000
Fax: 416-299-3728

Major Metalfab Inc. (MMF)
Wheeling, IL
800-445-8293
Fax: 708-537-1120

Markar Products, Inc.
Lancaster, NY
800-866-1688
Fax: 716-685-3919

MARKS U.S.A.
Amityville, NY
800-526-0233
Fax: 516-225-6136

Master Lock Company
Milwaukee, WI
414-444-2800
Fax: 414-449-3162

Maxim Technologies Inc.
Bronx, NY
718-548-9219
Fax: 718-548-9219

Merit Metal Products Corp.
Warrington, PA
215-343-2500
Fax: 215-343-4839

Miwa Lock, Canada
Edmonton, AB, Canada
403-453-5226
Fax: 403-452-7551

National Guard Products, Inc.
Memphis, TN
800-647-7874
Fax: 800-255-7874

Norden Lock Co., Inc.
Bohemia, NY
800-233-5625
Fax: 516-563-1742

NT Monarch Hardware & Mfg. Co.
Shepherdsville, KY
800-826-5792
Fax: 502-543-3089

NT Quality Hardware Mfg.
Brea, CA
800-345-8819
Fax: 800-345-8820

Omnia Industries, Inc.
Cedar Grove, NJ
201-239-7272
Fax: 201-239-5960

PDQ Industries
Leola, PA
800-441-9692
Fax: 717-656-6892

PEMCO Inc.
Ventura, CA
800-283-9988
Fax: 805-642-4109



***To be a World Leader You Need Quality Products,
Innovative Technology and Strong Partners.***

[Click here for more information](#)

Architectural Hardware continued

Period Brass
Jamestown, NY
800-332-6677
Fax: 800-215-8837

Phoenix Industries Inc.
Linwood, KS
800-238-3203
Fax: 913-723-3507

Positive Lock, Inc.
Russellville, AR
800-342-7670
Fax: 800-531-5293

Precision Hardware
Romulus, MI
313-326-7500
Fax: 313-326-7540

Pride Barco Lock Company
Santa Barbara, CA
800-578-1816
Fax: 805-965-2535

R.R. Brink Locking Systems Inc.
Shorewood, IL
815-744-7000
Fax: 815-744-7020

Reilor Inc.
Horsham, PA
800-521-5294
Fax: 215-956-0553

Rofu International Corp.
Tacoma, WA
800-255-ROFU
Fax: 206-922-1728

Rudolph-Desco Company, Inc.
Englewood Cliffs, NJ
201-568-4920
Fax: 201-568-0771

S. Parker Hardware Mfg. Corp.
Englewood, NJ
800-S-PARKER
Fax: 201-569-1082

Sealeze Corp.
Richmond, VA
800-446-7325
Fax: 800-448-2908

Securitech Group, Inc.
Maspeth, NY
800-625-LOCK
Fax: 718-392-8944

Select Products Limited
Kalamazoo, MI
800-423-1174
Fax: 800-423-7107

Sentrylok Corp.
Twinsburg, OH
216-425-1354
Fax: 216-425-1884

Stanley Hardware Division
New Britain, CT
203-225-5111
Fax: 203-827-5729

Tamperproof Screw Co., Inc.
Hicksville, NY
516-931-1616
Fax: 516-931-1654

Taymor Industries Inc.
Hayward, CA
800-388-9887
Fax: 510-429-0397

The Auth-Florence Mfg. Co.
Chicago, IL
800-275-1747
Fax: 312-384-3460

The Broadway Collection
Olathe, KS
800-766-1966
Fax: 800-782-0647

Trans Atlantic Co.
Philadelphia, PA
800-523-9956
Fax: 800-531-0844

U-Change Lock Industries, Inc.
Mustang, OK
800-253-5625
Fax: 405-376-6870

Ultra Hardware Products
Pennsauken, NJ
800-426-6379
Fax: 800-858-7210

Universal Industrial Products Co.
Pioneer, OH
800-922-6957
Fax: 419-737-2130

Valli & Valli (USA) Inc.
Duarte, CA
800-423-7161
Fax: 818-358-0743

Von Duprin, Inc.
Indianapolis, IN
317-897-9944
Fax: 317-899-9302

Winfield Architectural Lock
Aventura, FL
800-938-7330
Fax: 305-937-7329

Yale®, Div. of Yale Security Inc.
Charlotte, NC
800-438-1951
Fax: 704-289-2875

Zero International Inc.
Bronx, NY
800-635-5335
Fax: 718-292-2243 or 800-851-0000

Training Manuals & Materials

Aanon/Safetron
Englewood, CO
303-781-1413
Fax: 303-783-0087

Acclaim Images, LLC
Midlothian, TX
214-296-6785
Fax: 214-296-7110

All-Lock Co., Inc.
Selma, AL
334-874-9001
Fax: 334-874-6011

APR Industries, Inc.
Boonton, NJ
800-729-2674
Fax: 201-335-3008

Base Industries
Corona, CA
800-554-8088
Fax: 909-371-2828

Corbin Russwin Architectural
Hardware
Berlin, CT
203-225-7411
Fax: 203-828-7266

Custom Security Products
Simi Valley, CA
805-522-5580
Fax: 805-522-9959

David Levy Company, Inc.
Cerritos, CA
800-421-3536
Fax: 310-404-9698

Folger Adam Company
Lemont, IL
708-739-3900

Fort Lock Corp.
River Grove, IL
708-456-1100
Fax: 708-456-9476 or 456-1197

HPC, Inc.
Schiller Park, IL
800-323-3295
Fax: 708-671-6343

Intelligent Controls Inc.
Lynnwood, WA
800-842-0221
Fax: 206-775-1641

Intersek
Englewood, CO
303-871-1413
Fax: 303-788-1899

KingAlarm
Hackensack, NJ
800-526-0162
Fax: 201-342-6194

Lockmounts
Lancaster, KY
606-792-6526
Fax: 606-792-6526

MACE Security International
Bennington, VT
800-255-2634
Fax: 800-545-6223

Markar Products, Inc.
Lancaster, NY
800-866-1688
Fax: 716-685-3919

Medeco Security Locks, Inc.
Salem, VA
800-548-8472
Fax: 703-380-5010

MSD
Amissville, VA
703-349-1120
Fax: 703-349-1538

Mul-T-Lock USA Inc.
Lodi, NJ
800-562-3511
Fax: 201-778-4007

Pro-Lok
Orange, CA
714-633-0681
Fax: 714-633-0470

Safety One Inc.
Beachwood, OH
800-567-9765

Securitech Group, Inc.
Maspeth, NY
800-625-LOCK
Fax: 718-392-8944

Slide Lock Tool Co., Inc.
Louisville, TN
800-336-8812
Fax: 577-5936

STRATEC Security Corp.
Milwaukee, WI
414-247-3333
Fax: 414-247-3329

Sully Tools, Inc.
Fairfax, VA
703-689-3416
Fax: 703-787-0869

Tech-Train Productions
Pensacola, FL
800-356-0136
Fax: 904-476-7410

The Canadian Locksmith Magazine
Toronto, Ont., Canada
905-294-0660
Fax: 905-294-0394

The National Locksmith
1533 Burgundy Parkway
Streamwood, IL 60107
Key Personnel: Marc Goldberg,
Editor/Publisher
708-837-2044
Fax: 708-837-1210
E Mail: AOL Natl Lock, Internet
natlock@aol.com

Winfield Architectural Lock
Aventura, FL
800-938-7330
Fax: 305-937-7329

Locksmith Software

Acclaim Images, LLC
Midlothian, TX
214-296-6785
Fax: 214-296-7110

Blackhawk Products
Dolores, CO
970-882-7191
Fax: 970-882-7228

Corbin Russwin Architectural
Hardware
Berlin, CT
203-225-7411
Fax: 203-828-7266

DALAX, Inc. / Hal Simon Co.
Richardson, TX
214-234-8009
Fax: 214-234-0339

DLA Security Systems, Inc.
Westfield, NJ
908-233-7755

HPC, Inc.
Schiller Park, IL
800-323-3295
Fax: 708-671-6343

KeySoft Masterkey Software
Salt Lake City, UT
801-972-1369
Fax: 801-972-1369

Locksoft, Inc.
Hastings, NE
402-461-4149
Fax: 402-461-4359

MBI Business Software
Sacramento, CA
800-551-4624
Fax: 916-393-0930

Moore Software Development
Amissville, VA
800-270-0362
Fax: 540-349-1538

MSD
Amissville, VA
703-349-1120
Fax: 703-349-1538

Mul-T-Lock USA Inc.
Lodi, NJ
800-562-3511
Fax: 201-778-4007

Rudolph-Desco Company, Inc.
Englewood Cliffs, NJ
201-568-4920
Fax: 201-568-0971

Silca Keys U.S.A., Inc.
Twinsburg, OH
800-648-9239
Fax: 216-487-5459

Speedypik® Corp.
Woburn, MA
617-567-1111
Fax: 617-277-7777

Tech-Train Productions
Pensacola, FL
800-356-0136
Fax: 904-476-7410

Treskat USA
Kissimmee, FL
800-645-5657
Fax: 407-870-9696

Very Easy MK Software (Key Code Generator)
Hermosa Beach, CA
800-789-3089
Fax: 310-798-4604

Winfield Architectural Lock
Aventura, FL
800-938-7330
Fax: 305-937-7329

Electronic Security Products

Aanon/Safelron
Englewood, CO
303-781-1413
Fax: 303-783-0087

Access Technology, Inc.
Redmond, WA
206-556-0357
Fax: 206-558-1205

Aiphone Communications Systems
Bellevue, WA
800-692-0200 (orders only)
Fax: 206-455-0071

Alarm Lock Systems, Inc.
Amityville, NY
800-ALA-LOCK
Fax: 516-789-3383

Alarm-Saf
Wilmington, MA
508-658-6717
Fax: 508-658-8638

Allied * Gary International
Waynesboro, GA
800-456-4279
Fax: 706-554-3319

Allsafe Company, Inc.
Buffalo, NY
800-828-7162
Fax: 716-896-4241

Alltronix Corporation
Brooklyn, NY
718-567-8181
Fax: 718-567-9056

American Device Mfg. Co.
Steeleville, IL
800-637-3763
Fax: 800-553-2362

American Magnetics Corporation
Callsbao, CA
213-775-8651
Fax: 310-834-0685

American Metal
San Marino, CA
818-292-1300
Fax: 818-292-FAX+

American Security Prod. Co.
Fontana, CA
800-421-6142
Fax: 909-685-9685

AMSECO
Carson, CA
800-421-1096
Fax: 310-538-9932

APEX, A Division of Pittway Corp.
Raleigh, NC
800-272-7937
Fax: 919-850-0977

Architectural Control Systems, Inc.
St. Louis, MO
800-753-5558
Fax: 314-432-2090

Auth Chimes/Authentic Parts
Deer Park, NY
800-229-AUTH
Fax: 516-242-7742

Base Industries
Corona, CA
800-554-8088
Fax: 909-371-2828

Besam Automatic Door Systems
Hightstown, NJ
800-752-9290
Fax: 609-443-3440

Brown Safe Mfg.
San Marcos, CA
800-698-2358
Fax: 619-744-4055

Burle Phillips Comm. & Sec. Sys. Inc.
Lancaster, PA
800-326-3270
Fax: 717-295-6097

C&A Control Systems
Knoxville, TN
800-346-0999
Fax: 615-922-9999

Cardkey Systems, Inc.
Simi Valley, CA
805-522-5555
Fax: 805-522-9215

CCTV Corp.
S. Hackensack, NJ
800-221-2240
Fax: 201-489-0111

Cellular Alarm Prod., Ltd.
Dallas, TX
800-752-9719
Fax: 214-620-7205

Chinon America, Inc.
Mountainside, NJ
800-932-0374
Fax: 908-654-6656

Chugai Boyeki (America) Co.
Torrance, CA
310-618-8615
Fax: 310-618-9963

Continental Prod. - Software House
Westbury, NY
800-242-1961
Fax: 516-334-0235

Corbin Russwin Architectural
Hardware
Berlin, CT
203-225-7411
Fax: 203-828-7266
Corby Industries, Inc.
Allentown, PA
800-652-6729
Fax: 610-435-1963

Crimestopper Security Products, Inc.
Simi Valley, CA
805-526-9400
Fax: 805-581-9500

DADCO Mfg. Corp.
Deer Park, NY
800-DADCO NY
Fax: 516-242-0611

David Levy Company, Inc.
Cerritos, CA
800-421-3536
Fax: 310-404-9698

Defenders Network Inc.
Mobile, AL
800-513-1984
Fax: 334-661-3143

Delta Vehicle Security
Sun Valley, CA
800-356-9562
Fax: 818-771-0785

Detec Security Systems, Inc.
San Clemente, CA
800-967-2446
Fax: 714-366-9436

Detex Corp.
New Braunfels, TX
800-729-3839
Fax: 210-620-6711

Dom Security Locks N.A.
Brockville, Ont., Canada
613-498-9415
Fax: 613-498-5820

Door Controls Int'l.
Dexter, MI
800-742-3634
Fax: 800-742-0410

Doorguard Systems, Inc.
Columbia, MD
800-442-6247
Fax: 410-992-5694

Dor-O-Matic Inc.
Harwood Heights, IL
800-815-1517
Fax: 708-867-5227

Dynalock Corporation
Forestville, CT
203-582-4761
Fax: 203-585-0338

Electronic Locking Specialties Inc.
E. Farmingdale, NY
800-526-9000
Fax: 516-753-6104

Essex Electronics Inc.
Carpinteria, CA
800-539-5377
Fax: 805-684-0232

Farfisa Intercoms
Miami, FL
800-806-0227
Fax: 305-593-9823

Folger Adam Company
Lemont, IL
708-739-3900



**Choose S&G Comptronic
electronic safe locks for...security...
technology...tradition.**

[Click here for more information](#)

MANUFACTURERS by PRODUCT

Electronic Security Products continued

Fort Lock Corp.
River Grove, IL
708-456-1100
Fax: 708-456-9476 or 456-1197

Frame, Inc.
Fullerton, CA
800-372-6346
Fax: 714-441-0543

GTO, Inc.
Tallahassee, FL
800-543-GATE
Fax: 904-575-8912

GYR, An Odetics Division
Anaheim, CA
800-854-6853
Fax: 800-388-6363

H-T Typo Inc.
Middle Village, NY
718-894-3321
Fax: 718-894-2674

Hanchett Entry Systems, Inc./H.E.S.
Inc.
Phoenix, AZ
800-626-7590
Fax: 602-582-4641

Harrison Electronic Systems
Wilkes-Barre, PA
800-422-5050
Fax: 717-823-6343

Hirsch Electronics Inc.
Irvine, CA
714-250-8888
Fax: 714-250-7372

Honeywell Home Control
Golden Valley, MN
800-328-5111
Fax: 612-954-6799

Horton Automatics
Corpus Christi, TX
800-531-3111
Fax: 512-888-6510

Identocard Technologies Corp.
Lancaster, PA
717-299-3610
Fax: 717-299-4122

Ilco Unican
Rocky Mount, NC
800-334-1381
Fax: 919-446-4702

Ilco Unican/Marlok Division
Winston-Salem, NC
800-849-8324
Fax: 910-725-3269

Indiana Cash Drawer Co.
Shelbyville, IN
800-227-4379
Fax: 317-392-0958

Infographic Systems Corp.
Los Alamitos, CA
714-220-4980
Fax: 714-828-5763

Intelligent Controls Inc.
Lynnwood, WA
800-842-0221
Fax: 206-775-1641

Intellock Technologies
Pleasanton, CA
800-562-5875
Fax: 510-225-0600

International Electronics Inc.
Canton, MA
800-343-9502
Fax: 617-821-4443

Intersek
Englewood, CO
303-871-1413
Fax: 303-788-1899

Kaba High Security Locks
Southington, CT
203-621-3601
Fax: 203-621-9727

Keedex Manufacturing
Garden Grove, CA
714-636-5657
Fax: 714-636-5680

Keri Systems, Inc.
San Jose, CA
800-260-5265
Fax: 408-441-0309

Key Systems, Inc.
Rochester, NY
800-888-3553
Fax: 716-654-7916

KEYBAK; A Div. of West Coast Chain
Mfg. Co.
Ontario, CA
909-923-7800
Fax: 909-923-0024

KXL Corp.
River Grove, IL
708-453-1788
Fax: 708-456-9476

L&S Security Products
Gardena, CA
310-532-4988
Fax: 310-532-4988

La Gard Inc.
Torrance, CA
310-325-5670
Fax: 310-325-5615

Lanson Industries
Muskego, WI
414-679-0045
Fax: 414-679-2505

Lee Electric, Inc.
West New York, NJ
800-433-3417
Fax: 201-866-0735

Lion Security Products
Minneapolis, MN
800-477-7657
Fax: 612-789-2795

Lock-Tight
San Raphael, CA
415-492-0527
Fax: 415-472-6134

Locknetics Security Engineering
Forestville, CT
203-584-9158
Fax: 203-584-2136

MACE Security International
Bennington, VT
800-255-2634
Fax: 800-545-6223

Macro Media Systems, Inc.
Marrimack, NH
603-424-2674
Fax: 603-429-0783

Marlee Electronics, Corp.
Philadelphia, PA
800-874-8036
Fax: 215-755-7877

Marshall Electronics
Culver City, CA
310-390-8608
Fax: 310-391-8926

Mas Hamilton Group, Inc.
Lexington, KY
800-950-4744
Fax: 606-253-4748

McGunn Safe Co.
Chicago, IL
800-621-2816
Fax: 708-458-3323

Medeco Security Locks, Inc.
Salem, VA
800-548-8472
Fax: 703-380-5010

Mnemonics, Inc.
Mt. Laurel, NJ
609-234-0970
Fax: 609-234-6793

Morse Watchmans Inc.
Oxford, CT
800-423-8256
Fax: 203-264-8367

Mosler
Hamilton, OH
800-543-4584
Fax: 513-870-1071

MRL, Inc.
Springfield, VA
800-989-9891
Fax: 703-569-0196

Nanotechnology, Inc.
Cupertino, CA
408-973-8280
Fax: 408-973-8280

National Electronics
River Grove, IL
800-722-2288
Fax: 708-452-3450

Nel-Tech
Michigan City, IN
800-874-2050
Fax: 219-874-9990

NKL Industries, Ltd., NKL Safe Co.
Chesapeake, VA
800-528-9900
Fax: 804-485-0271

Northern Computers, Inc.
Milwaukee, WI
800-323-4576
Fax: 414-769-5989

NT Monarch Hardware & Mfg. Co.
Shepherdsville, KY
800-826-5792
Fax: 502-543-3089

O-Mega
Los Angeles, CA
800-553-0222
Fax: 310-837-0942

Optex Inc. (HBA Division)
Torrance, CA
800-966-7839
Fax: 310-214-0131

OSI Security Devices
Sunnyvale, CA
408-720-0909
Fax: 408-720-9034

Pach & Company
San Clemente, CA
714-498-2951
Fax: 714-498-6879

Panasonic Broadcast & Television Sys.
Co.
Secaucus, NJ
201-392-4429
Fax: 201-348-7372

Pelco
Clovis, CA
800-289-9100
Fax: 209-292-3827 or 800-289-9150

Pentax Corporation/Cosmicar Lens
Division
Englewood, CO
303-799-8000
Fax: 303-643-0226

Pentax Corporation/Cosmicar Lens
Division
Englewood, CO
303-799-8000
Fax: 303-643-0226

Phoenix Industries Inc.
Linwood, KS
800-238-3203
Fax: 913-723-3507

Power Access Corporation
Collinsville, CT
800-344-0088
Fax: 203-693-0641

Precision Hardware
Romulus, MI
313-326-7500
Fax: 313-326-7540

Proprietary Control Systems
Corp.(PCSC)
Rancho Dominguez, CA
310-638-0400
Fax: 310-638-6204

R.R. Brink Locking Systems Inc.
Shorewood, IL
815-744-7000
Fax: 815-744-7020

Radionics
Salinas, CA
800-538-5807
Fax: 408-757-2438

Ridgewood House
Middle Village, NY
718-894-3321
Fax: 718-894-2674

Rofu International Corp.
Tacoma, WA
800-255-ROFU
Fax: 206-922-1728

Rutherford Controls, Inc.
Virginia Beach, VA
800-899-5625
Fax: 804-427-9549

Safety One Inc.
Beachwood, OH
800-567-9765

Safety Technology International, Inc.
Waterford, MI
800-888-4784
Fax: 810-673-1246

Samsung OPTO - Electronics America
Inc.
Secaucus, NJ
800-762-7746
Fax: 201-902-9342

Sargent & Greenleaf, Inc.
Nicholasville, KY
606-885-9411
Fax: 606-885-3063

Se-Kure Controls, Inc.
Franklin Park, IL
800-322-2435
Fax: 708-288-9999

Seco-Larm
Irvine, CA
800-662-0800
Fax: 714-261-7326

Secura Key
Chatsworth, CA
818-882-0020
Fax: 818-882-7052

Securitech Group, Inc.
Maspeth, NY
800-625-LOCK
Fax: 718-392-8944

Securtron Magnalock Corp.
Sparks, NV
800-MAG-LOCK
Fax: 702-355-5636

Securtron Magnalock Corp.
Sparks, NV
800-MAG-LOCK
Fax: 702-355-5636

Continued on page 100

**Electronic Security Products
Continued from page 98**

Security Door Controls
Westlake Village, CA
818-889-1622
Fax: 800-959-4732

Sentex Systems, Inc.
Chatsworth, CA
818-700-9800
Fax: 818-700-5000

Sentrylok Corp.
Twinsburg, OH
216-425-1354
Fax: 216-425-1884

SeQwill Corp.
Barrington, IL
708-381-0730
Fax: 708-381-1676

Solutions Worldwide
Surrey, BC, Canada
800-883-9388
Fax: 604-582-4386

Source of Safety, International
Columbus, OH
800-421-9496
Fax: 614-421-0008

Southwest Microwave, Inc.
Tempe, AZ
800-587-5995

Stanley Hardware Division
New Britain, CT
203-225-5111
Fax: 203-827-5729

STRATTEC Security Corp.
Milwaukee, WI
414-247-3333
Fax: 414-247-3329

Supra Products, Inc.
Salem, OR
800-547-0252
Fax: 503-364-1285

Synergistics
Natick, MA
508-655-1340
Fax: 508-651-2902

Talk-A-Phone Company
Chicago, IL
312-539-1100
Fax: 312-539-1241

Telular-Adcor Security Products
Atlanta, GA
800-229-2326
Fax: 404-691-5569

The Auth-Florence Mfg. Co.
Chicago, IL
800-275-1747
Fax: 312-384-3460

Trine Products Company
Bronx, NY
718-829-4796
Fax: 718-518-7022

Vindicator
Austin, TX
512-314-1200
Fax: 512-314-1270

Viscount Communication & Control
Syst.
Vancouver, B.C., Canada
604-327-9446
Fax: 604-327-3859

Voice Strategies
Troy, MI
810-641-8600
Fax: 810-641-8590

Von Duprin, Inc.
Indianapolis, IN
317-897-9944
Fax: 317-899-9302

Winfield Architectural Lock
Aventura, FL
800-938-7330
Fax: 305-937-7329

Locking Products

Aanon/Safeltron
Englewood, CO
303-781-1413
Fax: 303-783-0087

Abloys Disklock Pro
Brooklyn, NY
718-927-2772
Fax: 718-257-2772

Abloys Security, Inc.
Irving, TX
800-367-4598
Fax: 214-753-0792

Abus Lock Co.
Woburn, MA
800-225-5348
Fax: 617-938-7009

Access Protection Corp.
Plaistow, NH
603-382-0822
Fax: 603-382-0833

Access Technology, Inc.
Redmond, WA
206-556-0357
Fax: 206-558-1205

Accurate Lock & Hardware Co.
Stamford, CT
203-348-8865
Fax: 203-348-5234

Advanced Hardware Technologies
Charlotte, NC
800-277-9377
Fax: 704-525-7337

Aiphone Communications Systems
Bellevue, WA
800-692-0200 (orders only)
Fax: 206-455-0071

Alarm Lock Systems, Inc.
Amityville, NY
800-ALA-LOCK
Fax: 516-789-3383

All Safe & Security
West Allis, WI
800-310-3535
Fax: 414-546-6300

All-Lock Co., Inc.
Selma, AL
334-874-9001
Fax: 334-874-6011

Almont Lock Co., Inc.
Almont, MI
810-798-8950

Alpina/Calibro Corporation
Lemont, IL
708-257-8008

American Auto Accessories, Inc.
Corona, NY
800-THE-1800
Fax: 718-458-9110

American Lock Co.
Crete, IL
800-323-4568
Fax: 708-534-0531

American Metal
San Marino, CA
818-292-1300
Fax: 818-292-FAX+

APR Industries, Inc.
Boonton, NJ
800-729-2674
Fax: 201-335-3008

Arrow Lock Mfg. Co.
Brooklyn, NY
800-233-0478
Fax: 718-649-9097

ASSA High Security Locks
Brooklyn, NY
718-927-2772
Fax: 718-257-2772

Auto-Security Products (ASP, Inc.)
Redmond, WA
206-556-1900
Fax: 206-558-1205

Baldwin Hardware Corp.
Reading, PA
610-777-7811
Fax: 610-775-5567

Barry Supply Co./Div. of Barry Ind.
New York, NY
212-242-5200
Fax: 212-675-7094

Base Industries
Corona, CA
800-554-8088
Fax: 909-371-2828

Baton Lock & Hardware Co.
Garden Grove, CA
800-395-9484
Fax: 714-265-3630

Belwith International, Ltd.
Grandville, MI
800-235-9484
Fax: 616-531-6055

Bridgeman Security Equip.
Montebello, CA
800-334-6060
Fax: 213-727-0236

Brown Safe Mfg.
San Marcos, CA
800-698-2358
Fax: 619-744-4055

Calibro Corp.
LeMont, IL
800-915-2828

CCL Security Products
New Britain, CT
800-733-8588
Fax: 203-223-7601

Chicago Lock Co.
Chicago, IL
312-282-7177
Fax: 312-282-8199

Cor-Tech Mfg. Inc.
Luverne, MN
800-649-2252
Fax: 507-283-9081

Corbin Russwin Architectural
Hardware
Berlin, CT
203-225-7411
Fax: 203-828-7266

CorKey Control Systems, Inc.
Burlingame, CA
800-622-2239
Fax: 415-692-9410

Courtaulds Performance Films
Martinsville, VA
800-255-8627
Fax: 540-627-3032

Custom Security Products
Simi Valley, CA
805-522-5580
Fax: 805-522-9959

Cutler Mfg. Corp.
Lakeland, FL
800-237-2312
Fax: 914-646-4517

Deronde Products, Inc.
Buffalo, NY
800-346-8926
Fax: 716-895-9987

Detex Corp.
New Braunfels, TX
800-729-3839
Fax: 210-620-6711

Dom Security Locks N.A.
Brockville, Ont., Canada
613-498-9415
Fax: 613-498-5820

Door Controls Int'l.
Dexter, MI
800-742-3634
Fax: 800-742-0410

Doorguard Systems, Inc.
Columbia, MD
800-442-6247
Fax: 410-992-5694

Dortronics Systems, Inc.
Sag Harbor, NY
800-906-0137
Fax: 516-725-4234

Dudley Lock Inc.
Hemmingford, Que., Canada
800-363-1499
Fax: 514-247-3341

DuPage Products Group
Downers Grove, IL
800-323-7208
Fax: 708-969-0310

Dynalock Corporation
Forestville, CT
203-582-4761
Fax: 203-585-0338

Emtek Products, Inc.
City of Industry, CA
800-356-2741
Fax: 800-577-5771

Engineering Unlimited
Minneapolis, MN
800-515-4040
Fax: 612-522-2829 or 800-515-2829

ESP Lock Products
Leominster, MA
508-537-6121
Fax: 508-537-1699

Essex Electronics Inc.
Carpinteria, CA
800-539-5377
Fax: 805-684-0232

Exit Security Inc.
Fort Worth, TX
800-446-6775
Fax: 817-831-6063

Federal Lock Company
Romeoville, IL
800-682-9851
Fax: 708-378-4767

Folger Adam Company
Lemont, IL
708-739-3900

Fort Lock Corp.
River Grove, IL
708-456-1100
Fax: 708-456-9476 or 456-1197

Franklin Manufacturing/Div. of
Embassy
Farmingdale, NY
516-694-1800
Fax: 516-694-1836

Continued on page 104

Locking Products
Continued from page 102

GNI
Santa Rosa, CA
800-533-6423
Fax: 707-528-8085

GTO, Inc.
Tallahassee, FL
800-543-GATE
Fax: 904-575-8912

Guard Security Hardware
Brooklyn, NY
800-221-6895
Fax: 718-272-8335

Hammerlock Industries
Miami, FL
800-755-8345
Fax: 305-223-6097

Hampton Products International
Irvine, CA
800-562-5625
Fax: 714-472-9657

Hardware Technologies Ltd.
Ft. Atkinson, WI
414-563-2626
Fax: 414-563-4408

Harloc Inc.
Taylorsville, KY
800-5 HARLOC
Fax: 502-477-8831

Harrison Electronic Systems
Wilkes Barre, PA
800-422-5050
Fax: 717-823-6343

Hercules Industries, Inc.
Prospect, OH
800-345-2590
Fax: 614-494-2274

High Security - 777 USA Lock
Chandler, AZ
602-899-7770
Fax: 602-814-0000

Ilco Unican
Rocky Mount, NC
800-334-1381
Fax: 919-446-4702

Ilco Unican/Marlok Division
Winston-Salem, NC
800-849-8324
Fax: 910-725-3269

Illinois Lock Co./Div. of The Eastern
Co
Wheeling, IL
800-733-3907
Fax: 708-537-1881

Infographic Systems Corp.
Los Alamitos, CA
714-220-4980
Fax: 714-828-5763

Intellock Technologies
Pleasanton, CA
800-562-5875
Fax: 510-225-0600

International Locking Devices Ltd.
No. Branford, CT
800-863-9600

Intersek
Englewood, CO
303-871-1413
Fax: 303-788-1899

Jet Hardware Mfg. Corp.
Brooklyn, NY
718-257-9600
Fax: 718-257-0973

Kaba High Security Locks
Southington, CT
203-621-3601
Fax: 203-621-9727

Kenstan Lock & Hardware Co.
Huntington Station, NY
800-859-7874
Fax: 516-271-2759

Key Sales & Supply Co., Inc.
Detroit, MI
800-445-5397
Fax: 313-931-7758

Key Sure
New York, NY
212-219-0015
Fax: 212-219-0015

Keydex International Inc.
Oldsmar, FL
813-785-3535
Fax: 813-785-7627

Killeen Security Products
Worcester, MA
800-577-5397
Fax: 508-753-2183

Knox Company
Irvine, CA
800-552-5669
Fax: 714-252-0482

Kryptonite Corp.
Canton, MA
800-SAY-LOCK (729-5625)
Fax: 617-821-4777

Kwikset Corporation - A Black &
Decker Comp.
Irvine, CA
714-474-8800
Fax: 714-474-8862

KXL Corp.
River Grove, IL
708-453-1788
Fax: 708-456-9476

L&S Security Products
Gardena, CA
310-532-4988
Fax: 310-532-4988

L.J. Security Products
Pasadena, CA
818-242-3156

La Gard Inc.
Torrance, CA
310-325-5670
Fax: 310-325-5615

LAB Security
Bristol, CT
800-243-8242
Fax: 203-583-7838

Ladyfayre Holdings Ltd.
Calgary, AB, Canada
403-258-2588
Fax: 403-640-4215

Latch-Gard Co., Inc.
Wakarusa, IN
219-862-2373
Fax: 219-862-2459

Lee Electric, Inc.
West New York, NJ
800-433-3417
Fax: 201-866-0735

Liberty Hardware Mfg. Co.
High Point, NC
800-LIBERTY
Fax: 910-434-3364

Lindustries, Inc.
Auburndale, MA
617-237-8177

Lock Corporation of America
Viroqua, WI
608-637-8428
Fax: 608-637-8427

Lock Technology Corp.
New Rochelle, NY
914-632-4372
Fax: 914-632-6407

Lok-Itt Company
Solon, OH
800-735-0131
Fax: 216-349-2447

Lok-Safe Security Products
Miami Springs, FL
800-257-4196
Fax: 305-885-8800

Lori Lock
Southington, CT
203-621-3605
Fax: 203-621-5972

M.A.G. Eng. & Mfg. Inc.
Huntington Beach, CA
800-624-9942
Fax: 714-892-6845

Magnokrom, Inc.
Scarborough, Ont., Canada
416-299-0000
Fax: 416-299-3728

Major Manufacturing, Inc.
Atwood, CA
714-772-5202
Fax: 714-772-2302

Major Metalfab Inc. (MMF)
Wheeling, IL
800-445-8293
Fax: 708-537-1120

MARKS U.S.A.
Amityville, NY
800-526-0233
Fax: 516-225-6136

Mas Hamilton Group, Inc.
Lexington, KY
800-950-4744
Fax: 606-253-4748

Master Lock Company
Milwaukee, WI
414-444-2800
Fax: 414-449-3162

Maxfort Corporation
Baldwin Park, CA
818-813-9800
Fax: 818-813-0637

Maxim Technologies Inc.
Bronx, NY
718-548-9219
Fax: 718-548-9219

Maxton Security Systems
Sherman Oaks, CA
818-788-4466

Medeco Security Locks, Inc.
Salem, VA
800-548-8472
Fax: 703-380-5010

Megan Marie Creations, Inc.
Mequon, WI
800-4-KEY KIT
Fax: 414-242-1745

Meister Atlanta Corp.
Atlanta, GA
404-451-9700
Fax: 404-451-5305

Miwa Lock, Canada
Edmonton, AB, Canada
403-453-5226
Fax: 403-452-7551

Miwa Lock, USA
Las Vegas, NV
800-397-4631
Fax: 702-452-9330

Monarch Tool and Mfg. Co., Inc.
Covington, KY
800-462-9460
Fax: 606-261-7403

Mosler
Hamilton, OH
800-543-4584
Fax: 513-870-1071

MRL, Inc.
Springfield, VA
800-989-9891
Fax: 703-569-0196

Mul-T-Lock USA Inc.
Lodi, NJ
800-562-3511
Fax: 201-778-4007

Multi Lock Inc.
Ft. Lauderdale, FL
305-563-2148
Fax: 305-563-5644

Multi-Lock Corporation
Post Falls, ID
800-354-3284 x6543
Fax: 208-777-6402

National Cabinet Lock
Mauldin, SC
803-297-6655
Fax: 803-297-9987

New England Lock & Hardware Co.
S. Norwalk, CT
203-866-9283
Fax: 203-838-4837

New Standard Mfg. Co.
Las Vegas, NV
702-385-1132
Fax: 702-385-2615

Norden Lock Co., Inc.
Bohemia, NY
800-233-5625
Fax: 516-563-1742

Northeast Lock Corp.
Clifton, NJ
800-524-2575
Fax: 800-524-2576

OEM Mfg. Inc.
Hackensack, NJ
800-243-8636
Fax: 201-343-7315

Olympus Lock
Seattle, WA
800-525-0954
Fax: 206-523-9876

Omnia Industries, Inc.
Cedar Grove, NJ
201-239-7272
Fax: 201-239-5960

Pado Security Inc.
New Orleans, LA
800-523-9877
Fax: 504-486-6509

PDQ Industries
Leola, PA
800-441-9692
Fax: 717-656-6892

PEMCO Inc.
Ventura, CA
800-283-9988
Fax: 805-642-4109

Perry Blackburne, Inc.
Pawtucket, RI
800-556-7474
Fax: 401-725-7611

Phoenix Industries Inc.
Linwood, KS
800-238-3203
Fax: 913-723-3507

Positive Lock, Inc.
Russellville, AR
800-342-7670
Fax: 800-531-5293

Power Access Corporation
Collinsville, CT
800-344-0088
Fax: 203-693-0641

Precision Hardware
Romulus, MI
313-326-7500
Fax: 313-326-7540

Preso-Matic Keyless Locks
Sanford, FL
407-324-9933
Fax: 407-328-9977

Prestolock by CCL Security Products
New Britain, CT
800-216-0082
Fax: 203-223-7601

Pride Barco Lock Company
Santa Barbara, CA
800-578-1816
Fax: 805-965-2535

Prime Line Products Co.
San Bernardino, CA
800-255-3505
Fax: 909-880-8968

Qualtec Data Products, Inc.
Fremont, CA
800-628-4413 outside CA
Fax: 510-490-8471

Rutherford Controls, Inc.
Virginia Beach, VA
800-899-5625
Fax: 804-427-9549

S. Parker Hardware Mfg. Corp.
Englewood, NJ
800-S-PARKER
Fax: 201-569-1082

Safe-Gard Security Prod. Ltd.
Calgary, AB, Canada
403-258-2588
Fax: 403-640-4215

Safe-O-Mat Coin Locks
Edina, MN
612-927-6103
Fax: 800-733-7139

Salsbury Industries
Los Angeles, CA
800-323-3003
Fax: 213-232-7021

Sandstrom Products Co.
Port Byron, IL
800-747-1084
Fax: 309-523-3912

Sargent & Greenleaf, Inc.
Nicholasville, KY
606-885-9411
Fax: 606-885-3063

Secure-It-Inc.
E. Longmeadow, MA
800-451-7592
Fax: 413-525-8807

Securitech Group, Inc.
Maspeth, NY
800-625-LOCK
Fax: 718-392-8944

Securitron Magnalock Corp.
Sparks, NV
800-MAG-LOCK
Fax: 702-355-5636

Security Corner
Mansfield, TX
800-683-0696
Fax: 817-473-8088

Security Door Controls
Westlake Village, CA
818-889-1622
Fax: 800-959-4732

Security Latch
Cederville, MI
800-633-6622
Fax: 906-484-2761

Sentry Door Lock Guards
Dania, FL
305-922-1600

Sentrylok Corp.
Twinsburg, OH
216-425-1354
Fax: 216-425-1884

SeQwill Corp.
Barrington, IL
708-381-0730
Fax: 708-381-1676

Sibes Brass/Iseo Locks
Oxnard, CA
800-843-4951
Fax: 805-988-9493

Simplex Access Controls®
Winston-Salem, NC
800-849-8324
Fax: 910-725-3269

Slideline, Inc.
Oceanside, CA
800-545-0544
Fax: 619-945-8359

Source of Safety, International
Columbus, OH
800-421-9496
Fax: 614-421-0008

Star Key Industries, Inc.
Brooklyn, NY
718-821-8300
Fax: 718-821-8305

STAT Lock
Havertown, PA
800-286-7412
Fax: 610-872-6378

Steadfast Corporation
Chelsea, MA
800-342-5911
Fax: 617-889-2424

STRATTEC Security Corp.
Milwaukee, WI
414-247-3333
Fax: 414-247-3329

Suncoast Security Inc.
Largo, FL
800-441-2218
Fax: 813-585-2859

Supra Products, Inc.
Salem, OR
800-547-0252
Fax: 503-364-1285



SCHWAB CORP.

Fire protection for your vital records.

**It's not safe
unless it's
Schwab Safe.**

[Click here for more information](#)

MANUFACTURERS by PRODUCT

Locking Products continued

Tanner Bolt & Nut Corp.
Brooklyn, NY
800-456-2658
Fax: 718-434-3215

The Auth-Florence Mfg. Co.
Chicago, IL
800-275-1747
Fax: 312-384-3460

The Great Gate Lock Co.
Lancaster, PA
717-392-6284
Fax: 717-392-2919

Top Lock
Brooklyn, NY
800-972-0947
Fax: 718-434-4463

Trans Atlantic Co.
Philadelphia, PA
800-523-9956
Fax: 800-531-0844

Trine Products Company
Bronx, NY
718-829-4796
Fax: 718-518-7022

Tufloc
Canton, OH
800-321-0870
Fax: 216-452-2557

U-Change Lock Industries, Inc.
Mustang, OK
800-253-5625
Fax: 405-376-6870

Ultra Hardware Products
Pennsauken, NJ
800-426-6379
Fax: 800-858-7210

Valley Forge Security Products
Hauppauge, NY
800-645-5604
Fax: 516-435-1475

Valli & Valli (USA) Inc.
Duarte, CA
800-423-7161
Fax: 818-358-0743

Vigilante Burglar Bars, Inc.
Bronx, NY
718-328-3700
Fax: 718-893-7168

Vindicator
Austin, TX
512-314-1200
Fax: 512-314-1270

Weslock National, Inc.
Los Angeles, CA
800-575-BOLT (2658)
Fax: 310-324-4624

XL Lock Inc.
Orange, CA
714-282-2927
Fax: 714-282-8239

ZLock Mfg. Co.
Redondo Beach, CA
310-316-7709

Locksmith Tools

A-1 Security Mfg. Corp.
Richmond, VA
804-747-0095
Fax: 804-747-0534

Aable Locksmiths
Ozone Park, NY
718-847-1377
Fax: 718-847-0991

ABC Lock Co.
Council Bluffs, IA
712-366-4703

Acclaim Images, LLC
Midlothian, TX
214-296-6785
Fax: 214-296-7110

Active Technologies Inc.
Alamogordo, NM
800-545-5348
Fax: 505-434-6149

Adapt-A-Bore™
Milwaukee, WI
414-291-5684
Fax: 414-291-5685

Advance Car Mover Company
Juneau, WI
800-571-0136 ext. 64
Fax: 414-386-4416

Aero Lock
Memphis, TN
800-627-9433

All Safe & Security
West Allis, WI
800-310-3535
Fax: 414-546-6300

All-Lock Co., Inc.
Selma, AL
334-874-9001
Fax: 334-874-6011

Almont Lock Co., Inc.
Almont, MI
810-798-8950

America Key Boxes
Fl. Worth, TX
800-561-5397
Fax: 817-561-2881

American Saw & Mfg. Company
E. Longmeadow, MA
800-628-8810
Fax: 413-525-8224

Anderson Lock & Security
Chandler, AZ
602-821-2600

Baton Lock & Hardware Co.
Garden Grove, CA
800-395-8880
Fax: 714-265-3630

Bell Detection Mirrors
Brooklyn, NY
718-633-4000
Fax: 718-854-8909

Blackhawk Products
Dolores, CO
970-882-7191
Fax: 970-882-7228

Boggs Tool Processing & File
Sharpening Co.
Paramount, CA
800-547-5244
Fax: 310-634-0839

Commercial Van Interiors
St. Louis, MO
800-759-7477
Fax: 314-427-1525

Continental Micro, Inc.
Park Ridge, IL
708-692-3630
Fax: 708-318-6188

Corbin Russwin Architectural
Hardware
Berlin, CT
203-225-7411
Fax: 203-828-7266

Custom Security Products
Simi Valley, CA
805-522-5580
Fax: 805-522-9959

Darex Corp.
Ashland, OR
800-547-0222
Fax: 503-488-2229

Don-Jo Manufacturing
Sterling, MA
800-628-8389
Fax: 508-422-3467

Dremel
Racine, WI
414-554-1390
Fax: 414-554-7654

Dynabrade, Inc.
Clarence, NY
800-828-7333
Fax: 716-631-2073

Electro-Surgical Instrument Co.
Rochester, NY
716-235-1430
Fax: 716-235-1438

ESP Lock Products
Leominster, MA
508-537-6121
Fax: 508-537-1699

Fort Lock Corp.
River Grove, IL
708-456-1100
Fax: 708-456-9476 or 456-1197

Framon Manufacturing Company Inc.
Alpena, MI
517-354-5623
Fax: 517-354-4238

GT85 International, Inc.
St. Petersburg, FL
800-525-GT85
Fax: 813-526-1234

Henry A. Evers Corp.
Providence, RI
800-553-8377, 800-55-EVERS
Fax: 401-781-9581

High Tech Tools
Miami, FL
800-323-8324
Fax: 305-541-0074

Hill Security Products
Spokane, WA
800-722-1142

HPC, Inc.
Schiller Park, IL
800-323-3295
Fax: 708-671-6343

Ilco Unican
Rocky Mount, NC
800-334-1381
Fax: 919-446-4702

Intralock Tools Ltd.
Abbotsford, B.C., Canada
604-852-8904
Fax: 604-852-8938

Jensen Tools, Inc.
Phoenix, AZ
800-426-1194
Fax: 800-366-9662

Jon's Lock & Key
Sandy, UT
801-255-1003

JS Products Inc.
Las Vegas, NV
800-255-7011
Fax: 702-362-5084

Kaddies Inc.
Walnut Creek, CA
800-523-KADDIES
Fax: 510-934-4492

Keedex Manufacturing
Garden Grove, CA
714-636-5657
Fax: 714-636-5680

Keefe Mfg. Co.
Trenton, NJ
609-882-2290
Fax: 609-882-1698

Kent-Moore
Roseville, MI
800-345-2233
Fax: 800-578-7375

KEY-BAK: A Div. of West Coast Chain
Mfg. Co.
Onario, CA
909-923-7800
Fax: 909-923-0024

KeySoft Masterkey Software
Salt Lake City, UT
801-972-1369
Fax: 801-972-1369

Keystone Novelty Co. Inc.
Flushing, NY
718-544-1734
Fax: 718-544-1872

Kinduell Screen Printing
Wilders, KY
800-354-9877
Fax: 606-581-2322

Knaack Mfg. Co.
Crystal Lake, IL
800-456-7865
Fax: 815-459-9097

Kustom Key Inc.
Lake Havasu City, AZ
800-537-5397
Fax: 800-235-4728

LAB Security
Bristol, CT
800-243-8242
Fax: 203-583-7838

Ladyfayre Holdings Ltd.
Calgary, AB, Canada
403-258-2588
Fax: 403-640-4215

Lee Electric, Inc.
West New York, NJ
800-433-3417
Fax: 201-866-0735

LeRoy Edenburn Enterprises
Ypsilanti, MI
313-483-2444 or 313-483-6777
Fax: 313-485-8769

Liberty Hardware Mfg. Co.
High Point, NC
800-LIBERTY
Fax: 910-434-3364

Lindustries, Inc.
Auburndale, MA
617-237-8177

Lisle Corp.
Clarinda, IA
712-542-5101
Fax: 712-542-6591

Lock Technology Corp.
New Rochelle, NY
914-632-4372
Fax: 914-632-6407

Lock Technology, Inc.
Naperville, IL
800-421-7241
Fax: 708-983-5967

Lockmounts
Lancaster, KY
606-792-6526
Fax: 606-792-6526

Continued on page 108

**Locksmith Tools
Continued from page 106**

Locksoft, Inc.
Hastings, NE
402-461-4149
Fax: 402-461-4359

Major Manufacturing, Inc.
Atwood, CA
714-772-5202
Fax: 714-772-2302

Major Metallfab Inc. (MMF)
Wheeling, IL
800-445-8293
Fax: 708-537-1120

MDS (Medical Diagnostics Services
Inc.)
Brandon, FL
800-435-9352
Fax: 816-684-5953

Megan Marie Creations, Inc.
Mequon, WI
800-4-KEY KIT
Fax: 414-242-1745

Milwaukee Electric Tool Corporation
Brookfield, WI
414-781-3600
Fax: 414-781-3611

Mul-T-Lock USA Inc.
Lodi, NJ
800-562-3511
Fax: 201-778-4007

Numberall Stamp & Tool Co., Inc.
Sangerville, ME
207-876-3541
Fax: 207-876-3566

OEM Mfg. Inc.
Hackensack, NJ
800-243-8636
Fax: 201-343-7315

Olympus America Inc.-IFD
Melville, NY
800-446-5620
Fax: 516-844-5620

Pado Security Inc.
New Orleans, LA
800-523-9877
Fax: 504-486-6509

Paktek, Inc.
Tacoma, WA
800-258-8458
Fax: 206-589-1091

Panef
Milwaukee, WI
800-448-1247
Fax: 414-462-0980

PowerStar Products, Inc.
Sunnyvale, CA
408-774-6800
Fax: 408-774-6818

Pro-Lok
Orange, CA
714-633-0681
Fax: 714-633-0470

R&D Tool Co.
Albuquerque, NM
505-828-2664
Fax: 505-857-0642

R.J. Stuckel Co., Inc.
Elk Grove, IL
800-789-7220
Fax: 708-593-6027

Reading Body Works
Shillington, PA
800-458-2226
Fax: 610-775-3261

Ridgewood House
Middle Village, NY
718-894-3321
Fax: 718-894-2674

Rytan, Inc.
Torrance, CA
800-447-9826
Fax: 310-212-6002

Safe-Gard Security Prod. Ltd.
Calgary, AB, Canada
403-258-2588
Fax: 403-640-4215

Security Corner
Mansfield, TX
800-683-0696
Fax: 817-473-8088

Security Fastener Co.
Benicia, CA
707-746-8025
Fax: 707-746-0347

Sentry Security Fasteners
Peoria, IL
309-693-3800
Fax: 309-693-2872

Serr-Edge Machine Co.
Cleveland, OH
800-443-8097
Fax: 216-267-2929

Sibes Brass/Iseo Locks
Oxnard, CA
800-843-4951
Fax: 805-988-9493

Sieeking Products Co.
Rockford, IL
815-874-4030
Fax: 815-874-5713

Silca Keys U.S.A., Inc.
Twinsburg, OH
800-648-9239
Fax: 216-487-5459

Slide Lock Tool Co., Inc.
Louisville, TN
800-336-8812
Fax: 577-5936

Specialty Products Mfg. Co.
Plantsville, CT
203-621-6969
Fax: 203-621-6969

Steck Mfg. Co., Inc.
Dayton, OH
800-227-8325
Fax: 513-222-6666

STRATTEC Security Corp.
Milwaukee, WI
414-247-3333
Fax: 414-247-3329

Strong Arm Security, Inc.
S. San Francisco, CA
415-952-7710
Fax: 415-952-7710

Sully Tools, Inc.
Fairfax, VA
703-689-3416
Fax: 703-787-0869

Tag-It!
Kenmore, NY
800-627-2444
Fax: 716-447-9002

Tanner Bolt & Nut Corp.
Brooklyn, NY
800-456-2658
Fax: 718-434-3215

Tech-Train Productions
Pensacola, FL
800-356-0136
Fax: 904-476-7410

The L.S. Starrett Company
Athol, MA
508-249-3551
Fax: 508-249-8495

The M.K. Morse Company
Canton, OH
800-733-3377
Fax: 800-729-1112 or 216-453-1111

The Penetrator
Titusville, FL
407-267-0700

Tripp Lite
Chicago, IL
312-755-5400
Fax: 312-644-6505

Tufloc
Canton, OH
800-321-0870
Fax: 216-452-2557

Ultra Hardware Products
Pennsauken, NJ
800-426-6379
Fax: 800-858-7210

WD-40 Co.
San Diego, CA
619-275-1400
Fax: 619-275-5823

Young Bros. Stamp Works
Muscatine, IA
800-553-8248
Fax: 319-263-8003

Safes

A&B Safe Corp.
Chicago, IL
800-253-1267
Fax: 312-342-6694

Aanon/Safetron
Englewood, CO
303-781-1413
Fax: 303-783-0087

Adesco Safe Mfg. Co.
Paramount, CA
800-821-6803
Fax: 714-761-2846

Allied * Gary International
Waynesboro, GA
800-456-4279
Fax: 706-554-3319

American Security Prod. Co.
Fontana, CA
800-421-6142
Fax: 909-685-9685

Armor Safe Technologies
Vista, CA
800-487-2766
Fax: 619-598-5471

Bridgeman Security Equip.
Montebello, CA
800-334-6060
Fax: 213-727-0236

Brown Safe Mfg.
San Marcos, CA
800-698-2358
Fax: 619-744-4055

Buddy Security Systems
Chicago, IL
800-886-8688
Fax: 312-733-8356

Build-A-Safe Inc.
Huntington Beach, CA
800-248-7233
Fax: 714-572-9238

California Security Cans
Hermosa Beach, CA
800-848-0067
Fax: 310-372-2160

Cannon Safe Inc.
Pico Rivera, CA
800-242-1055
Fax: 310-692-7252

Cobalt Manufacturing Inc.
Denton, TX
817-382-8986
Fax: 817-383-4281

Conceal-A-Safe
Huntington Beach, CA
800-248-SAFE

Dayton Safe Company
Dayton, OH
513-461-3900
Fax: 513-461-4044

Empire Safes
New York, NY
800-543-5412
Fax: 212-941-9073

Envirotemp Corp./Frontier Safe Co.
Ft. Wayne, IN
800-861-6131
Fax: 219-744-6678

Escalera, Inc.
Yuba City, CA
800-622-1359
Fax: 916-673-6376

Gardall Safe Corp.
Syracuse, NY
800-722-7233
Fax: 315-434-9422

Granite Security Products, Inc.
Ft. Worth, TX
817-561-9095
Fax: 817-478-3056

Gun Vault, Inc.
Scottsdale, AZ
800-622-4903
Fax: 602-951-6844

Hamilton Safe Group
Pasadena, CA
800-634-7366
Fax: 818-796-1756

Hayman Safe Co., Inc.
Oviedo, FL
800-444-5434
Fax: 407-365-8958

Hide-A-Safe
Huntington Beach, CA
800-892-6275
Fax: 714-572-9238

Horizon Safe Manufacturing
Whittier, CA
800-624-7233
Fax: 310-945-4846

HPC, Inc.
Schiller Park, IL
800-323-3295
Fax: 708-671-6343

Hydrosorbent Co.
Ashley Falls, MA
800-448-7903
Fax: 413-229-8743

Ilco Unican
Rocky Mount, NC
800-334-1381
Fax: 919-446-4702

In-A-Floor Safe Co.
Cedar Glen, CA
909-337-9116
Fax: 909-337-8286

Continued on page 110

**Safes
Continued from page 108**

Indiana Cash Drawer Co.
Shelbyville, IN
800-227-4379
Fax: 317-392-0958

Innovative Moving Systems, Inc.
Oostburg, WI
800-619-0625
Fax: 414-564-2322

Intersek
Englewood, CO
303-871-1413
Fax: 303-788-1899

ISM/SPC - Israel Safe Manufacturing
Totowa, NJ
201-808-1233
Fax: 201-882-6625

Keedex Manufacturing
Garden Grove, CA
714-636-5657
Fax: 714-636-5680

Key Sales & Supply Co., Inc.
Detroit, MI
800-445-5397
Fax: 313-931-7758

Key Systems, Inc.
Rochester, NY
800-888-3553
Fax: 716-654-7916

Knight Safe Mfg.
Rancho Cucamonga, CA
800-USA-BILT
Fax: 909-483-3336

L.J. Security Products
Pasadena, CA
818-242-3156

Liberty Safe & Security Products, Inc.
Springville, UT
800-247-5625
Fax: 801-489-6409

Lifetime Products
Kewanee, IL
800-369-5365
Fax: 309-853-3389

Lund Equipment
Bath, OH
216-659-4800
Fax: 216-659-9347

McGunn Safe Co.
Chicago, IL
800-621-2816
Fax: 708-458-3323

Meilink Safe Co.
New Albany, IN
800-634-5465
Fax: 800-896-6606

Mini-Vaults
Huntington Beach, CA
800-892-6275
Fax: 714-572-9238

Mosler
Hamilton, OH
800-543-4584
Fax: 513-870-1071

Mul-T-Lock USA Inc.
Lodi, NJ
800-562-3511
Fax: 201-778-4007

Mutual Safe Co.
Springfield, MO
800-443-0731
Fax: 417-869-2625

National Security Safe Co.
American Fork, UT
800-544-3829
Fax: 801-756-8043

NKL Industries, Ltd., NKL Safe Co.
Chesapeake, VA
800-528-9900
Fax: 804-485-0271

Pacific Security Products Co.
Alhambra, CA
800-331-0785
Fax: 818-289-2326

Palmer Security Products, Inc.
Chicago, IL
800-788-7725
Fax: 312-267-8080

Perma Vault Safe Co.
Huntingdon Valley, PA
215-938-4300
Fax: 215-938-4310

Pride Barco Lock Company
Santa Barbara, CA
800-578-1816
Fax: 805-965-2535

Schwab Corp.
Lafayette, IN
800-428-7678
Fax: 317-447-8278

Security Corner
Mansfield, TX
800-683-0696
Fax: 817-473-8088

Telke Incorporated
Dover, DE
302-678-7800
Fax: 302-678-7809

U-Change Lock Industries, Inc.
Mustang, OK
800-253-5625
Fax: 405-376-6870

U.S. Security Safe Corp.
Los Angeles, CA
818-242-3156
Fax: 818-242-7638

Wilson Safe Co.
Philadelphia, PA
800-345-8053
Fax: 215-492-7104

Winfield Architectural Lock
Aventura, FL
800-938-7330
Fax: 305-937-7329

MANUFACTURERS by PRODUCT



**LOCKMASTERS
SECURITY
MANAGEMENT**

TM



**LOCKMASTERS
SECURITY
MANAGEMENT**

TM

*Click here
for more
information*

**Providing
quality tools,
parts, and
service
for the
security
professional.**



SCHOOLS

Acme School of Locksmithing
11350 S. Harlem
Worth, IL 60482
708-361-3750
Fax: 708-448-9306
Course Type: Resident
See ad on page 15

California Institute of Locksmithing, Inc.
14721 Oxnard St.
Van Nuys, CA 91411
Key Personnel: Charles Hasekian, President

Colorado Lks. College Inc.
4991 W. 80th Ave., Unit 103A
Westminster, CO 80030
Key Personnel: Howard Smith, President
See ad on page 21

Foley Belsaw Institute
6301 Equitable Rd.
Kansas City, MO 64120
800-821-3452
816-483-4200
Fax: 816-483-5010
Key Personnel: Tim Compton, Inst. Director
Course Type: Correspondence

Golden Gate School of Lock
Technology
3722 San Pablo Ave.
Oakland, CA 94608
Key Personnel: Edwin W.L. Scott Jr.

Granton Institute of Technology
263 Adelaide St. W.
Toronto, Ont. Canada, M5H 1Y3
416-977-3929
Fax: 416-977-5612
Key Personnel: Riyaz Misir, Information Officer
Course Type: Correspondence

L.T.C. Training Center
P.O. Box 3583
Davenport, IA 52808-3583
800-358-9393
319-322-6669
Fax: 319-324-7938

Key Personnel: Joe Schaechter, Dir. Mktg.
Course Type: Correspondence

Lock & Safe Institute of Technology

1650 N. Federal Hwy.
Pompano Beach, FL 33062
800-457-LOCK
305-785-0444
Fax: 305-783-4838
Key Personnel: Lew Jonas, Asst. Director
Course Type: Resident & Correspondence
See ad on page 45

Lockmasters
5085 Danville Rd.
Nicholasville, KY 40356
800-654-0637
606-885-6041
Fax: 606-885-7093
Key Personnel: Jo Ann Young, Educ. Admin.
Course Type: Resident & Correspondence

Locksmith School Inc.
3901 S. Meridian St.
Indianapolis, IN 46217
317-632-3979
Key Personnel: Jim Williams, Director
Course Type: Resident

Locksmithing Institute of America, Inc.
226 Fairfield Rd.
Fairfield, NJ 07004
Key Personnel: John P. Regan, President

Messick Vo/Tech Center
703 South Greer
Memphis, TN 38111
901-325-4840
Fax: 901-325-4843
Key Personnel: Steven L. Glass, Instr.
Course Type: Resident

North Bennett Street School
39 North Bennett St.
Boston, MA 02113-1998
617-227-0155

Fax: 617-227-9292
Key Personnel: Lillian DiGiorgio, Admiss. Office Mgr.
Course Type: Resident
See ad on page 47

Northern Metropolitan College of Tafe
Cnr. Bell St. & Waterdale Rd.
Heidelberg, West Victoria, Austr.
3081
613-9242-8670
Fax: 613-9242-8673
Key Personnel: Max Cherry, Locksmith Coord.
Course Type: Resident

NRI School of Locksmithing
4401 Connecticut Ave. NW
Washington, DC 20008
800-321-4634
202-244-1600
Fax: 202-244-2047
Key Personnel: Marc Jean-Michel
Course Type: Correspondence

Pine Technical College
1000 4th St.
Pine City, MN 55063
800-521-7463
612-629-6764
Fax: 612-629-6766, 612-629-7603
Key Personnel: John Heckman, CML, Instr.
Course Type: Resident
See ad on page 72

Prince George's Community College
301 Largo Rd.
Largo, MD 20772
301-322-0871
Fax: 301-808-0960
Key Personnel: Mary Oursler, Program Coordinator
Course Type: Resident

Professional Training Resources
PO Box 439
Shaftsbury, VT 05262
800-998-9400
802-447-7832
Fax: 802-447-7832
Key Personnel: Michael Carpenter, Owner

Red Deer College
Box 5005
Red Deer, AB, Canada T4N 5H5
403-342-3450
Fax: 403-342-3576
E Mail: bhemstreet@admin.rdc.ab.ca
Key Personnel: Brad Hemstreet, App. Chr.
Course Type: Resident

School of Lock Technology
1049 Island Ave.
San Diego, CA 92101
Key Personnel: Frank Hartung, Admin.

School of Lock Technology
302 W. Katella Ave.
Orange, CA 92667
714-633-1366
Fax: 714-633-0199
Key Personnel: Rick Rasmussen, Administrator
Course Type: Resident

The Academy of Locksmithing
2220 Midland Ave., Unit 106
Scarborough, Ont., Canada M1P 3E6
Key Personnel: E. Cole

Training Center
P.O. Box 3583
Davenport, IA 52808-3583
Key Personnel: Joe Schaechter

Universal School of Master
Locksmithing
3201 Fulton Ave.
Sacramento, CA 95821
916-482-4216
Fax: 916-485-9385
Key Personnel: Rick Vanina, President
Course Type: Resident & Correspondence

Valley Technical Institute
5408 N. Blackstone Ave.
Fresno, CA 93710
G. Haven Young, Dir. & Instr.

TNL

SCHOOLS

ALARMS

ADT Security Systems
300 Interpace Pkwy.
Parsippany, NY, 07054-1177
Key Personnel: Rick Bodge

Alarm Monitoring Services, Inc.
5021 Fairfield St.
Metairie, LA, 70006
800-228-4134
504-454-2163
Fax 504-456-8737
UL Certified
Key Personnel: Virginia L. Padua, Sales Mgr.
See ad on page 57

Amcest
1017 Walnut St.
Roselle, NJ, 07203
Key Personnel: Andrew Roberts

American Magnetics Corporation
740 Watson Center Rd.
Carson, CA, 90745-4181
Key Personnel: Richard Kelley, VP - Access Control

Central Alarm Control, Inc.
13973 SW 140 St.
Miami, FL, 33186
800-288-6522
305-238-0800
Fax 305-378-4563
UL Certified
Key Personnel: Robert Boudreaux, GM

Emergency Response Center
1514 E. 191st., Box 17154
Euclid, OH, 44117
800-322-3721
216-383-9506
Fax 800-243-3329
UL Certified
Key Personnel: Paul McNeil, Sales

Emergency 24, Inc.
4179 W. Irving Park Rd.
Chicago, IL, 60641
Key Personnel: Dante Monteverde, Pres.

Grand Central Station
23194 Kidder St.

Hayward, CA, 94545
Key Personnel: Mike Cooke, Mgr.

IDC
1301 E. 79th St.
Minneapolis, MN, 55425-1119
800-800-1600
612-854-7058
Fax 612-854-3342
UL Certified
Key Personnel: Raymond J. Menard, Mktg. Sales Mgr.

Monital Signal Corp.
1433 Highway 34
Farmingdale, NJ, 07729
Key Personnel: Ray Sacks, Pres.

N.A.C.C., Inc. (Nat'l Alarm Computer Center, Inc)
96 Corporate Parkway, Suite 300
Irvine, CA, 92714
800-482-9800
714-851-6222
Fax 714-253-7429
UL Certified

Key Personnel: Mark Schurbery, Director of Dealer Development

National Guardian Security Svc. Corp.
155 S. 5th Ave., Suite 550
Minneapolis, MN, 55401
800-333-5798
612-336-4360
Fax 612-333-8358
UL Certified
Key Personnel: Craig Leiser, VP Dealer Op.

Security Central
316 Park Drive, P.O. Box 5754
Statesville, NC, 28677
800-438-4171
704-872-9857
Fax 704-878-0309
UL Certified
Key Personnel: R. Courtney Brown, Jr./Operations Mgr.
See ad on page 119

TNL

ALARMS

ASSOCIATIONS

National

American Lock Collectors Assn.
36076 Grennada
Livonia, MI, 48154
Key Personnel: Charles Chandler

American Society for Industrial Security
1655 N. Ft. Myer Dr. #1200
Arlington, VA, 22209
Key Personnel: Susan Melnicove

Associated Locksmiths of America (ALOA)

3003 Live Oak St.
Dallas, TX, 75204
214-827-1701
Fax: 214-827-1810
Key Personnel: Charles Gibson, Jr.
Staff Admin.

See ad on page 19

Builders Hardware Manufacturers Assn.
355 Lexington Ave.
New York, NY, 10017
212-661-4261
Fax: 212-370-9047
Key Personnel: Gloria Boghosian,
Program Admin.

Institutional Locksmiths' Assn.
P.O. Box 810
Accokeek, MD, 20607
Key Personnel: Luke Dennis

Institutional Locksmiths' Association
PO Box 1275
Waldorf, MD, 20604
301-843-1595
Fax: 202-645-6530
Key Personnel: Philip A. Rovenolt.

Lock Museum of America
P.O. Box 104, 130 Main St.
Terryville, CT, 06786
203-589-6359
Fax: 203-589-6359
Key Personnel: Thomas Hennessy

National Burglar & Fire Alarm Assn.
7101 Wisconsin Ave, Ste. 901
Bethesda, MD, 20814
301-907-3202
Fax: 301-907-7897
Key Personnel: Jim Synk, Exec. Dir.

National Locksmith Automobile Assn.

1533 Burgundy Parkway
Streamwood, IL, 60107
Key Personnel: Marc Goldberg

National Locksmith Suppliers Assn.
1900 Arch St.
Philadelphia, PA, 19128
215-564-3484
Fax: 215-564-2175
E Mail: assnhgt@netaxs.com
Key Personnel: Patricia A. Lilly

National Safeman's Organization (N.S.O.)

1533 Burgundy Parkway
Streamwood, IL, 60107
Key Personnel: Marc Goldberg

Safe & Vault Technicians Assn.(SAVTA)
3003 Live Oak St.
Dallas, TX, 75204
Key Personnel: Maurice Jones

Security Industry Assn.
1801 K Street, NW, Suite 1203L
Washington, DC, 20006-1301
Key Personnel: John Galante

The Door & Hardware Institute
14170 Newbrook Dr.
Chantilly, VA, 22021-2223
Key Personnel: Richard M. Hornaday

Yankee Security Convention
P.O. Box 70
Medford, MA, 02155
Key Personnel: Lee Whitford

Arizona

Grand Canyon Chapter, ALOA
5007 West Pinchot
Phoenix, AZ, 85031
602-271-3362
Fax: 602-271-3327
Key Personnel: E. Kay White, CRL

Professional Assoc. Locksmiths of Arizona
29 W. Thomas Rd., Suite A
Phoenix, AZ, 85013
602-263-9777
Fax: 602-264-4122
Key Personnel: Roger McVey,
Sec./Treas.

California

California Assn. of Lock & Security Equip. Cont.
1100 N. Street #5F
Sacramento, CA, 95814
Key Personnel: Wayne D. Maris

California Locksmiths Association
1240 N. Jefferson St., Ste. G
Anaheim, CA, 92807
714-632-6800
Fax: 714-632-5405
Key Personnel: Kelly Ramirez, Exec. Dir.

LA/Orange Counties Chapter, ALOA
4009 Layman Ave
Pico Rivera, CA, 90660
Key Personnel: Wynn Kessler

Canada

Association of Ontario Locksmiths
2220 Midland Ave., Unit 106
Scarborough, Ont., Canada, M1P 3E6
416-321-2219
Fax: 416-321-2219
Key Personnel: Ray Lovett, Pres.

British Columbia Locksmith Assn.
637 Pine St.
B.C. Qualicum Beach, Canada, V9K 1J1
Key Personnel: George Hawkes

Professional Locksmith Assn. of Alberta
Box 68060 Bonnie Doon PO
Edmonton, AB, Canada, T6C 4N6
403-944-9229
Fax: 403-948-9997
Key Personnel: Dave Kennedy, Exec. Dir.

Colorado

Colorado Front Range, ALOA
7780 W. 88th Ave.
Arvada, CO, 80005
Key Personnel: Earl Mitchell

Rocky Mountain Locksmiths' Assn.
P.O. Box 2751
Denver, CO, 80201
303-347-8770
Fax: 303-347-8771
Key Personnel: Kent A. Smith, CPL

Western Slope Locksmiths' Association
306 N. 12th St.
Gunnison, CO, 81230
Key Personnel:

Delaware

Diamond State Locksmith Assn. of DE, Inc
P.O. Box 9536
Wilmington, DE, 19809-0162
Key Personnel: Ted Gula, Pres.

Florida

Central Florida Locksmiths Assn.
P.O. Box 204
Winter Park, FL, 32790
407-321-8600
Key Personnel: Kathy Reynolds, Pres.

First Coast Locksmiths Assn.
P.O. Box 26637
Jacksonville, FL, 32218
Key Personnel: William L. Hokanson

Florida East Coast, ALOA
P.O. Box 060238
Palm Bay, FL, 32906
Key Personnel: William Watkinson

Florida West Coast Locksmith Assoc.
3245 Bay to Bay Blvd.
Tampa, FL, 33629
Key Personnel: Carlton Babineau

Florida-Alabama Locksmith Assn.
6 Comet St., SW
Ft. Walton Beach, FL, 32548
Key Personnel: Roy Weeks

South Florida Chapter, ALOA
6414 Pembroke Rd.
Miramar, FL, 33023
Key Personnel: Donald Barraclough

South Florida Locksmith Assn.
P.O. Box 14322
Ft. Lauderdale, FL, 33302
Key Personnel: Christine Porter-Busch

State of Florida Board of Locksmiths Inc
P.O. Box 215
Sanford, FL, 32772-0215
Key Personnel: Kathleen Reynolds

Georgia

Dixie Locksmith Assn.
129 Sunset Lane
Albany, GA, 31705
Key Personnel: Sara Smith

Georgia Chapter, ALOA
P.O. Box 48088
Atlanta, GA, 30362
404-455-6244
Fax: 404-455-8080
Key Personnel: Buzz Whitman

Hawaii

Hawaii Chapter, ALOA
91-919 Ft. Weaver Rd., Suite 113
Ewa Beach, HI, 96706
Key Personnel: Thomas Carrion, Jr.

Iowa

Iowa Locksmith Assn.
125 School St.
Marion, IA, 52302
319-377-4295
Key Personnel: Kenneth Novey

Illinois

Greater Chicago Locksmiths Assoc.
6216 W. North Ave.
Chicago, IL, 60639
312-622-0944
Fax: 708-366-2094
Key Personnel: Kathy Zaniolo, Pres.

Illinois Locksmiths Assn.
71120 E. Park
Taylorville, IL, 62568
Key Personnel: William H. Pulley, CRL

Indiana

Central States Locksmith Assn.
6 Carol Ct.
Albany, IN, 47150
Key Personnel: David Kerr

Kyana Chapter, ALOA
903 Vincennes
New Albany, IN, 47150
812-948-2715
Fax: 812-948-2705
Key Personnel: Joe Corte, CML

Northern Indiana Chapter, ALOA
460 E. Main St.
Wabash, IN, 46992
219-563-1998
Key Personnel: John Boyer

Southern Indiana Chapter, ALOA
P.O. Box 133
Huntingburg, IN, 47542
Key Personnel: Lloyd Graham

Kansas

Great Plains Locksmith Assn.
706 Allen
Hays, KS, 67601
913-625-3969
Key Personnel: Elvis Hammerschmidt,
Pres.

Kansas Chapter, ALOA
706 Allen
Hays, KS, 67601
Key Personnel: Elvis Hammerschmidt,
CPL

Louisiana

Ark-La-Tex Locksmiths Assn.
P.O. Box 44337
Shreveport, LA, 71134-4337
318-222-8864
Fax: 318-221-8378
Key Personnel: Darlene Hays

Massachusetts

Massachusetts Locksmiths Assn.,
Central Group
P.O. Box 262
Worcester, MA, 01613
Key Personnel: Seth Deraerian

Massachusetts Chapter, ALOA
200 Weir St.
Taunton, MA, 02780
508-823-4649
Fax: 508-880-6385
Key Personnel: Robert Whitmarsh

Massachusetts Locksmiths Assn.
P.O. Box 2384
Woburn, MA, 01888
Key Personnel: Mario Lituri

Maryland

Locksmiths Assn. Wash DC Area, Inc.
10426 Fawcett St.
Kensington, MD, 20895
202-722-0900
Key Personnel: Lester S. Brodsky

Maryland Locksmith Assn.
P.O. Box 12398
Balto, MD, 21281-2398
301-236-4115
Fax: 301-384-6941
Key Personnel: Sheldon T. Finkelstein,
Pres.

Maine

Pine Tree State Locksmith Assn.
79 Chestnut St.
Lewiston, ME, 04240
207-784-5085
Fax: 207-782-2415
Key Personnel: Dick Vigue, Pres.

Michigan

Locksmith Security Assn.
19559 14 Mile Rd.
Clinton Twp., MI, 48035
810-791-5416
Fax: 810-792-4021
Key Personnel: Salvatore Dulcamaro,
CML

Southeast Michigan, ALOA
5504 Schaefer
Dearborn, MI, 48126
Key Personnel: George Guffey, Jr.

Minnesota Chapter, ALOA
14251 Fisher Ave., NE
Prior Lake, MN, 55372
612-894-1700
Fax: 612-894-1850
Key Personnel: David Dalby

Missouri

Gateway Locksmith Association
Box 63128
St. Louis, MO, 63163
314-865-2242
Key Personnel: Joe Clements

Missouri-Kansas Locksmith Assoc.
P.O. Box 11263
Kansas City, MO, 64119
816-842-3700
Key Personnel: Ray Luce, Pres.

Mississippi

Louisiana-Mississippi Locksmith Assn.
2314 Turkey Creek Rd.
Starkville, MS, 39759
601-324-2658
Key Personnel: Donald Rule, CML

Montana

Montana Chapter, ALOA
715 West Montana
Kalispell, MT, 59901
Key Personnel: Terry Weggeland

Montana Locksmith Assn.
1805 Highland
Helena, MT, 59601
Key Personnel: Ella Gaffaney

North Dakota

North Dakota Chapter, ALOA
1102 Main Ave.
Fargo, ND, 58103
Key Personnel: Todd Ladwig

North Prairie Locksmith Assoc.
83 S. Terrace
Fargo, ND, 58102
Key Personnel:

Nebraska

Nebraska Chapter, ALOA
3 Durwood Ln.
Hastings, NE, 68901
Key Personnel: Bradley N. Bouden

Nebraska Locksmiths Association
P.O. Box 145
McCook, NE, 69001
Key Personnel: Keith Delano, CPL

New Hampshire

New Hampshire Locksmiths Assn.
P.O. Box 831
Sommersworth, NH, 03878-0831
Key Personnel: Robert Wyman, II

New Jersey

Master Locksmith Assn. of New Jersey
P.O. Box 2441
Morristown, NJ, 07960
201-267-8884
Fax: 201-538-2248
E Mail: Aol - Maslock
Key Personnel: Nick Ambrosi, CPL

New Jersey Locksmiths' Assn.
P.O. Box 941
Piscataway, NJ, 08854
Key Personnel: Ray Favocci, Jr.

South Jersey Locksmith Assn.
334 Magnolia Rd.
Pemberton, NJ, 08068
609-894-0805
Fax: 609-894-2400
Key Personnel: Harry G. Pyett, Sec.

New Mexico

New Mexico Chapter, ALOA
4200 Wyoming Blvd., NE
Albuquerque, NM, 87111
Key Personnel: William Fadgen

New Mexico Locksmiths Assn.
10401 Delicado Pl., NE
Albuquerque, NM, 87111
Key Personnel: Steven Highland, CML

New York

Central New York Locksmiths Assn.
P.O. Box 566
Fulton, NY, 13069
315-287-0475
Key Personnel: Grant P. Mitchell

Nassau Suffolk Master Locksmith
Assoc.
112 Broadway
Amityville, NY, 11701
Key Personnel: Gregory Scala

New York Master Locksmiths
Association
1558 Second Ave.
New York, NY, 10028
212-535-2289
Fax: 212-988-9192
Key Personnel: Brian Star

Ohio

Ohio Valley, Chapter, ALOA
9178 Reading Rd.
Reading, OH, 45215
513-733-8988
Fax: 513-554-6032
Key Personnel: Toby Stafford, CRL

Oklahoma

Oklahoma Master Locksmith Assn.
415 Woodland Dr.
Midwest City, OK, 73130
Key Personnel: A.B. Parker

Oregon

Pacific Locksmith Association
P.O. Box 68
Dallas, OR, 97338
503-325-6003
Fax: 503-325-6003
Key Personnel: Stan Hauer, CPL

Pennsylvania

Greater Philadelphia Locksmith Assn.
P.O. Box 1101
Philadelphia, PA, 19136
Key Personnel: Bob Mock

Keystone Chapter, ALOA
P.O. Box 261
Eagleville, PA, 19408-0261
610-539-1206
Fax: 610-539-1206
Key Personnel: S. Thomas Hood, CML

Western Pennsylvania Locksmith Assn.
1009 4th Ave.
Coraopolis, PA, 15108
412-264-7221
Fax: 412-262-5625
Key Personnel: Leo S. Firanski

Rhode Island

Locksmith Association of Rhode Island
P.O. Box 9181
Providence, RI, 02940-9181
Key Personnel: Tom Pallottal, Pres.

South Carolina

South Carolina Locksmith Association
P.O. Box 264
Camden, SC, 29020
803-432-9008 or 432-8099
Fax: 803-424-0450
E Mail: Igriggs@scsn.net
Key Personnel: Jeanie Griggs

South Dakota

Wyoming Locksmith Association
521 Main St.
Spearfish, SD, 57783
605-642-4542
Fax: 605-642-4542
Key Personnel: Gene Ficek, CPL

Tennessee

East Tennessee Locksmiths Association
284 Brandonwood Dr.
Johnson City, TN, 37601
615-929-2451
Key Personnel: Larry Tipton

Middle Tennessee Locksmith
Association
P.O. Box 733
Antioch, TN, 37011-0733
Key Personnel: Ken Adams

Smokey Mountain, ALOA
P.O. Box 52923
Knoxville, TN, 37950-2923
Key Personnel: Marian M. Swann, CRL

Tri-State Locksmith Association
1261 Wellsville Rd.
Memphis, TN, 38117
904-685-1196
Key Personnel: John Singleton

West Tennessee Chapter, ALOA
1643 Bartlett Rd.
Memphis, TN, 38134
901-372-7464
Fax: 901-377-5576
Key Personnel: Pat Walker

Texas

Greater Houston Locksmiths Assoc.
P.O. Box 217
Lake Jackson, TX, 77566
409-297-2413
Fax: 409-297-1483
Key Personnel: Judy Clifford, Sec.

Greater Houston Locksmiths Assoc. Inc.
1100 Blackhaw
Houston, TX, 77079
713-493-4855
Fax: 713-293-7107
Key Personnel: Paul N. Cheatham III,
Pres.

Locksmith Association of San Antonio
P.O. Box 21156
San Antonio, TX, 78221
210-923-4381
Fax: 210-977-8398
Key Personnel: Wanda Robbins

Northeast Texas Chapter, ALOA
1106 S. Main, Suite 3
Duncanville, TX, 75137
Key Personnel: L.A. Parry

Texas Locksmith Association
2813-B East Southcross
San Antonio, TX, 78223
Key Personnel: Butch Titus

Vermont

Green Mountain Locksmiths Assn., Inc.
4 Renkin Dr.
Colchester, VT, 05446
Key Personnel: Dick Grant

The Locksmith Co.
4 Renkin Dr.
Colchester, VT, 05446
802-655-7450
Key Personnel: Richard Grant

Washington

Northwest Locksmith Assn.
702-189th St. Ct. E
Spanaway, WA, 98387-8342
206-846-1570
Fax: 206-846-2291
Key Personnel: Harold L. Harsfjord

Wisconsin

Wisconsin Locksmith Association
95124 W. Howard Ave.
Milwaukee, WI, 53220
Key Personnel: Dennis Jahnke

Wyoming

Wyoming Locksmith Assn., ALOA
1026 Alger Ave.
Cody, WY, 82414
Key Personnel: Allen McCumber



REPRESENTATIVES

Arizona

Randy Rehling
4175 Crocus Dr.
Phoenix, AZ 85023
602-938-1434
Fax: 602-938-1434
Key Personnel: Randy M. Rehling

California

A & M Sales, Inc.
P.O. Box 5098
Huntington Beach, CA 92615
714-549-5003
Fax: 714-549-7115
Key Personnel: Allan Oblath, Marsha Oblath, Treas. Cust. Svc.

Best Marketing Co.
2311 Elda St.
Bradbury, CA 91010
818-359-7579
Fax: 818-358-6840
Key Personnel: Dennis Daines

Brownell & Associates
P.O. Box 321, 14731-E Franklin
Tustin, CA 92681-0321
714-544-8003
Fax: 714-544-9301
Key Personnel: J. Michael Brownell, AHC Pres.

Cimaron Pacific
2795 Cherry Hills Dr.
Discovery Bay, CA 94514
510-634-3395
Fax: 510-634-7577
Key Personnel: John Bush, Owner

Coffman Associates
1531 Eagle Park Rd.
Hacienda Heights, CA 91745
818-810-7337
Key Personnel: Barry Coffman

Franken and Associates
20746 Elfin Forest Rd.
Escondido, CA 92029
619-744-0366
Fax: 619-744-0366
Key Personnel: M. Suzi Franken

Johnston & Dean
11923 Salem Dr.
Granada Hills, CA 91344
818-831-7788
Fax: 818-894-0280
Key Personnel: Ellen Johnston

Nicolai & Associates
108 N. McPherson Rd.
Orange, CA 92669-3721
714-538-5515
Fax: 714-538-9339
Key Personnel: Steve Nicolai, Pres.

Sprinkle & Associates, Inc.
2031 E. Cerritos Ave., Bldg. 7, Ste. 7B
Anaheim, CA 92806
714-491-9320
Fax: 714-491-9496
Key Personnel: Bill Sprinkle

Taurus Sales
400 12th St, Ste. 23
Modesto, CA 95354
209-549-0845
Fax: 209-549-0849
Key Personnel: Tim LeGree

Canada

The Lauderdale Sales Co.
1 Richview Rd., Ste. 1106-B
Etobicoke, Ont., Canada M9A 4M6
416-243-5354
Fax: 416-244-7765
Key Personnel: Barry Lauderdale

Colorado

Cofrank-Steele & Assoc. Inc.
2650 W. 2nd Ave., Unit 13

Denver, CO 80219
303-922-3692
800-321-7233
Fax: 303-922-8873
Key Personnel: Brad Steele, VP

The Florentine Co.
7694 W. Cool Mine Pl.
Littleton, CO 80123
303-973-4461
Fax: 303-973-4813
Key Personnel: Tony Florentine

Connecticut

Kevin Kelaher Associates
1317 Corbin Ave., P.O. Box 1928
New Britain, CT 06050-1928
203-224-9234
Fax: 203-826-1103
Key Personnel: Kevin Kelaher, Pres.

Florida

Rand-Mark Inc.
P.O. Box 5283
Ft. Lauderdale, FL 33310-5283
305-484-1284
Fax: 305-484-6345
Key Personnel: A. Hank Stern

Suncoast Marketing Assoc. Inc.
143 8th Ave. North
Safety Harbor, FL 34695
813-724-1916
Fax: 813-724-8206
Key Personnel: Mike Barnett

Georgia

Covil/Russom Associates
2289 Rushmore Dr.
Marietta, GA 30062
404-992-8725
Fax: 404-992-0776
Key Personnel: Mike Russom

S.B.S. Associates, Inc.
1530 Hillcrest Rd.
Norcross, GA 30136
404-923-9227
Fax: 404-923-9262
Key Personnel: Tom Southard

Illinois

A.J. Hildebrand Co.
137 N. Oak Park Ave., Rm. 401
Oak Park, IL 60301
708-383-2333
Fax: 708-383-1377
Key Personnel: Gary Hildebrand

Gene Simon, Hardware Specialist
P.O. Box 51
Flossmoor, IL 60422-1051
708-799-8783
Fax: 708-799-4322
Key Personnel: Gene Simon

Grotts & Associates
11727 S. Brightway
Mokena, IL 60448
Key Personnel: Tom R. Grotts

K-M Sales Inc.
P.O. Box 2082
Northbrook, IL 60062
708-564-1976
Fax: 708-564-5602
Key Personnel: Dave Shapiro, Pres.

Midwest Sales & Marketing Group
11258 Lakefield Dr.
Orland Park, IL 60462
708-479-2113
Fax: 708-479-2231
Key Personnel: Richard Stukus

Robert Perry Associates, Inc.
509 Lunt Ave.
Schaumburg, IL 60193-4422
708-894-1700

Fax: 708-894-3198
Key Personnel: Robert Perry, DAHC, CDL, CCS

Smith & Smith Sales Inc.
10336 S. Western Ave.
Chicago, IL 60643
312-238-5570
800-998-9399
Fax: 312-881-4258
Key Personnel: Robert Smith

Tri-Power Marketing
420 Appley Ave.
Libertyville, IL 60048-1929
708-680-9460
Fax: 708-680-0150
E Mail: elkajj@aol.com
Key Personnel: Lance Jensen

Kansas

Huntsman Representation Inc.
10 Beechwood
Hutchinson, KS 67504-0985
316-665-8780
Fax: 316-665-8780
E Mail: montero@ix.netcom.com or
seeker@datbank.com
Key Personnel: Wayne Huntsman

Massachusetts

Perlman Associates
P.O. Box 45 Accord Branch
Hingham, MA 02018
617-749-1840
Fax: 617-740-4647
Key Personnel: Ralph Perlman

Smoot Associates
P.O. Box T
Norwell, MA 02061
Key Personnel: Paul Smoot

Sterling Hardware Group
51 Union St., Union Pl., Suite 202
Worcester, MA 01608
508-770-9980
Fax: 508-770-9990
Key Personnel: Del Monroe

TED Associates
P.O. Box 73
S. Easton, MA 02375
508-238-8055
Fax: 508-238-8058
Key Personnel: Walter Elliott

Maryland

Advanced Hardware Consultants, Inc.
19600 Walter Johnsen Rd.
Germantown, MD 20874
301-353-1400
Fax: 301-353-1404
Key Personnel: Paul Frazier, AHC, Pres.

Bay Sales Co.
P.O. Box 86
Fallston, MD 21047
Key Personnel: Timothy Flanigan

Fallows & Associates Inc.
111 Warren Rd., Suite 13A
Cockeysville, MD 21030
410-667-4041
Fax: 410-667-6743
Key Personnel: Jeanie Fischer, VP Sales

JDL Associates
4941 Brampton Parkway
Ellicott City, MD 21043
410-750-2225
Fax: 410-750-1052
Key Personnel: Jeffrey Luther

Continued on page 116

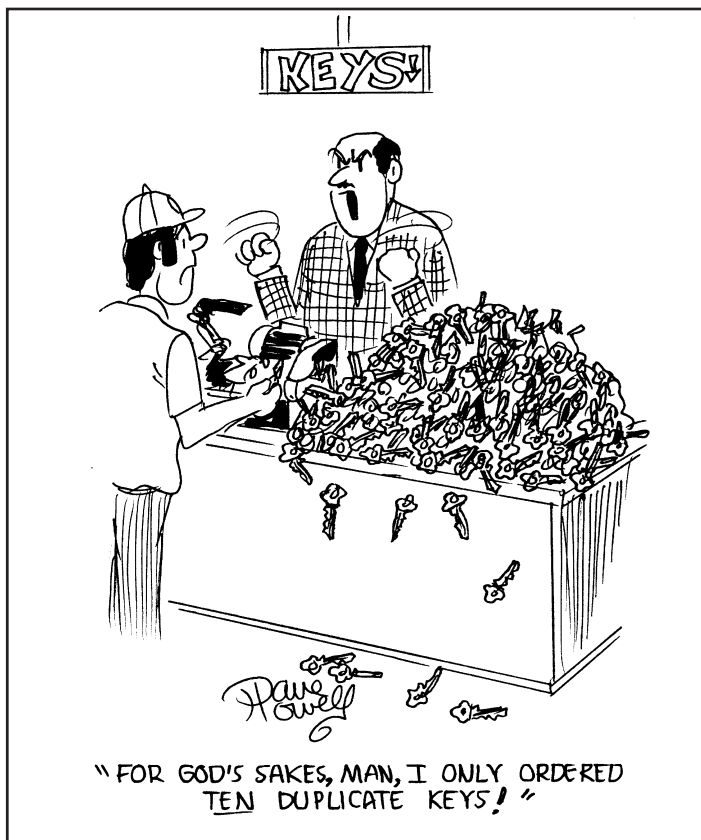

Continued from page 114

Patton Associates, Inc.
9057 Shady Grove Ct.
Gaithersburg, MD 20877
301-258-8844
Fax: 301-948-7707
Key Personnel: H.T. Patton, Jr.

Michigan

Gordon MacDonald Associates
725 S. Adams Rd., Ste. L61
Birmingham, MI 48009-6902
810-645-6250
Fax: 810-647-9687
Key Personnel: Gordon

Minnesota

HMR, Inc.
9065 Lyndale Ave. S.
Bloomington, MN 55420-3520
612-888-2122
Fax: 612-884-4768
Key Personnel: Zev Aelony, Mfg. & Rep

Kodo Associates Inc.
400 East 79th St.
Minneapolis, MN 55420-1253
612-881-1255
Fax: 612-881-6893
Key Personnel: Kodo Kawamura, President

M.R. Representatives
80 Transfer Rd., Ste. 32
St. Paul, MN 55114
612-659-0801
Fax: 612-659-0803
Key Personnel: Ken Minehan

North Carolina

Everett Dukes Associates Inc.
7517 Orr Rd.
Charlotte, NC 28213
704-596-6050
800-868-4256
Fax: 704-596-6060
Key Personnel: Everett E. Dukes, Jr. Owner

O'Neill Associates
2317 Cloister Dr.
Charlotte, NC 28211
704-366-7589
Fax: 704-365-6417
Key Personnel: T.B. O'Neill, DAHC, A.B.

Tsantes & Associates
9237 Kings Canyon Dr.
Charlotte, NC 28210
704-541-6398
Fax: 704-541-6397
Key Personnel: Keith J. Tsantes, Pres.

New Jersey

Dave McFadden & Associates
624 Holly Hill Dr.
Brielle, NJ 08730
Key Personnel: Dave McFadden

Herlo, Inc.
623 Eagle Rock Ave.
West Orange, NJ 07052
Key Personnel: Richard Unice

Koines & Alan, Inc.
P.O. Box 505
Chester, NJ 07930
908-879-7720
Fax: 908-879-7720
Key Personnel: Arthur J. Koines

Triad Associates
903 Teaberry Ln.
Brielle, NJ 08730
908-528-5658
Fax: 908-223-8396
Key Personnel: Dave Bryant

New York

CG Sales Company
2677 Terrell Ave., P.O. Box 233
Oceanside, NY 11572
516-766-6549
Fax: 516-536-5368
Key Personnel: Carmen Gagliano

Glezen Associates Inc.
13 Havens St.
Elmsford, NY 10528
914-592-3800
800-242-3389
Fax: 914-592-3813
Key Personnel: Robert Wolfskehl, Pres.

Michael H. Kaye
444 E. 82nd St.
New York, NY 10028
212-472-1573
Fax: 212-249-2134

Paul B. Moyer Agency
130 Bennett Rd.
Pine City, NY 14871
607-732-2738
Fax: 607-732-7997
Key Personnel: Paul B. Moyer

Tri-Star Sales
22 Tryon Ave.
Staten Island, NY 10312
718-948-6088
Fax: 718-966-7531
Key Personnel: Len Solomon

Ohio

Bockert & Associates, Inc.
1933 State Rd. 61
Norwalk, OH 44857-9762
419-663-2516
800-321-7550
Fax: 419-663-1588
Key Personnel: John Bockert, Pres.

Burson Brothers
24015 Bruce Rd.
Bay Village, OH 44140
216-871-5952
Fax: 216-871-5696
Key Personnel: Jack Burson

EGE
20728 Erie Rd., Ste. B
Rocky River, OH 44116
216-331-2868
Fax: 216-331-1790
Key Personnel: Ernest Green

Howard W. Murray Company
28901 Clemens Rd.
Westlake, OH 44145
216-835-9390
Fax: 216-835-3776
Key Personnel: Mike Murray

Lent & Associates
6591 Blackhawk Circle
Westerville, OH 43082
614-891-5535
Fax: 614-891-5577
E Mail: AOL lent g
Key Personnel: Gene Lent

Stanley Tepper & Co., Inc.
6405 Gates Mills Blvd.
Cleveland, OH 44124
216-461-6110
Fax: 216-461-1213
Key Personnel: Stanley Tepper, Pres.

Pennsylvania

Palmer & Golden Sales Inc.
706 Greystone Rd.
Wynnewood, PA 19096
610-649-1343
Fax: 610-649-0940
Key Personnel: Joel K. Golden

R.L. Larrabee Mfg. Agency Inc.
242 W. Montgomery Ave.
Haverford, PA 19041
610-642-0105
Fax: 610-642-0130
Key Personnel: Stephen Larrabee

Sporkin Associates Inc.
520 Abbott Dr.
Broomall, PA 19008
Key Personnel: Mel Sporkin, CDC

Texas

Clark & Schuck Associates, Inc.
2603 Southwell Rd., Ste. 103
Dallas, TX 75229
214-247-4692
Fax: 214-247-3606
Key Personnel: Don Clark

Galis Enterprises, Inc.
2104-A Roosevelt Dr.
Arlington, TX 76013
817-461-2079
Fax: 817-860-6999
Key Personnel: Martin Galis

H.L. Simon Company
1314 Huntington Dr.
Richardson, TX 75080
214-234-8009
Fax: 214-234-0339
Key Personnel: Laurence D. Simon, Pres.

Howard Sales Co.
4625 Ripley Dr.
El Paso, TX 79922
915-833-7733
800-456-4625
Fax: 915-833-7770
Key Personnel: Bill Uhlig, Pres.

Security Hardware Marketing Co.
14580 E. Bellwood Pkwy., Ste. 107
Dallas, TX 75244
214-960-2002
800-225-1481
Fax: 214-960-2029
Key Personnel: Tony Whitley, Jr.

Utah

Nelson & Associates
927 E. Millstream Way
Bountiful, UT 84010
801-295-0328
Fax: 801-295-4535
Key Personnel: Mel Nelson



REPRESENTATIVES



[Click here for more information](#)

HPC has it all:
Key Machines,
Software, Books, Car
Openers, Pick Sets,
Tools, Door Guards,
and Key Cabinets

YEAR END ARTICLE INDEX

YEAR END ARTICLE INDEX

Auto Service

	Month	Page
The 1995 Nissan Maxima	January	22
Making The Next Millenia	February	23
The 1994 Jeep Cherokee	March	32
The 1993 To 1995 Mazda RX7 Ignition	April	15
The 1995 Saturn	April	25
Mercedes	May	23
GM's VTD Passlock	June	11
Mercedes 190E, Part 2 Key Generation	June	24
Locking Up High Security Auto Work	June	76
Opening The Dreaded Contour/Mystique	June	107
The 15 Minute Ford 10-Cut Key	July	33
Catching The Wave: 1996 GM & Ford Locks	July	42
Honda's New Security Ignition	July	44
The 1994 Nissan Altima	August	24
1994-95 Honda Accord, Part 1	September	28
1994-95 Honda Accord, Part 2	October	29
Bypassing The On Guard Steering Wheel Lock	November	15
The 15 Minute Alpha Tech	November	30
The 1995 Celica, Part 1	December	132

Business/Marketing

	Month	Page
Real Time Service With EDI	January	44
Drive By Profits	February	36
Car Chasing	February	45
Beginner's Corner/Making Your Advertising Work For You	February	32
Viewpoint: Keys, Cars & Scams	March	8
Who's Cookin' With Padlocks?	March	62
Locksmithing Schools	April	57
No, I Don't Do Alarms	April	75
Lock In On Hotel Profits	April	87
Roadside Assistance The Ford Way	May	8
The National Locksmith Price Survey: 1995	May	103
Mail Lists, Marketing, & Making Money	May	109
Beginner's Corner/Computers	May	29
Viewpoint: Look, Leap, Look Out	June	10
Reader's Choice Awards	June	32
VIEWPOINT: A Matter Of Red Tape	July	16
5-Step Plan To A Van Interior	July	22
When Crime & Calls Don't Pay	July	47
All-Locked Up!	July	50
ALOA Exhibitor Listings & Booth Map	July	54
From Silver Keys To Silver Screen	July	114
Author's Vehicles	July	120
Talking Your Way To Cold Hard Cash	July	136
Lining Up Electronic Distributors	August	48
The Silent Partner	August	66
VIEWPOINT: Locksmithing Professional - A Definition	September	10
I Guarantee It - Safes	September	111
A Patent Battle: Best vs. Ilco	October	10
Beginner's Corner/Educate The Public	October	38
Don't Let The "T" Word Scare Ya!	November	11
How Does Your Lock Shop Add Up	December	120

Codes

	Month	Page
Codes: Kia Sephia	January	101
Codes: Millenia	February	90
Codes: Master	March	111
Codes: Master	April	109
Codes: Master	May	104
Codes: Motorcycle	June	118
Codes: Kawasaki & Suzuki Motorcycles	July	144
Yamaha Motorcycle and GM 10-Cut	August	101
1996 Ford Codes	September	122
Hudson H0001-H3000	October	96
Hudson, Part II	November	119

Electronic Security

	Month	Page
Wire Fasteners & Hangers	January	27
Headaches Of Mortar Filled Frames	January	34
Step In Time: Power & Strike Sequencing	January	40
The Shocking Reality Of Electronic Locksmithing	January	42
CCTV, Getting The Whole Picture	February	28

Through The First Door Of Access Control	February	ISC-6
CCTV-Just The Beginning	March	38
Four Factors In CCTV Selection	April	29
Same Skills, Less Time, More Profit	April	70
Unwinding The Mystery Of Recording	May	27
It's Elementary My Dear Watson!	May	42
Access Control Products	May	55
Switchers, Multiplexers And Other CCTV Magic	June	28
Markets, Demos & CCTV	July	36
Access & Institutions	July	84
CCTV For Every Locksmith	July	138
CCTV - The Site Survey	August	29
Wireless Electronics	September	34
Strike Three Equals A Home Run	September	96
All The Pieces: Wireless System Components	October	34
Planning The Wireless Installation	November	33
Electronics: New "Sideline" For Locksmiths?	November	38
Four Steps To Strike Selection	November	42
A Tale Of Two Locksmiths	November	46
A Facilities Locking System	November	52
Installing A Wireless Security System	December	136

Door Hardware

	Month	Page
Batten Down The Hatches	January	52
Concealed Closers Revealed	January	84
You & The ADA	February	47
ADA Product Gallery	February	49
Closers Under Foot	February	104
A New Heavy Weight Contender	April	50
Taming The Hardware Jungle	April	100
Going Keyless With The Keylex 2000	May	46
Hinging On Profits	May	64
Door System Profits	May	82
The Incredible Shrinking Locksmith	June	65
Safer Doors And Thicker Wallets	June	69
Dorma's ED 800	June	110
The Schlage S200 Interconnected Lock	July	28
The Schlage CL Series Cabinet Lock	August	44
Adams Rite Maglock Kit	August	51
The PG30 Sirenlock	September	25
Surface Door Closers, Part 1 - Applications	October	21
Close That Door!	October	58
Door Closers - Regular Arm Installations	November	24
Schlage's AL Series Lever	November	132
Closing The Top Jamb Installation	December	128

General Locksmithing

	Month	Page
High Security Locks: Medeco	January	16
Striking Applications	January	32
Doin' It With Best/Falcon	January	91
Locking Up The Problem Child	January	107
Beginner's Corner/Finding Correct Keys	January	30
The MIWA Attraction	February	17
Doin' It With Best/Falcon Part 2	February	51
When All Else Fails	February	ISC-9
Taming Troublesome Exit Devices	February	100
Corbin Russwin Emhart High Security	March	21
Puzzles, Padlocks & Profits	March	49
Bikes, Motorcycles & Trailers... Oh No!	March	54
Servicing The Medeco System Series Padlock	March	56
Beginner's Corner/Locking Up Pool Areas	March	48
The Schlage primus	April	23
I'll Huff & I'll Puff & I'll Kick Your Door In	April	38
Doin' It With Best/Falcon Part 3	April	59
Beginner's Corner/Rekeyable Master Padlocks	April	36
ASSA Twin 6000	May	18
Mul-T-Lock Telescoping Into High Security	June	18
Beginner's Corner/The American Series 6000 Padlock	June	31
Sentry's Portable Lock'r	July	20
Mirror, Mirror On The Wall	July	92
Why Dream For Power?	July	128
Beginner's Corner/A Tale Of The Multi-Lock Lock Bar	July	41
Well, It's About Chime!	August	15
Arrow J and K Interconnected Locks	August	20

High Rev Camlock Profits.....	August	34
Better Light On Security.....	August	ISC-10
Access Security For Small Businesses.....	August	ISC-12
Those Amazing Mullions.....	August	63
Avoiding Exit Alarm Errors.....	August	90
Beginner's Corner/ Basic Locksmith Tools.....	August	31
\$\$\$High Security\$\$\$.....	September	60
Find Security Weaknesses Before They Find You.....	September	8-ASIS
Grab On To Profitable Lever Lock Installations.....	September	75
Beginner's Corner/Cutting Code Keys.....	September	38
Common Solutions For Uncommon Problems.....	October	92
The Revolving Commercial Hardware Door.....	November	56
Playin' With Fire (Ratings).....	November	60
Say It With Accessories.....	November	90
Home Security And Threat Assessment.....	November	104
What Goes Around, Comes Around.....	November	108
Beginner's Corner/Make Garage Door Keys.....	November	37
Beginner's Corner/To Rekey Or Not To Rekey.....	December	140

Humor Month Page

The lighter Side/Smart Stuff.....	January	64
The lighter Side/No More Mr. Nice Guy?.....	February	62
The lighter Side/What They Don't Know.....	March	86
The lighter Side/A Learning Experience.....	April	68
The lighter Side/Safe And Secure.....	May	62
The lighter Side/Take Fifty-Six.....	June	74
The lighter Side/Ad-Ventures In Locksmithing.....	July	82
The lighter Side/Say What?.....	August	58
The lighter Side/I'll Never Forget Old Whal's-Her-Name.....	September	78
The lighter Side/Row, Row, Row, Your Boat.....	October	77
The lighter Side/Capping It Off.....	November	76
The lighter Side/Cause For Alarm.....	December	146

Key Machines/Tools/Equipment Month Page

The Great CLIP-OFF!.....	February	33
Lost In The Land Of Tools.....	February	40
Making The Cut In Aluminum Door Service.....	March	106
Stay Within The Lines.....	April	46
Field Accessories For Automotive Professional.....	April	104
The Second Monday Of This Week.....	May	30
Portable, Productive & Profitable.....	May	39
Punch Up Your Installations.....	August	40
Libby Does Machines.....	October	40
Let's Get Tubular.....	October	48
The Blue Punch Machine By Pro-Lok.....	October	56
Those Incredible Car Opening Tools.....	November	94

Safes Month Page

The LaGard Cable Channel.....	January	9
Mosler GSA Files, Part 1.....	February	8
The "Templanator".....	February	73
Mosler GSA Files, Part 2.....	March	10
Up In Smoke!.....	March	68
Fire Sale.....	March	74
Bovina Fire Sales: Avoid The Heat.....	March	81
Rethink Relockers.....	May	10
McOmie Vents His Spleen.....	May	67
Gun Safe Academics.....	May	96
Conceal A Safe.....	June	14
Electronic Safe Locks.....	June	106
Safe Moving The Smart Way.....	July	170
To Transfer Or Not To Transfer? That Is The Question!.....	August	92
Double Trouble.....	September	12
Punching For Profits.....	September	40
First Steps To Safe Penetration.....	September	51
Cash Cow Wall Safe Installations.....	September	55
That Cantakerous Stepper Motor.....	November	21
The S&G 6120 Electronic Lock Revisited.....	November	66
Dier-Diebold-Die!.....	December	160



Installation Tools The Professionals Choice

[Click here for more information](#)

How Does Your Lock Shop Add Up

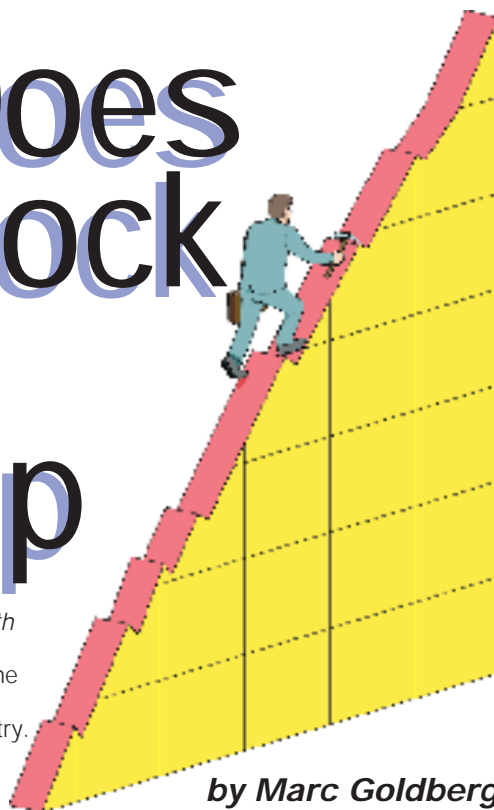

A real eye opener, *The National Locksmith* recently conducted a survey that yielded plenty of unexpected results. From income to shop size, take time to peruse and compare yourself to the rest of our industry.

by Marc Goldberg

Most of us know a great many locksmiths, spending our professional lives deeply involved in the security industry. But who really knows the locksmith best? Even after talking for many years to thousands of locksmiths, I have been reluctant to admit that there is very little statistical information available about the average locksmith.

Well, one thing I can guarantee you is that no locksmith is average. What I mean is that the nature of each business varies a great deal in terms of the business focus, number of employees and gross income. When you remember that some locksmiths focus on electronic security, some hone in on commercial work, and others seek out residential, it is plain to see that locksmith businesses will vary greatly in size and in nature.

Still, our industry has been crying out for many years for someone to take a closer look and try to develop some detailed information about what is typical for most locksmiths. Therefore, *The National Locksmith* has surveyed a random sampling of its subscribers to attempt to gain a deeper understanding of what the locksmith drives, what he earns and what his responsibilities are.

Do remember that this effort can best be described as a massive undertaking. It is not easy to get locksmiths to answer certain

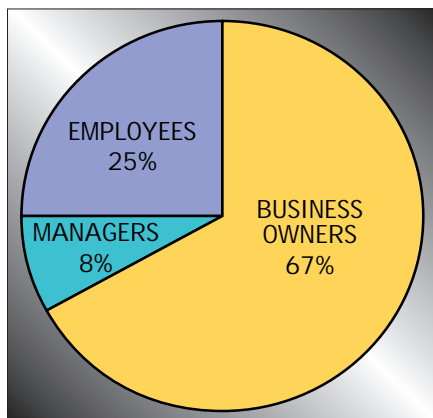

Chart 1. Survey respondents.

questions. For example, the questions about income were voluntary and not all locksmiths chose to answer this section. Moreover, there is no way to verify that those who did answer, gave exact indications of their income.

Still, this is an important first step in gaining further insight into your competitor's business as well as your own.

Those filling out the anonymous questionnaires for our survey broke down into three categories. (See chart 1.)

Since the surveys were addressed to paid subscribers of the magazine, it is also safe to assume that this is the same breakdown for job titles of our subscribers. Therefore, the vast majority of those reading *The National Locksmith* is the actual business owner himself. One would rightly expect that the owners have a large degree of responsibility for making purchasing decisions for their companies.

Illustrated in chart two are the types of responsibilities which exist regarding who makes the buying decision for a locksmith company. Remember that each locksmith surveyed was able to select *all* the responsibilities which he or she has.

You can easily see that those surveyed are largely responsible for determining which products their companies will buy. They then, further, largely have the authority for actually completing the purchase. This means that your fellow readers are very actively involved in the industry and in the management of their companies. Clearly readers of *The National Locksmith* are highly placed individuals within their businesses.

Within the locksmith industry there exists a wide number of kinds of businesses. Some locksmiths are strictly institutional, working directly for a hospital for example. Others work as retail locksmith business. While our survey did not attempt to define who was an institutional locksmith, we did break the industry down according to the following categories.

- Locksmiths84%
(This includes retail and institutional locksmiths)
- Security Consultants.....4%
- Commercial Security4%

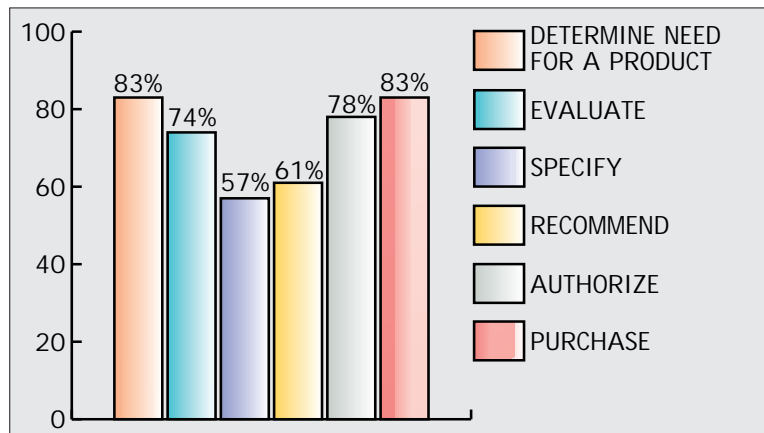

Chart 2. Purchasing authority of respondents.

Continued on page 122

Continued from page 120

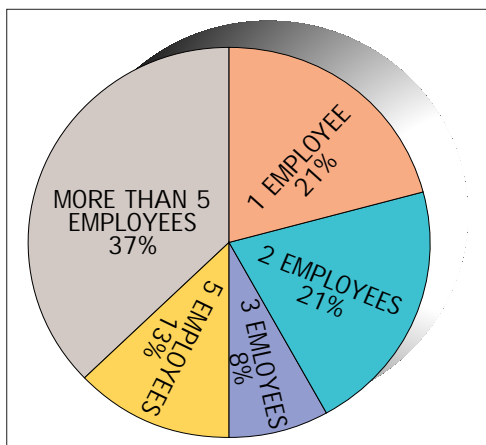

Chart 3. Average number of employees.

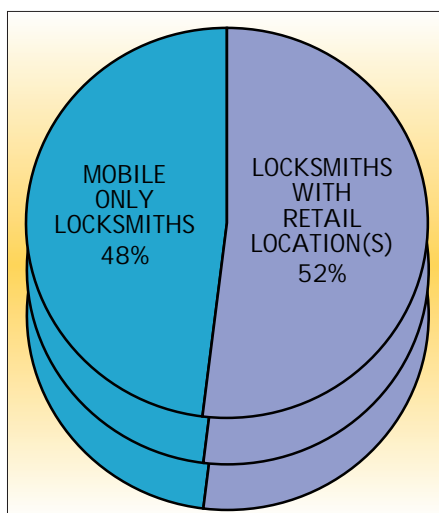

Chart 4. Mobile versus Shop.

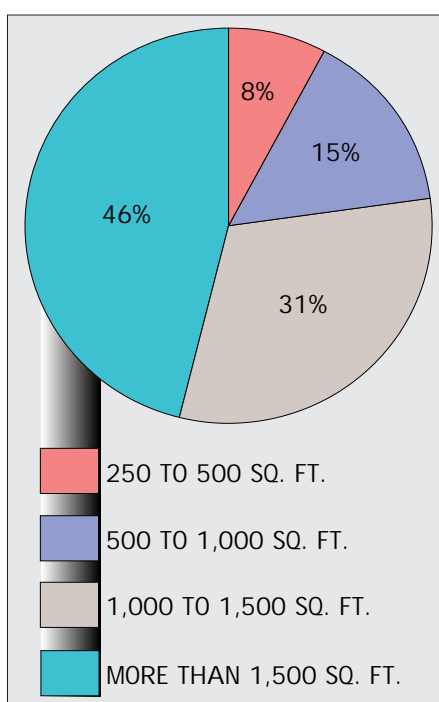

Chart 5. Shop square footage.

Government/Police4%
Other4%

Next, we asked locksmiths about the number of employees working for the company. The results were somewhat surprising to me. I had long assumed that most companies were one person proprietorships. However, the answers show that the average locksmith employs more people than just himself. This helps dispel the myth that locksmiths are simply all small time operators. If a locksmith employed only him or herself, that counts as one employee.

Chart three shows the breakdowns as to how many people the surveyed firms have on the payroll.

This means that fully 79% of those companies who were surveyed at random from among our readership employ two or more people. And a very healthy 58% employ at least three.

Another assumption that has long been made about the locksmith industry is that it is largely an industry composed of mobile-only locksmith businesses. And while our results do show a large number of locksmiths are strictly mobile, a very large percentage do have at least one retail location. (See chart 4.)

Of those locksmiths who do have retail space, the vast majority have only one location. However, a significant percentage do have multiple retail centers.

Locksmiths with one retail location 85%
Two retail locations 8%
More than two retail locations 7%

Next, we decided to gather information on the square footage of those locksmiths who do have retail space. I think the assumption has been that if a locksmith does have retail space, then he or she is crowded into quite a small store. This may have been true in the past. However, today's results reveal that a great number of locksmiths are displaying their wares in sizable locksmith shops, with professional layouts.

Chart five shows the breakdown for square footage:

It is easy to see that of those locksmiths who have retail locations, a huge percentage (77%) have got at least 1,000 square feet in which to operate.

Whether a company is mobile or retail based, the work is often out on the street. Thus, virtually every locksmith has one or more vehicle from which to conduct his operation. Once again, proving that locksmith businesses are larger than previously assumed, the respondents revealed to us the number of service vehicles owned by their companies. (See chart 6.)

Seventy percent of all those surveyed operate with more than one vehicle, and 57% utilize three or more service vehicles.

Locksmiths, being resourceful entrepreneurs, use a wide variety of vehicle types from which to run their businesses. I am acquainted with several locksmiths using unusual vehicles such as hearses, ambulances or motorcycles. Yet, the majority of services are run from more standard

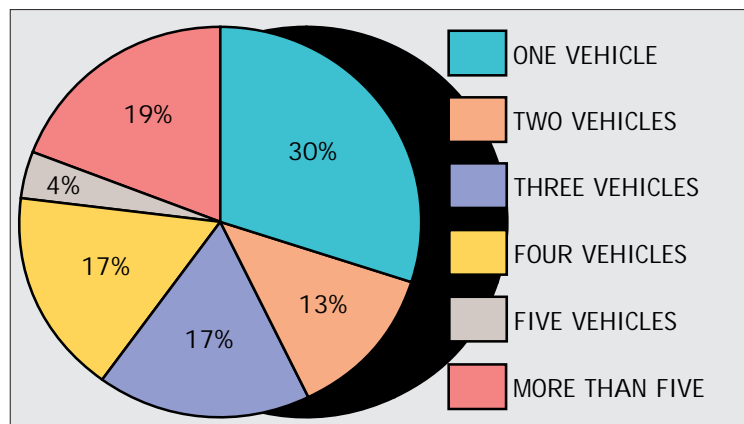

Chart 6. Average number of Service Vehicles.

types of four wheeled machines. Many companies use different kinds of vehicles within their fleet. Chart seven gives us the breakdown on the most common vehicles.

Of course, most locksmiths drive a good many miles per year due to the fact that they typically service a fairly wide territory. Wear and tear plus expanding fleets create the need to purchase new vehicles from time to time. Plus the intention to purchase a new vehicle within the next 24 months demonstrates a level of confidence in the economy. So we asked respondents how likely it is that

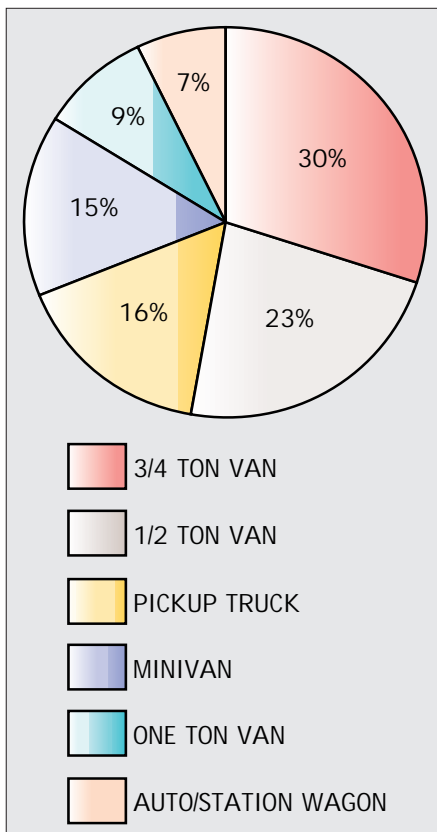

Chart 7. Vehicle types.

they will purchase a new vehicle within the next 24 months. This is reflected in chart eight.

The very high probability that most locksmiths will buy a new vehicle within the foreseeable future shows that as an industry, we are moving forward and continuing to prosper.

Another indicator of growth is revealed when we asked locksmiths to measure how likely it is that they will hire additional employees within the next 12 months. Results here were also promising, as we see that 52% of locksmiths surveyed consider it at least likely that within the next year, they will be adding to their staffs. (See chart 9.)

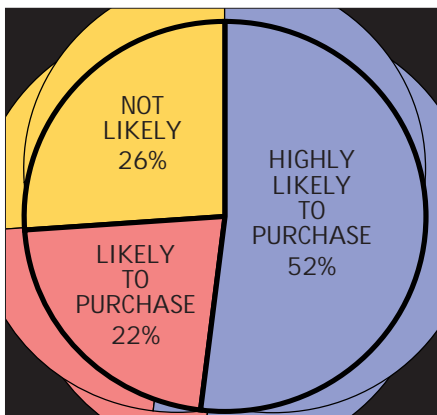

Chart 8. Intent to buy vehicle.



ASP - Your Auto Service Center for the World

[Click here for more information](#)

To most people, income is a highly personal area. However, we decided to plunge ahead and ask locksmiths to volunteer the amount of their gross sales in the last 12 months. Gross sales means we were asking for the total earnings of the company, before any expenses were paid, such as salaries and cost of inventory. Many locksmiths did choose to leave this question blank, but enough did provide the information to give an impression of locksmiths' earning power.

Under \$50,000 gross	5%
\$50,000 to \$100,000	30%
\$100,000 to \$150,000	20%
\$150,000 to \$200,000	5%
More than \$200,000	40%

Certainly, I am not quite sure that I believe that 40% of all locksmiths gross more than \$200,000 per year. Perhaps those who chose to actually answer this question were those in the higher brackets, and who felt prouder of their figures.

In any case, it does go to show, that many more locksmiths than ever

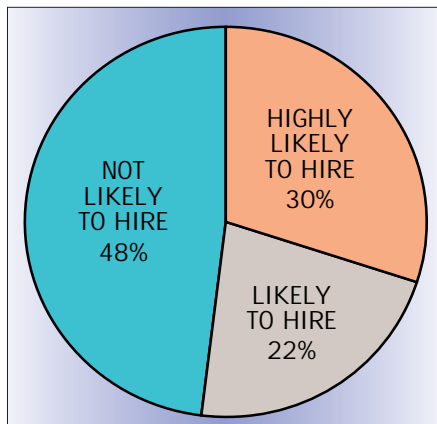

Chart 9. Intent to hire.

before are grossing large sums of money in their businesses. A \$200,000 gross would be considered quite small in many businesses. However, it is seen to be a high number in the locksmith industry. Clearly, readers of *The National Locksmith*, run the gamut of incomes, from large to small. Yet, more find themselves in the upper levels than previously thought.

Again, in order to gauge optimism, and track projected growth or decline in our industry, we asked locksmiths to guess at whether their levels of

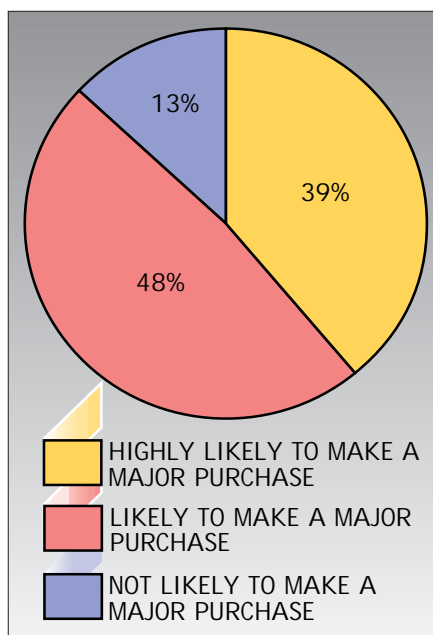

Chart 10. Likelihood to purchase.

business would grow, stay the same or shrink.

An amazing 77% of those surveyed demonstrate high levels of optimism by answering that they expect their sales to increase. Twenty-three percent said they expect their sales to remain where they are, and interestingly, none projected any shrinkage.

Growing businesses must purchase additional equipment in order to prosper. Therefore, we asked about plans for upcoming purchases of major equipment. We left it up to the determination of the surveyed locksmiths to decide what they believe constitutes a "major" purchase. We asked if the respondent's company planned to make such a purchase within the next twelve months, the results of which are shown in chart 10.

Presumably, falling into the "major purchase" category would be key machines, computers and other critical locksmith equipment, along with expensive tool sets.

Most locksmiths seem to rely on the Yellow Pages in order to advertise the businesses. Not surprisingly, 86% do place an ad of one size or another in the YP. Fourteen percent, however, choose to market through other methods.

Also, a large number of locksmiths either now, or in the past, have advertised in their local newspapers. Eighty-three percent have or do run

newspapers advertising, and 17% do not.

The following table shows all the various kinds of supplies and products a locksmith could theoretically purchase for his business. By percentage, we indicate how many locksmiths actively purchase within each product category.

Key blanks.....	86%
Locksmith tools	82%
Pinning kits	80%
Padlocks	75%
Deadbolts	74%
Key machines	68%
Knob locks	64%
Automobile locks.....	60%
Door and lock reinforcers	59%
Exit/panic devices.....	52%
Patio door locks	52%
Door closers.....	51%
Push button locks.....	49%
Window locks.....	49%
High security lock systems	41%
Safes.....	41%
Electronic lock products/access control.....	39%
Electronic locking devices.....	36%
Personal defense products	20%
One or more.....	91%

As you can see from having read the results of this article, a lot of interesting information reveals itself. Locksmith business run the gamut from small, sole proprietorships, all the way up to multi-location retail/commercial businesses.

Although there remain many areas to explore in future surveys, I think it is clear that the locksmith industry is a vital, thriving area of the economy. It is said that small business employ most of those who work for a living. And obviously it is fair to say that locksmiths do their part.

Any way you cut it, readers of *The National Locksmith* are busily making a living in their chosen profession, earning money, and spending what they must in order to grow their businesses. **TNL**

FireKing's Family Of Files

FireKing is Safe-In-A-File and Electronic Lock File are new members of Fire King's new Protection Plus family of files.



In addition to unique individual features, Safe-In-A-File and Electronic Lock File stand up to the most punishing conditions and share many of the same qualities built into each member of the Protection Plus family. Both models have been certified by UL standards and have been built to sustain temperatures of up to 1700°F, explosions of up to 2000°F and a drop from up to 30'.

FireKing Protection Plus Files feature an electrostatically applied powder coating to give them a scratch-, scuff- and stain-resistant finish. In addition, Protection Plus files feature a five-stage prefinishing treatment which provides unmatched adhesion and rust resistance. Both file models are available in nine colors: parchment, champagne, tan, sand, taupe, platinum, brown, pewter, black or any custom color. Interiors come in parchment and platinum.

If, for any reason, the consumer is not satisfied during the first year of ownership, FireKing will either replace it or refund the full purchase price. And if a

FireKing file sustains damage while protecting records from a fire, FireKing will replace it free of charge. Protection Plus Files also feature a lifetime parts warranty. As long as the original purchaser owns the file, FireKing will repair or replace any parts that malfunction or break at no cost to the owner.

For **FREE** Information
Circle 416 on Rapid Reply

Safer Image Defense Spray

For years the biggest complaint about civilian self-defense sprays is they may be taken from the potential victim, then used on them.

which also contains a practice unit, complete instructions and safety tips.

For **FREE** Information
Circle 417 on Rapid Reply

Yale 2100 Series Exit Device



Yale Security, Inc. introduces the 2100 Series Flatbar Exit Device designed for Grade 1 performance on

The 2100 Series device meets ANSI A156.3, Type 2, Grade 1 and carries UL1 and ULC fire exit labels.

A package of support accessories, including mullions and special strikes, completes the 2100 Series line.

For **FREE** Information
Circle 418 on Rapid Reply

Schlage's New AL-Series Levers

Schlage Lock Company introduced a new series of standard-duty, keyed levers engineered to raise the industry standard for strength, durability and styling of keyed lever locksets.

The new AL-Series features several strengthening components - such as a stainless steel interlocking spindle - that reinforce the lever against attack. The AL-Series, which comes in three lever styles, is designed for Grade 2 applications in office, medical, hotel/motel, retail, government and commercial facilities.



The AL-Series standard-duty keyed levers have threaded hubs and locking nuts that literally bolt the lock chassis to the door to prevent loosening. The heavy duty spring cages have true through-bolting outside the standard 2-1/8" door preparation - keeping the lock chassis from rotating inside the door and disengaging from the latch. Heavy duty compression springs give the levers fast return action and minimize drooping.

The new levers also incorporate a pending Schlage-patent door range adjuster which provides quick

**Security
Café**

**DROP IN FOR
TOOLS, TECHNOLOGY
& EQUIPMENT**



NO LONGER! The Safer Image has changed that by the introduction of a powerful five percent hot pepper blast that will immediately disable attackers but will not spray if taken from the victim's hand.

This unit comes in a kit

metal or wood doors industrial in applications.

Available in both rim and surface vertical rod applications for panic and fire exit doors, the 2100 Series offers sturdy construction with patented mechanisms made of heavily electroplated high grade steel and non-ferrous materials which also provide resistance to corrosion.

The device is available in baked powder coated finishes which offer excellent abrasion and rust resistance. A wide range of exterior trim is available in painted and plated finishes as well as stainless steel.

S E C U R I T Y C A F É

and easy adjusting for different door thicknesses.

For **FREE** Information
Circle 419 on Rapid Reply

Corbin Russwin's Key Management Software

The Corbin Russwin KC2000 key management software addresses key system security by providing the end user with the ability to track all keys issued. The program can accommodate up to 999 buildings (or areas, floors, tenants, etc. in single-building systems) and 9999 different key symbols within each building.

It is a user friendly IBM PC based package that operates as an electronic key cabinet, storing each unique key symbol by a building/hook number. Powerful search routines allow for quick retrieval of information on key holders and hardware, as



well as many other important details. Multiple fields can be searched simultaneously, by complete or partial information.

When used with a Corbin Russwin System 70 keying system, KC2000 can display and print the pinning of each cylinder in the system, including interchangeable core, master ring and high security cylinders. Except for this feature, all features of KC2000 can be used with other manufacturers' products. KC2000 is supplied on a low density diskette, with a choice of either 3.5" or 5.25" disk.

For **FREE** Information
Circle 420 on Rapid Reply

Alarm Lock's 250, 260, 700 & 710 Exit Locks



Alarm Lock Models 250, 260, 700 and 710 are today's most advanced high-value emergency exit alarms. All models, full panic bar or clapper plate versions, are equipped with a stainless steel deadbolt and deadlatch, meeting or exceeding all industry standards and relatching requirements for exit alarms. Each of these exit alarms feature a dual tone 95dB high volume blaring siren and have extended options for two minute or constant alarm. Alarm Lock's four units, the 250, 260, 700 and 710, feature the following as standard: audible low battery warning, 9 Volt battery and exterior key-control. The sleek architectural design of these exit alarms allow for an attractive look as well as easy-mounting. Plus, there are three diecast cover finishes to choose from, US28-Aluminum, or US312-Duronodic, or "new" A.L. Red.

For **FREE** Information
Circle 421 on Rapid Reply

Don-Jo Thimble Strike

Don-Jo has recently announced an addition to their strike category - Thimble Strikes. These are used with a deadbolt in a metal door and frame when there isn't enough room for a standard deadbolt strike. You only need to drill a 1" hole and pop the strike in place. There are flanged tabs located around the outside of the strike for holding power and we supply a 2" screw for extra security.

For **FREE** Information
Circle 422 on Rapid Reply

New Spacer By STI

A new spacer unit that helps eliminate fogging inside its Stopper® II device in out-of-door installations is being announced by Safety Technology International, Inc.

The new "Anti-Fog" Spacer (part STI 3155) is recommended when a Stopper II cover is installed out-of-doors over a manual pull station or other device containing heat-generating electronics. It solves the problem of fogging and condensation that can occur with a temperature inversion - as well as the resulting risk of a false fire alarm or malfunction of the fire alarm system.

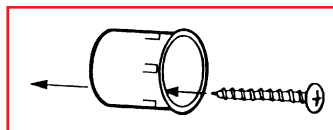

This spacer contains louvered air vents installed on each side near the top and a drain screen at the bottom for drainage of any collected moisture. Taylor emphasized the unit is not required on all Stopper II installations - only those where fogging or condensation may be a problem.

For **FREE** Information
Circle 423 on Rapid Reply

Door Sentry By Aiphone

Aiphone Intercom Systems introduces The Door Sentry, a new, lower cost, multi-featured Video Entry Security Intercom System. From a conveniently located room station, you can safely answer the entry door, identifying the caller by both sight and sound before opening the door. The Door Sentry's wide angle lens captures twice the area of other fixed camera systems, and has automatic backlight control to adjust for extreme sunlight and darkness. The Door Sentry is simple to install using the same wiring as a doorbell, easy to operate and very competitively priced.



Other system features include: Door release button for optional electric strike, monitor button to check the entry area undetected, two-stroke electronic door chime, optional second room station.

The boxed Door Sentry set includes a door camera, audio/video room station and power supply.

For **FREE** Information
Circle 424 on Rapid Reply

Lori Lock Adds Two New Keyways

With the addition of the Sargent RA-RC composite keyway, and the Yale GA, Lori Lock's total number of available keyways is now 29. The new keyways will be available in the entire line of mortise, insert, and rim cylinders. Lori has always prided itself in an extensive assortment of keyways. With the addition of the Sargent and Yale keyways, our company now offers more solutions for quality replacement cylinders than anyone in the industry.

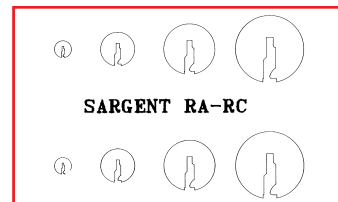

Lori Lock has always offered a one-stop solution for cylinders and keyways. Lori also manufactures a complete line of I.C. products in the Best "A" through "M" keyways.

For **FREE** Information
Circle 425 on Rapid Reply





GENERAL SECURITY

Test Article #106

Closing The Top Jamb Installation

by Randy Gockley

Locksmiths who do surface closer installations will encounter opportunities to work with top jamb applications. These applications owe their existence to the fact that they are well suited to outswinging exterior doors and offer a high degree of closer efficiency. The key consideration in such an exterior door application is protecting the closer from the elements. The top jamb application allows placement of the closer on the protected interior side of the opening. Top jamb mounts may not be the most desirable option in situations where vandalism is a potential problem, as the closer arm projects out and makes an inviting target.

Top jamb mount is very similar to regular arm mount, but the closer is turned upside down on the opposite side of the door. In this push-side application, the closer is installed on the face of the frame and the closer arm is installed on the face of the door.

From the standpoint of efficiency, this application is nearly as good as regular arm mount, though top jamb installations may involve reveal conditions that require the use of a longer arm to compensate for the added distance from the face of the door to the face of the frame. This will in turn slightly reduce the efficiency of the closer.

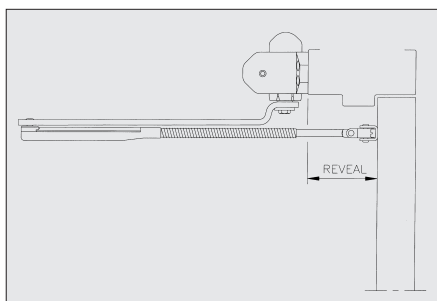

1. The reveal is probably the single biggest differentiation between a standard and top jamb mount. For the top jamb mount, a longer arm is sometimes needed.

In fact, allowing for push side reveal is one the most important factors differentiating top jamb and regular arm closer applications.

The first consideration on any top jamb installation is to confirm the reveal depth and make sure the correct arm length has been furnished with the closer. Reveal conditions will vary based on the door and frame type, size and material, though typical 5-3/4" or 5-7/8" depth hollow metal frames result in a 4" or greater reveal depths. (See illustration 1.) Arm designs vary from manufacturer to manufacturer. Most manufacturers supply extended length arms at no additional cost when ordered with the closer.

If the arm is not the proper length for the reveal condition it should not be installed. An arm that is too short will cause excessive preload that results in improper closer operation and can cause premature failure.

Assuming reveal conditions have been taken into account, the next step is to observe the entire opening, regardless of whether it is a new or retrofit job. As was mentioned in the previous article in this series, the survey should establish that the door is hung plumb and square, with no operational problems or binding. It is generally recommended that the doors be hung in a friction-free or minimal friction environment with ball bearing hinges or pivots. Any problems must be corrected first, before performing the closer installation.

Today, many retrofit installations are upgrades to comply with the Americans With Disabilities Act. The closer furnished must perform to the expected codes and requirements. If the installation involves a labeled fire door, the door must be self-closing and self-latching. The use of a standard hold open style arm is prohibited on these doors. In addition, most manufacturers recommend sex nuts or through bolts for the attachment of closers on labeled fire doors.

Building codes usually give precedence to the need for closing and latching fire doors over ADA-related barrier-free easy-opening concerns. Where these requirements are in conflict, it is often desirable to use a low energy power operator which can provide both barrier-free access and secure closing and latching.

A truly professional retrofit may require repair/repaint of the existing holes when the closer is not a direct replacement. The best installation will look unsightly if exposed holes are left unrepaired.

The door and frame must be sufficiently reinforced to accept the closer. Since the top jamb installation places the closer on the push side of the frame face, frame reinforcement is particularly important to ensure that the closer does not work loose and become a hazard. For more detail on reinforcement considerations, refer to the previous article on regular mount applications.

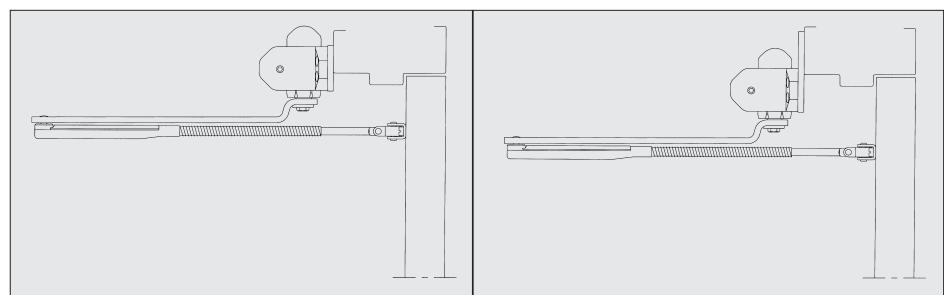

2. When necessary the use of a backplate or drop plate lowers the closer and arm down, providing better clearances when needed.

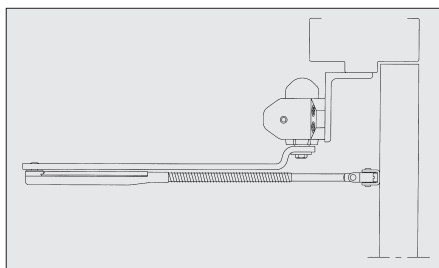

3. When door trim becomes a problem, an angle bracket may be necessary.

Consideration should also be given to the potential for conflict between the closer arm attaching screws and a concealed or surface applied stop and holder. A top jamb backplate or drop plate can be used to resolve this conflict. The drop plate typically provides more clearance. The plate is attached to the frame face, moving the closer and arm down. (See illustration 2.) This provides the mounting surface for the closer, which is attached to the plate with machine screws.

As was the case with a regular arm mount, bullnose or ornate trim can pose a problem. In this case, the trim would typically be located on the face of the frame where the closer would attach. Installers should resist the temptation to improperly mount the closer at an angle to avoid the uneven surface, as this can cause binding and premature wear of the arm and closer. While the trim or molding can be coped to fit around the closer, it is often easier and more aesthetically pleasing to use an angle bracket or to consider using a parallel arm mount instead. An angle bracket installation

locates the bracket in the push side rabbet or on the stop of the frame.

Corner brackets were often used in this application with the old "pot belly" closers. Angle brackets have now generally replaced the older corner brackets. (See illustration 3.)

The final pre-installation consideration is degree of opening. Mounting locations that determine the maximum degree of door opening vary from one manufacturer's products to another, but generally the nearer to the centerline of the door pivot or hinge the closer and arm shoe are mounted, the greater the degree of opening. The mounting location also establishes where the range of sweep, latch, backcheck and delayed action will occur. Deeper reveal conditions or wide-throw hinges can limit the maximum degree of door swing. If the desired degree of door swing cannot be achieved with the existing reveal condition, it may be necessary to use a different type mount, such as parallel arm.

Do not attempt to install the closer to serve as the limiting dead stop for the door. This typically results in premature damage and failure. Many manufacturers offer a specialty dead stop arm option for these situations. These special arms help limit damage to the closer .

Installation

For a successful installation, read all manufacturer's instructions, then remove all parts from the packaging, and check to be sure they are complete and undamaged. If all is in order, proceed as follows:

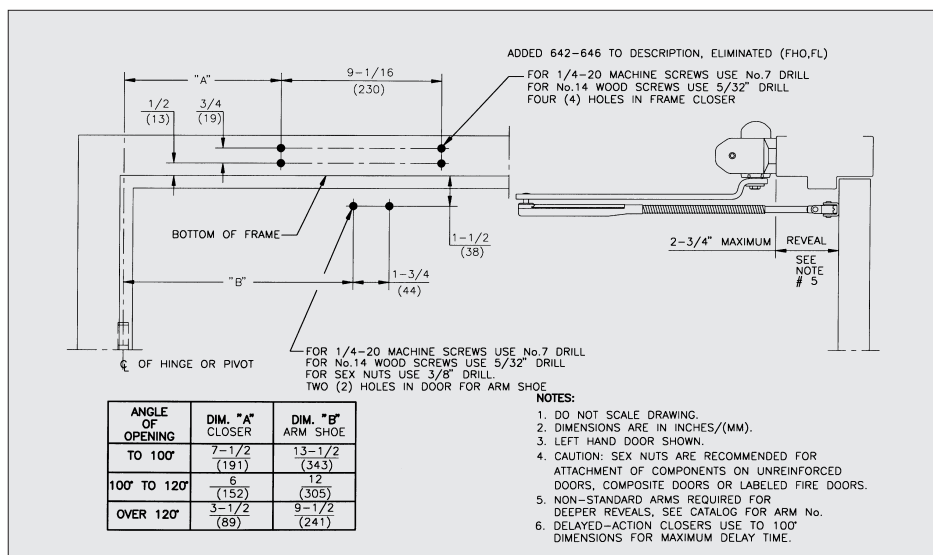

4. Closer installation does not involve guess work. Use the templates provided to correctly prepare the door and frame for the opener being used.

It's your reputation.



Trust the original.

[Click here for more information](#)

1. Determine the hand of the door. Drill and tap the door and frame to accept the closer. A machining template with appropriate dimensional details is usually part of the instruction sheet. (See illustration 4) Don't be creative. Closers are sophisticated products engineered for years of service, providing they are installed consistent with the dimensions furnished by the manufacturer.

Aluminum or hollow metal doors and frames typically have to be tapped to accept machine screws. As discussed above, sex nuts are recommended for attachment of components on unreinforced, composite or labeled fire doors.

2. If using a plate, install it. Mount the closer to the face of the frame or the plate. Normally, sweep and latch valves should be facing towards the hinges or pivots.

3. Separate the main arm from the connecting arm at the elbow.

4. Attach the main arm to the closer spindle, taking care to follow the indexing recommendations provided by the manufacturer. (See illustration 5.) Regular arm closers are normally installed with the main arm attached to the spindle perpendicular to the face of the door. Secure the arm with a washer and pinion screw.

5. Mount the arm shoe or foot to the face of the door, then attach the connecting arm on to the adjustment portion. (See illustration 6.) Some closers are furnished with an adjustable power shoe which can provide 15 percent additional closing power. In this case, mount the shoe with the pivot point toward the hinge edge of the door. Perform the

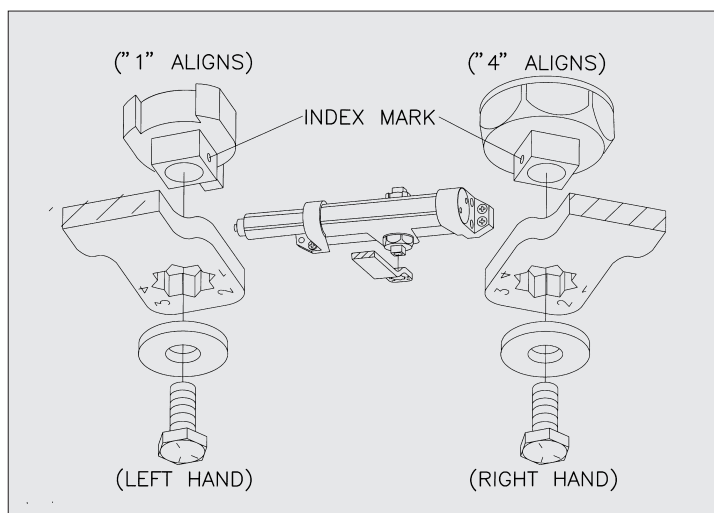

5. Attach the main arm to the closer spindle.

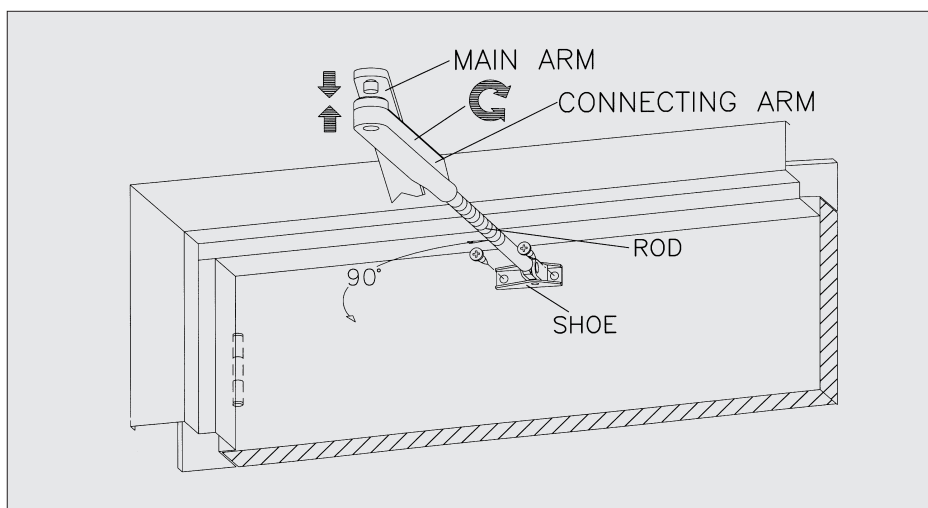

6. Attach the arm shoe to the door, make the necessary adjustments and connect the arm to the main arm.

appropriate adjustments and connect the connecting arm to the main arm. Typically, the main arm is preloaded slightly so that the adjustment arm is now perpendicular to the face of the door.

6. Open the door and observe the operation of the closer. Most manufacturers preadjust the closer in the factory, but it is still necessary to fine tune the adjustment to get optimal closer operation. Adjust the sweep speed (maximum opening to approximately 20 degrees) and the latch speed (20 degrees to closing), so that closing from 90 degrees will take approximately three to six seconds. Faster or slower closing speeds may be desirable depending upon the type and usage of the opening. A consistent, smooth closing cycle is most desirable.

7. Adjust backcheck and delayed action if furnished. Backcheck is the resistance provided by the closer to forceful opening. Delayed action is the delay or hesitation built into the closing cycle. Be sure that the backcheck is not set so strong that it is overly difficult to push open the door. When setting the delayed action, take into account the potential loss of heat or air condi-

tioning that will occur if the door remains open for too long.

8. Adjust the spring tension if required. As discussed in the initial article in this series, sizing is a function of the type of mount, the door width and whether the installation is on an interior or exterior door. Always reference the specific recommendation of the manufacturer when adjusting spring tension. After the spring adjustment is completed, again open the door to see if any modifications to the valve adjustments are required. (Some installers prefer to perform the spring adjustments prior to adjusting sweep, latch and backcheck. This is a matter of preference and will vary from installer to installer).

9. Pass through the opening, observing the door's function as it is used, and fine tune the adjustments. Observe all aspects of the door function to be sure the closer is performing reliably. It is better to spend a few extra minutes at this time than to later make a service call to readjust the closer.

10. Install the dust cap, and/or if the unit was furnished with a streamline or full cover, install them. Be sure they are securely attached, as a falling cover is a hazardous object.

Stand back. Admire your work, knowing the customer has received a professional service and product that will provide many years of trouble-free service.

The author is Technical Services Coordinator for DORMA Door Controls, Inc.



AUTOMOTIVE SECURITY

Test Article #107

The 1995 Celica, Part 1

by Michael Hyde

This month we take a look at the popular selling Toyota Celica. This model has a sleek and sporty look. (See photograph 1.) The keying kit for this model is ASP part number A-30-108 or A-30-150. This car uses the newer Toyota keyway and tumbler system, incorporating split tumblers. However, these tumblers use a different rule of thumb than most other brands using split tumblers. Since these split tumblers in the same space rest on the same cut flat of the key at the same time, they must always be the same depth. Therefore, it is not necessary to know which chambers use split tumblers to generate a key to this car. In other locking systems, such as your high-security sidewinder keys, the split tumblers ride on opposite sides of the



1. The 1995 Toyota Celica.



2. After carefully wedging the window back and use an Across-The-Car tool to flip open the lock button.



3. Using an Under-The-Window tool can also be used to open this vehicle.



4. The ignition is found in the dash and requires a key for removal.

medeco
HIGH SECURITY LOCKS

The market leader in locking systems for security, safety, and control.

[Click here for more information](#)

key allowing for different depths to be used.

This is a one key car, typical with most Japanese cars. This model also comes with a valet key to lockout using the trunk and glove box locks.

Opening The Car

I found this car can be opened a couple of different ways. The first way was to use what is commonly called an Across-The-Car tool. Remember to always take your time and do not force anything when working with glass. We used the tool to rotate the locking button to the unlocked position. (See photograph 2.)

The other way I found to open this car was to use an Under-The-Window tool. Take care when inserting and moving around this tool. I used a

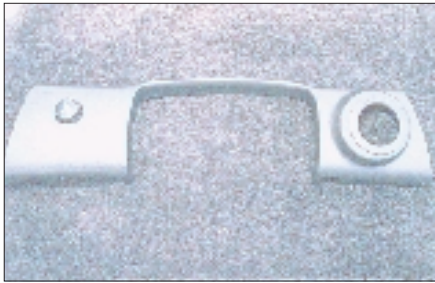

5. Removing the dash trim piece will expedite lock removal.



6. Remove the Phillips head screw and trim piece.

narrow version of this tool to rotate the locking button to the unlocked position. (See photograph 3.)

Ignition Lock

We start out servicing the ignition on this car. To remove the ignition cylinder lock it is necessary to have a working key. Without a key the lock must be picked or impressioned to remove it without destroying the lock. Both of these methods are difficult and impressioning is not recommended as this lock uses split wafers. If lock removal without a key cannot be accomplished, it will be necessary to drill, remove and replace the lock. (See photograph 4.)

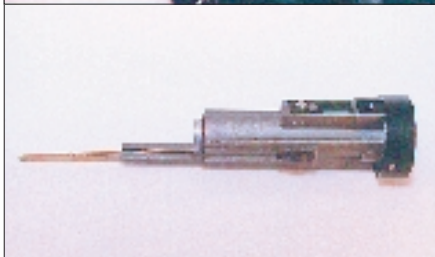

7. Depressing the retainer for lock removal.

To get to the cylinder more easily it is necessary to remove the plastic dash trim piece. This is accomplished easily by gently unsnapping it from the dash, and removing the wires attached to the dimmer switch located on the left side of the trim piece. (See photograph 5.)

Next it is necessary to remove the single Phillips-head screw that holds the plastic trim piece in place around the face of the lock. (See photograph 6.)

Now it is time to remove the lock cylinder, first insert the working key

and rotate it to the ACC position. Next insert an "L" shaped tool or probe with a 90 degree bend to depress the active retainer and pull outward on the cylinder for removal. (See photograph 7.)

To disassemble the cylinder you will have to first remove the Tru-arc snap ring mounted on the rear of the cylinder plug. (See photograph 8.)

There are two solid roll pins and one tension pin that must be removed in order to disassemble the cylinder face-cap of the lock. I usually drill next to the pins and then pry them out. An



*We have it all.
Quality, Value,
& Service.*

[Click here for more information](#)

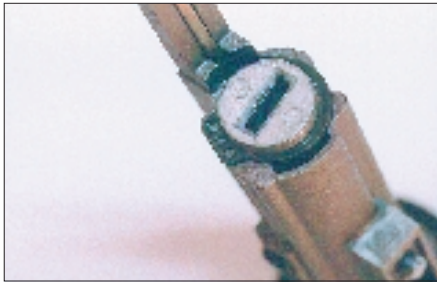

8. Remove the snap ring from the back of the plug.

alternative way for removing the side (solid) pins is to sharply hit the lock against a hard, covered surface. These

pins are loose and normally dislodge enough to grab with a pliers for removal. Make sure to use a block of wood or other covering to protect the lock's finish. If the black finish does become scored, use a black indelible marker to touch up the surface. (See photograph 9.)

Once the cylinder facecap is removed, the cylinder plug can be slid out of the housing. The cylinder plug contains all eight positions. Positions four and seven use split tumblers, the rest are all solid tumblers. (See photograph 10.)

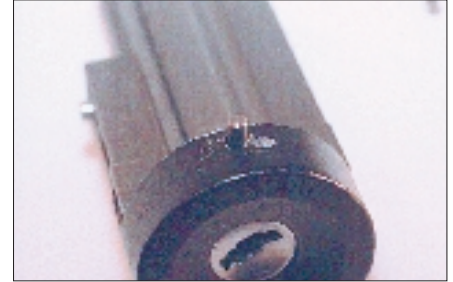
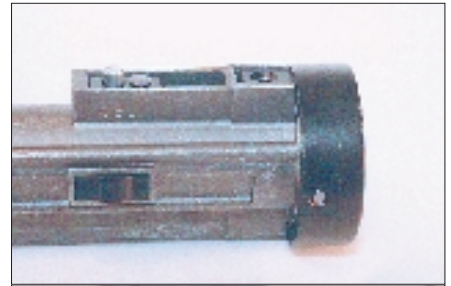

9. Remove the three roll pins and the facecap from the lock.



10. The plug can now be removed for service.

Next month we'll take a look at the rest of the locks and key generation.

TNL

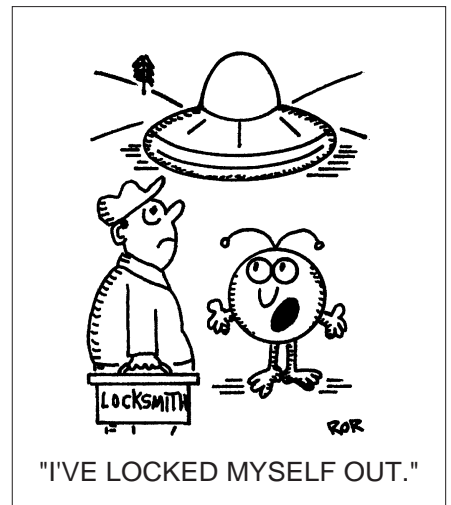

SRI
SECURITY
RESOURCES INC.

SRI and Steve Young are working together to bring you the best in locksmith tools and supplies.

[Click here for more information](#)



ELECTRONIC SECURITY

Test Article #108

Installing A Wireless Security System

by Joe Moses, Ph.D.

This article describes installation of a basic wireless security system. The planning checklist below is an overview of the steps to a successful installation:

- Mount the panel
- Connect the phone cord to the panel
- Connect the panel to the incoming phone line
- Install touchpads



1. The design of the Commander 2000 panel simplifies installation. Use the panel's mounting slots to mark the location of mounting screws. A level ensures proper mounting of the control panel. Once the panel's upper mounting screws are in place, hang the panel, and mark the location of the lower mounting screws.

- Connect transformer to the panel
- Apply power to the panel
- Program the panel

Tools required:

- 22-gauge 2- and 4-conductor wire and wire stripper
- A phillips and a flat head screwdriver
- Drill and a variety of bits
- Digital voltmeter
- Weatherproof crimp connectors and a crimping tool

Mount The Panel

During the planning phase of the installation you found a centralized, temperature- and humidity-controlled location on the premises with access to an incoming phone line and 110 VAC power. It is here we will install the control panel. For our demonstration, we are using the Commander 2000 alarm system by ITI.

To mount the Commander 2000 panel:

1. Remove the battery door and battery bucket
2. Hold the panel upside-down against the wall at the desired height and location

3. Mark the location of the mounting holes. (See photograph 1.)
4. Drill two holes
5. Put inserts and screws in place
6. Hang the panel right-side up on the screws
7. Mark the lower mounting holes
8. Remove the panel and repeat step five
9. Mount the panel on the four screws and gently tighten down the lower screws

Connect The Phone Cord To The Panel

To provide optimum service to the user, the control panel needs the ability to override other phones in the event of an emergency. This overriding is called line seizure. The DB-8 Cord provided with the Commander 2000 is a phone cord with a modular plug. (See photograph 2.) The modular plug connects to the RJ-31X jack, which is connected via a 4-lead splice wire to the telephone company (Telco) protector block and the premises phones. The RJ-31X jack lets the user unplug the panel from the phone system if necessary. This

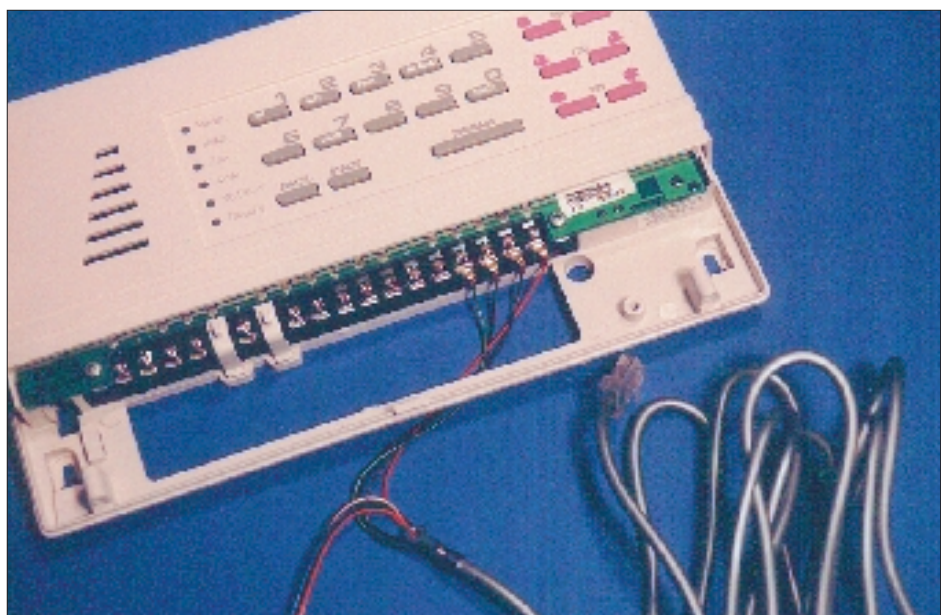

2. The Commander 2000 control panel is connected to the phone line via a DB-8 cord that connects to an RJ-31X phone jack.



3. The digital voltmeter indicates which Telco terminal is positive and which is negative. This 41.7-volt reading indicates that the bottom terminal (touched by the red lead) is positive. The -41.7 reading indicates that the red lead is touching the negative terminal.

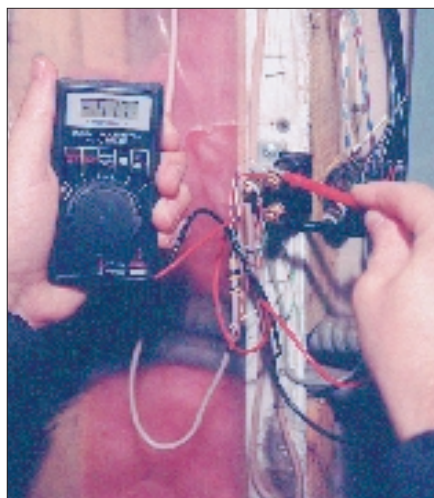

capability is required by many local ordinances.

To connect the panel to the phone line—

1. Connect the DB-8 cord to the panel making the following connections. (See photograph 2.)

Terminal #	15	16	17	18
Wire color	Green	Brown	Gray	Red

2. Wrap each end of the four extra wires with electrical tape to insulate them, and tape them together in case they are needed for future use.

Now is the time to check phone line polarity. Reversed polarity somewhere in the phone system is a common cause of phone problems. Checking phone line polarity before making connections reduces the risk of such problems.

1. Locate the Telco protector block where the telephone line comes into the premises.
2. Identify the positive terminal on the Telco block. To identify the positive terminal, use a digital voltmeter that measures DC volts. Connect the positive lead of the voltmeter to one terminal of the Telco block. Connect the negative lead of the voltmeter to the other terminal on the Telco block.

If the voltmeter displays a positive voltage, the positive terminal is connected to the positive lead of the voltmeter. Mark that terminal positive (+).

If the voltmeter displays a negative voltage, the positive terminal is connected to the negative lead of the voltmeter. (See photograph 3.)

Connect The Panel To The Incoming Phone Line

Use a length of 22-gauge 4-lead wire to make the connection between the RJ-31X jack and the Telco block and premises phones.

1. Locate the RJ-31X jack (CA-38A in Canada) within reach of the DB-8 cord.
2. Run a 22-gauge 4-lead splice wire from the Telco protector block to the RJ-31X jack.
3. Connect the splice wire to the RJ-31X jack as follows. (See photograph 4.)

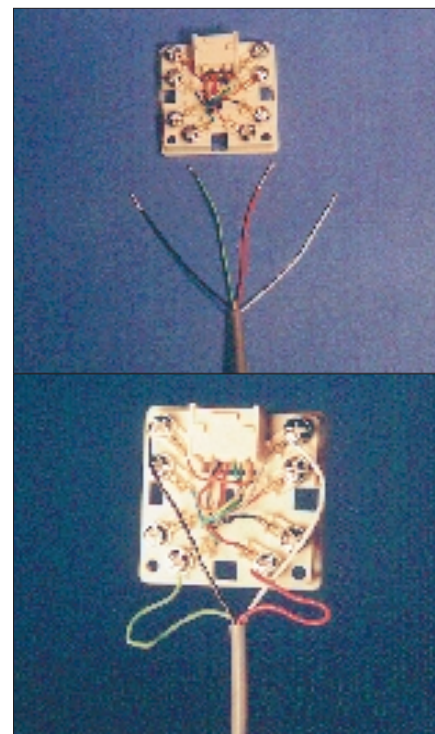

4. A 4-lead splice connects the RJ-31X phone jack to the Telco protector block. The splice wire connects to the phone jack as follows:
Splice wire black green red white
RJ-31X Jack brown green red gray

Splice wire black green red white (yellow)

RJ-31X Jack brown green red gray

4. Disconnect the Telco and premises phone lines at the Telco protector block. If there are multiple phone lines, keep the positive and negative leads grouped separately when you disconnect.



5. Use the voltmeter to determine which lines are Telco lines and which are premises phone lines. The 41.7 volt reading indicates the Telco line; the 136 millivolt (a fraction of a volt) reading indicates the premises phone line.



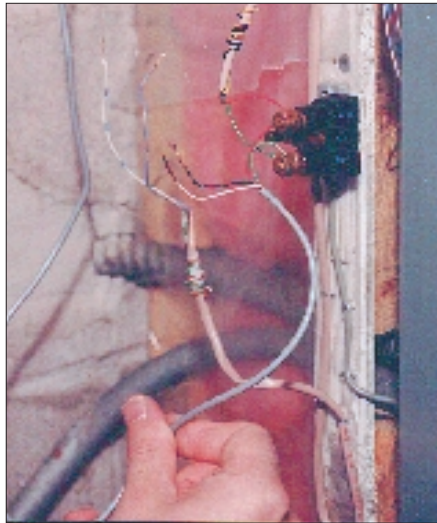

6. The splice wire's green lead and the Telco positive lead are connected to the positive terminal on the Telco block; the splice wire's red lead and the Telco negative lead are connected to the negative terminal.

5. If necessary, determine which lines are Telco lines and which are premises phone lines using a voltmeter (premises phone lines won't register any voltage; Telco lines will). (See photograph 5.)
6. Connect the splice wire's green lead along with the Telco positive lead to the positive terminal on the Telco block, and connect the splice wire's red lead along with the Telco negative lead to the negative terminal. (See photograph 6.)
7. Connect the splice wire's black lead to the premises phones' positive wires. (See photograph 7.)
8. Connect the splice wire's white (yellow) lead to the premises phones negative wires. (See photograph 8.)
9. Check all premises phones for dial tone and dial-out operation.
10. Plug the DB-8 cord into the RJ-31X jack.
11. Check all phones again for dial tone and dial-out operation. If the phones do not work properly, double check polarity and wiring.

Wire The Line Carrier Transformer

The Line Carrier Power Transformer supplies DC power to the panel. This transformer also transmits line carrier signals that operate the Wireless Interior Siren (WIS) and X-10 Lamp Modules.

1. Find an unswitched plug in the

basement or another unobtrusive location for plugging in the transformer.

Note: do not plug the transformer into the outlet at this time.

2. Connect a 22-gauge stranded 4-lead wire to the Line Carrier transformer and to the first four terminals of the control panel. (See photograph 9.)

Connect the same color wire to the same terminal numbers of the transformer and the panel. (If you connect the red wire to terminal one on the transformer, connect the other end of the red wire to terminal one on the panel, etc.)

Install Back-Up Batteries

CAUTION: See manufacturer's warnings about potential injury and equipment damage when installing batteries.

Place batteries (NiCd or Alkaline) in the control panel battery bucket. If you're installing NiCd batteries, be sure they are fully charged before installing them. Remove the appropriate plastic tab on the Commander 2000) consult manufacturer's instructions for other panels) to expose the correct screw terminal.

1. Connect the black wire from the battery bucket to terminal 6 (GRD) on the panel.

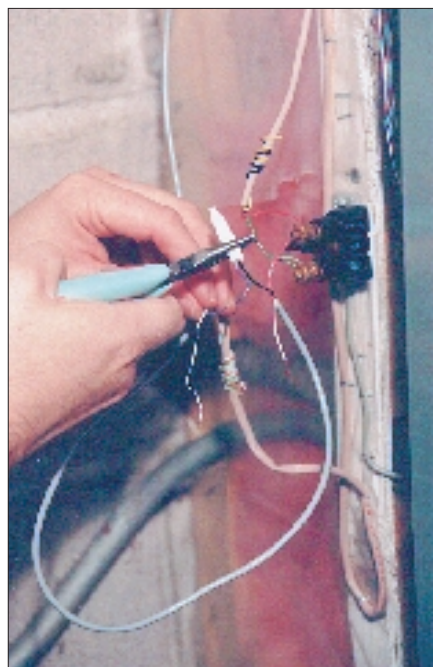

7. The splice wire's black lead is connected to the premises phones' positive wires.

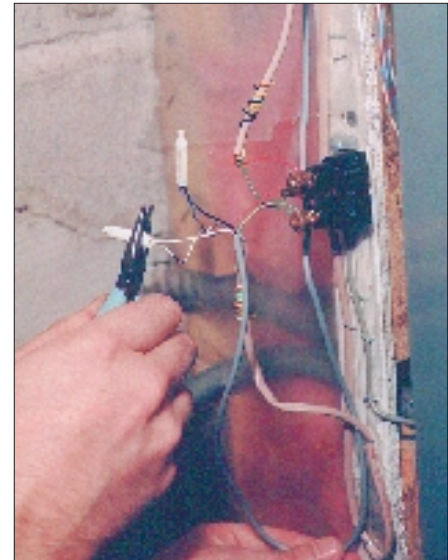

8. The splice wire's white (yellow) lead is connected to the premises phones negative wires.

2. Connect the red wire from the battery bucket to the appropriate terminal on the panel.

Connect Transformer To The Panel

After back-up batteries are properly installed, plug in the transformer to an unobtrusive plug that is not controlled by a switch. (See photograph 10.)

Program The Panel

The following guidelines explain the basic steps for programming a panel. For complete programming instructions, readers should attend manufacturers' training. The panel must be programmed to receive and recognize signals from sensors. Sensors monitor specific areas of the premises and communicate this



9. A 22-gauge stranded 4-lead wire is connected to the Line Carrier transformer and to the first four terminals of the control panel. Connect the same color wire to the same terminal numbers of the transformer and the panel. (That is, if you connect the red wire to terminal one on the transformer, connect the other end of the red wire to terminal one on the panel, etc.)



10. Plug in the line carrier transformer into an unobtrusive plug that is not controlled by a switch.

information to the panel, which responds with alarm sounds and status information.

1. Enter the program mode.
2. Enter the installer programming code (assigned by manufacturer.)
3. Clear panel memory.
4. Assign group numbers to all sensors.

Program The Sensors

The panel must be programmed to receive and recognize signals from sensors. Each wireless sensor has a unique sensor identification code (ID). Because each sensor ID is different, the panel has to learn the ID of each sensor in the system. To enter program mode—

1. Enter the primary access code + 1.
2. Loosen the screws on the battery door until the READY light turns off.
3. Enter the installer programming code (assigned by manufacturer).
4. Identify the sensors you will install and locate the group numbers that apply to each sensor's function.



11. Sensors come with a variety of mounting brackets. This is a corner-mounting bracket for a wireless PIR motion sensor.

5. Record group and sensor number assignments on the "Sensor Groups and Location" worksheet. Be sure to keep group numbers together, and assign sensor numbers sequentially within groups.
6. Use the stickers provided in the panel's accessory pack to identify each sensor when you mount them.
7. Press STATUS + (group number).
8. Enter the sensor number. Refer to your "System Planning Worksheet" for the sensor number that you planned for the system.
9. Trip the tamper switch of the sensor you are programming (usually by simply removing the cover. The panel learns the ID when you trip the sensor's tamper switch.
10. Repeat step 8 until the desired sensors are programmed in the current group.
Return to step 7 to select a new group.
11. Press Command to exit from adding wireless sensors.

Program Wireless Touchpads

The Handheld and Wireless Wall-Mount Touchpads allow the user to control the system without having to go to the panel. Most operations can be done with a wireless touchpad. The system accepts up to four wireless touchpads.

1. With the panel in program mode, press STATUS + STATUS + (ID number of touchpad, from 1 to 4.)
2. Press BYPASS on the wireless touchpad that you want to add.
3. Repeat steps 1 and 2 for each wireless touchpad.

Install Wireless Sensors And Touchpads

Refer to your planning worksheets for location of sensors and touchpads. Follow manufacturer's instructions for attaching sensor mounting brackets. (See photograph 11.)

The author is Senior Editor at Interactive Technologies, Inc. (ITI), of North St. Paul, MN. For more information contact ITI at (800) 777-5484, fax (612) 779-4879.

The author wishes to thank ITI Technical Support and Technical Publications for assistance with this article.

NATIONAL
AUTO LOCK SERVICE, INC.

National Auto Lock Service, Inc. offers a wide range of equipment and services for the Automotive Locksmith. From tools and hard to find key blanks to transponder programming, we can take the mystery out of car service. We accept credit card orders, and can ship COD. Contact us for the latest in automotive technology.



BEGINNER'S CORNER

To Rekey Or Not To Rekey



by
**Eugene
Gentry**

To rekey or not rekey, that is the question. Sometimes you have to decide whether to rekey locks that are old and worn, or suggest that replacements be installed.

There are two successful locksmith shops I know that operate in two different ways. One replaces locks and the other reconditions locks.

The one locksmith owner has been in business for years and has two full service shops. He does a very good business, but is criticized by his customers and other locksmiths for his high prices. His policy is to replace, not repair locks. He does not rekey a foreign made lockset, or one that is old and worn and his servicemen recommend new

hardware be installed. His yellow page ads are large, and he depends on new business.

The other successful locksmith has been in business over 20 years, and has a full service shop and four service trucks. Using different a business philosophy, he does repair and recondition locks, and rekeys any type of lockset. His prices are competitive and his yellow page ad is tiny. His business is based on repeat customers, some that have been with him for years.

Following are two situations that you might run into where you have to decide to rekey or replace.

A lady, whose keys were stolen, wants all her locks changed. The front

door has a Weiser lock set, and deadlock, the rear door has an import lockset, the front gate has a Kwikset deadlock, and the rear gate has another brand foreign deadlock. The locks are keyed alike and a Kwikset key is used to access all the locks.

A price was given to install new locks to one single brand, but the lady could not afford to do this. She wanted them rekeyed.

When you use a Kwikset key in a Weiser lock, you are not able to use the pin information on either the Kwikset or the Weiser pinning sets. This is because of the cutting specifications are different between the two brands. You can use the pin end of a dial caliper in the plug, with the new key inserted, to determine the correct pin size. This also applies to the foreign locks.

When rekeying the import locks you might run into a spacing irregularity on the plugs. Who ever worked on the locks before at this house left the number five pin out of the import locks so that the key would work properly. In this situation, it would have been better to have all the locks the same brand.

At another house, a man wanted two doors rekeyed, both with a Weiser lockset, and a foreign deadlock.

The Weiser locksets were in bad shape, with loose inside knobs. Each lock had a different key so they had four keys for two doors. A suggestion was made to install new locksets and deadlocks of the same brand, and the man gave the go ahead. The old locks were taken out of the doors, and new ones installed. The customer was happy as the door appearance was improved, and one key opened both doors.

The new locksmith needs to understand when it is feasible to simply rekey existing hardware and when it is necessary to replace it. He/she should carry some moderately priced locks and also some of the more secure and more expensive locks in stock.



**The Innovation You Expect, with
the Flexibility You Need!**

[Click here for more information](#)

G. SELECTOR SWITCH DESCRIPTION			
SYSTEM STATUS	POSITION #1	OFF	ON
AUDIBLE STATUS	POSITION #2	NORMAL	SET-UP
BY-PASS MODE 'A'		NONE	ON DURING BYPASS

BUSINESS BRIEFS



HPC is proud to announce the **9th** winner in their monthly Codemax™ drawing. HPC has awarded a Codemax™ computerized key machine to **Ben Mistilis of Thibodaux Lock & Key in Thibodaux, Louisiana** on **November 1st**. It was purchased through **Herbert L. Flake in Houston, Texas**. HPC will be awarding a Codemax™ to a lucky locksmith every month through February 1996. To qualify, locksmiths simply need to purchase any 1200

Series Key Machine and send in their registration card along with a copy of their distributor invoice to HPC. Once this is done, they will automatically be entered in the contest. Entries will remain eligible until the conclusion of the contest. A total of over \$47,000 will be awarded. There are still **three** more chances to win.

Avanced Hardware Technologies has appointed **Norman A. Millman President and CEO** and **Dwight W. Boyer**, an industry consultant, as **Vice President, Sales and Marketing**. Boyer also serves as General Manager of the Charlotte operation.

Sargent & Greenleaf announces the **Electronic Lock Help Line**. This automated, menu driven program is designed for anyone needing help with the Sargent & Greenleaf models 6120 and 6121 electronic locks.

To use the help line you must have a touch tone phone. To access the Sargent & Greenleaf's Electronic Lock Help Line dial 800-826-7652 extension 500.

Almet, the only completely Canadian owned lock manufacturer in Quebec, will remain open.

Almet International manufactures a line of decorative and architectural lock hardware for both the commercial and residential markets across North America.

Led by their new **President Egidio Aguzzi**, the management team comprised of **Jean-Marc Crete, Vice President Contract Hardware, F. Aubrey Sievert,**

Vice President Retail, Pierrette Genereux, Finances and Antero Resendes, Production, will direct its operation. The company will concentrate its efforts towards customer service and producing quality products.

Greater Chicago Locksmiths Association announces the election of its 1995-1996 Officers and Board of Directors.

The new officers are: **President, Kathy Zaniolo; Vice-President, Steve Gebbia; Secretary, Tom Mazzone; Treasurer, Al Zaniolo; Sgt. at Arms, Larry Hughes.**

Board Members elected for a two year term are: **Roy Miller, Paul Krause, John Greenan, Dave Chmelina, and Gene Smith.**

Board Members remaining for a one year term are: **Destin Bowles, Art Mischewicz, Tony Ruberti, and Don DeFreitas.**



Pictured, standing (left to right), Art Mischewicz, John Greenan, Dave Chmelina, Don DeFreitas, Paul Krause, Gene Smith, Roy Miller, and Tony Ruberti. Pictured, seated (left to right), Larry Hughes, Steve Gebbia, Kathy Zaniolo, Al Zaniolo, and Tom Mazzone. Not pictured is Destin Bowles.

Star Key Industries, Inc. announced its relocation from Brooklyn to New Rochelle in Westchester County, New York. Its new address and phone number are: 10 Pine Court, New Rochelle, New York 10801; 914-235-1700; fax - 914-235-1762. The move is part of the New Star Key's modernization program, which has included an expansion of the product line, the introduction of new plastic headed keys and a dramatic improvement of product quality. **TLN**

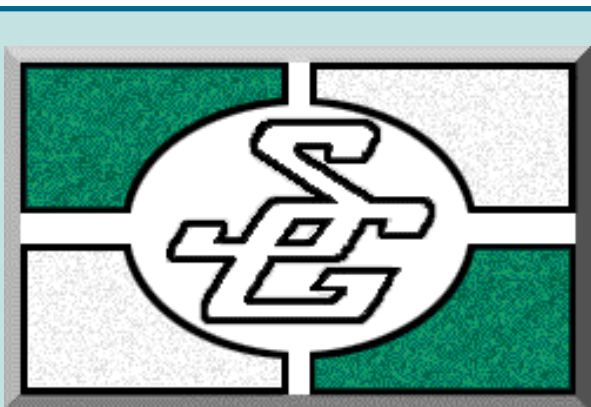

**Make Sargent & Greenleaf's
Comptronic locks your
choice for electronic safe
locking solutions.**

[Click here for more information](#)

The LIGHTER Side

Cause For Alarm



by
Sara
Probasco

"I'm on my way," Don said into the phone one February day. Grabbing his cap and jacket, he tossed the receiver into its cradle and bolted from his office. "Something tripped our alarm at the house," he tossed over his shoulder to me on his way out the front door.

When he arrived at our house, the police and a neighbor who we entrust with a key were already there. The neighbor had unlocked the backyard gate to let the policemen check the rear of the house for signs of illegal entry. One of the alarm sirens in our security system is mounted in the attic of our carport. Going full blast, it was commanding the attention of various neighbors and dogs, some of whom had wandered out into their yards, by now, to see what was going on, others of whom were barking loudly at the commotion.

Don unlocked the door. The patrolmen insisted on entering the

house first. Pistols drawn, they cautiously stepped into the back corridor, with Don and our neighbor creeping along behind. Their eyes and pistols swept the perimeters of each room they came to, alert for an intruder. They searched every room, looked in closets and peeked behind doors and curtains, but no burglar was found.

Finally, after stilling the alarm and beginning to relax, the men congregated in the breakfast area, which is central to the house. Looking about, they were all perplexed as to what might have triggered a false alarm.

Then Don saw it: the red indicator light of a motion sensor came on in the adjacent living room.

In my haste to leave for work that morning, I had neglected to turn off the central heating unit. As the room cooled off, the heater automatically came on. The influx of warm air was

just enough to slowly turn a large mylar Valentine balloon which was tied to the back of one chair at the breakfast table. That slight movement had been enough to set off the motion sensor and trigger the alarm.

With a red face, Don thanked the policemen and our neighbor for responding so promptly to the call. Then he removed the balloon to a room void of motion detectors.

This wasn't the first time we'd had a false alarm with our security system. We had two or three in quick succession, one week, before we finally discovered a small spider had built her nest behind one of the motion detectors. The diminutive arachnid crawling across the face of the sensor was enough to set the siren screaming, when the alarm was set on "go." Once we discovered the problem, we set a routine of weekly spraying insect repellent around our motion sensors, and we've had no repeats of that situation.

In our case, our false-alarms have all had logical explanations. Sometimes it just took a while to figure them out. In the meantime, I found it prudent to keep the police dispatcher and officers on duty supplied with cookies and sweet rolls as a thank-you for their numerous prompt responses.

Once you discover the cause of the difficulty and rectify it, everything works as it should, as a rule. However, sometimes the break-in period (no pun intended) can be a bit nerve-racking.

I understand the same can be said about the installation process. In interviewing various people relative to a recent article on electronics and locksmithing, I listened in amusement to some of the experiences they had encountered.

One told of having finally finished stringing wire through a client's attic. He had frequently cautioned his workers about the perils of working in

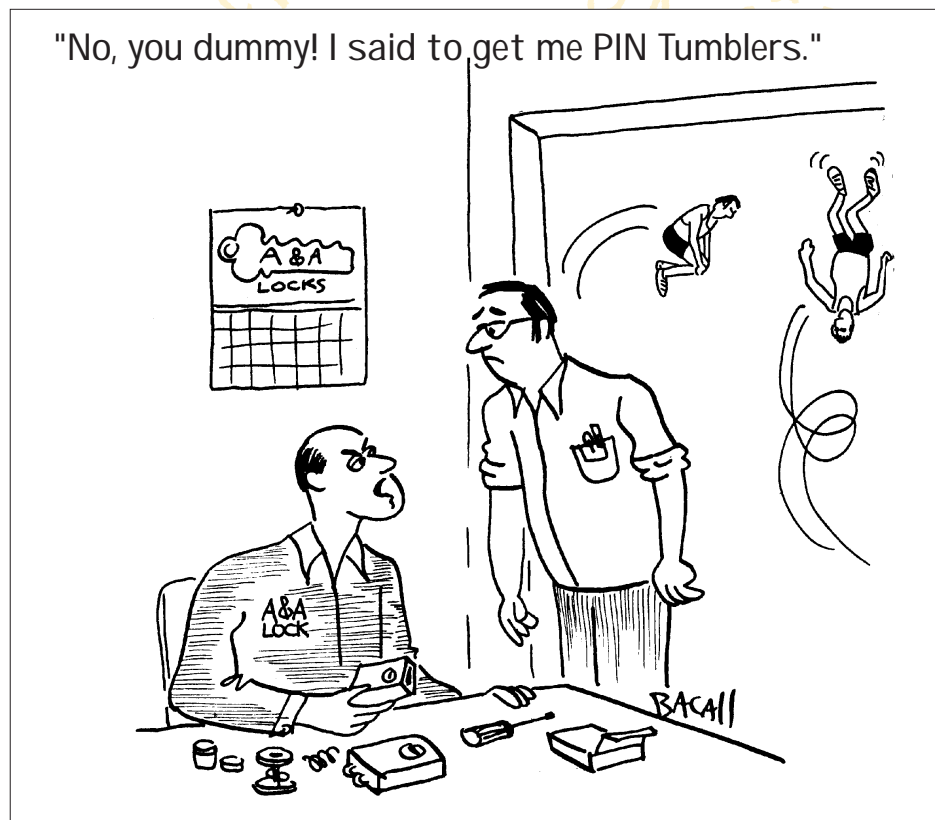

Continued on page 175

DIE DIEBOLD DIE!



**DALE TEACHES US AN IMPORTANT LESSON ON
EDUCATING OURSELVES
BEFORE WE TACKLE THE UNKNOWN.**

by Dale Libby, CMS

The title to the article is pronounced "Die, Deebold, Die." This represents a money chest opening that someone else started and the 'crack' team of Safebusters International finished. The operation was a success, but the patient died.

I will relate the Fable in a chronological order. Most of the information was gleaned from the customer's direct observation, my professional examination and scrutiny, and the brief commentary I had with the locksmith involved.

Along the way, we will talk about billing procedures (mine) and discuss the basics of attacking a Diebold Cashgard TRTL30. The story told will be a condensed version of the "Tale of Woe" and the referring locksmith will not be named. No aspersions will be cast here.

The story starts on a stormy Friday night. A large store (J.C. Nickel) called its locksmith and asked him to take a look at their Diebold Money Chest. It was not opening on combination. The locksmith came and tried to dial the chest open using dialing diagnostics, and number adding and subtracting. He spent approximately three hours on this procedure with no luck at all.

This was the deciding point. He then decided to try drilling to penetrate the unit. Now occurred a

momentous judgment, for he had not really opened any safes in a number of years. He expressed a desire to drill open this unit without any knowledge or information about the safe, lock, handing, or construction of the chest. A recipe for disaster.

His first hole was drilled at 97. He must have thought that the lock was mounted Right hand (RH). It was not. In fact, the lock, as we will soon see is mounted, Vertical Down (VD). After drilling at this point, he should have stopped when he

realized he was in over his head. Instead, he continued drilling and punching the money chest. Defeated, he called me.

Photograph one shows the typical Diebold Cashgard escutcheon plate which is clearly labeled as such. This plate is held to the door by four hidden screws. Photograph two shows the position of one of these screws. They are located 1/2" in from each side of the corners of the plate. They are hidden under a vinyl sticky cover.

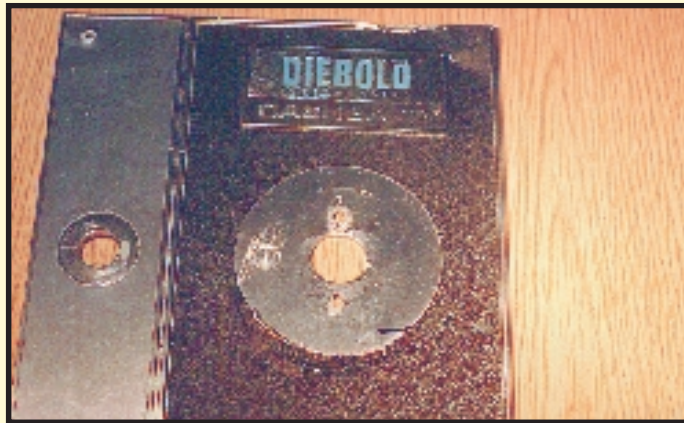

1. Typical Diebold CashGard escutcheon plate with dial mounting holes and hole for opening handle.



2. The hidden corner screws that hold the escutcheon to the door.

The cover can be lifted carefully and the screws removed. Once free, and after the dial ring and dial have been removed by a variety of methods, the escutcheon can be rotated out of the way. The purpose of this is to hide repairs, and it also lets you attach your drilling fixture directly to the door of the chest, and not have to use longer screws and go through the escutcheon plate.

Once the plate has been moved to the side, the drilling can be accomplished at 67 or 68 at 7/8" out. This is at the drop in position. With the right equipment, the opening should take about an hour. In fact, the locksmith in question spent about 10 hours on Saturday, and a few hours on Sunday before he called me.

Photograph three shows the approximate amount of metal, both of the escutcheon and the safe that was removed. This included the spindle tube, all the insulation, all the copper, all the hardplate, and all of the insides of the combination lock.

Billing Problems

When the locksmith called me, I knew that I was in for a hard opening. He did not tell me the extent he had drilled, punched and mutilated the Diebold TRTL30. He stated that he had drilled a hole at 97, and had punched the wheel pack, and that the spindle tube was missing. I had no idea that about four square inches of the safe door was missing all the way back to the remnants of the lock.

My first question is, who is going to pay for this? He first told me I could bill his

customer. But when he found out the approximate cost, he asked me to bill him, and he would pay me when the customer paid him. I stated that I do not do conditional billing, depending on a third party. I would bill either him or the customer.

We decided that I would bill the customer direct. He wanted me to add \$100 on my bill for him. I told him that I would see about this, after looking at the safe. I do not pay referral fees. When I refer a customer to another locksmith, I do not expect a referral fee. If the locksmith in question wanted a fee to recover his hard plate bits, he should have let me bill him, and then he would bill the customer direct including his fee. He stated that he would call Lockmasters for "The Drill Point" thinking that would make everything better. We told him that would not be necessary, and we would take over from here.

The Opening

On large jobs I assemble the Safecracking Team of Safebusters International, which, in fact, is Little

Tommy Powers and Me. We cover Indiana, Wisconsin, and the upper half of Illinois. The location in question was in central Illinois, about 125 miles from Elgin, my home base. Quite a road trip.

Once we arrived at the location, we were both shocked and dismayed at the actual amount of damage and the large size of the holes drilled through the escutcheon. We marveled at the amount of destructive work that was done to this unit. We looked at the unit, looked at each other, and both shook our heads. Because of the amount of damage inflicted to the chest door, we knew that after opening the door, it would not be able to be repaired by our company. The damage was too extensive.

We immediately told the customer this, and gave him the name of a prominent safe and vault company in Chicago that might know how to handle the problem, order a new door, and move the heavy chest if needed. The customer stated that at the present time, they just wanted the door opened as quickly as possible, for the amount of money in the chest was considerable, and that they had already missed two pick ups. They would deal with the repair or replacement of the money chest after we had opened it. We confirmed the price and carted in seven tool boxes and began to work.

Photograph four is an X-ray view of the LaGard lock as it is mounted to the safe door. The pen is pointing to the internal LaGard style relock trigger location. This location was going to be our first hole. Looking into the large cavity,

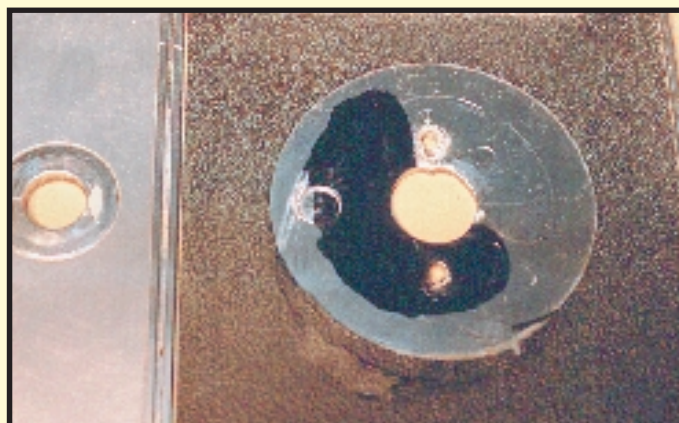

3. The darkened area represents the amount of material, metal, concrete, and lock parts, including spindle tube, that was removed. About four square inches on the surface.

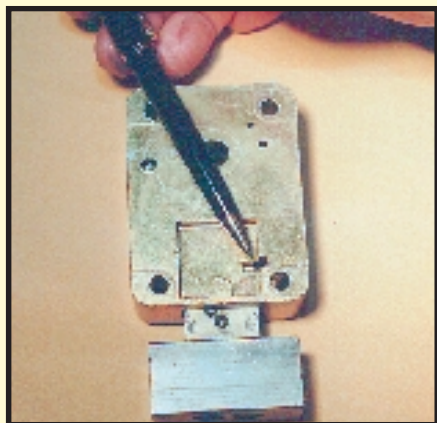

4. The LaGard 3300R combination lock with attached aluminum block. The pen points to the relock trigger.

all we could see was the end of the lock bolt. The lever, the fish plate, the wheel pack, the back cover, and anything else even remotely identifiable was gone, or laying on the inside of the door.

The measurement for this relock "A" spring is 1-3/4" down from dial spindle center, 1/2" to the right. This is a simple measurement, when you have a spindle hole, or even two dial mounting screw holes to measure from. Because of the damage to the door and escutcheon, this measurement took about 10 minutes to determine. We made four different geometric constructions and finally agreed on the proper place to drill our first hole.

After drilling through two hardplate layers, and two copper layers, we drilled off the internal relocker with a 1/4" drill bit. The positioning of the copper next to the hardplate was a stroke of genius by Diebold. One does not actually drill diabolical Diebold hardplate, one burns through. With the location of the copper layer, the hardplate was harder to drill through (Burn through) because the copper was dissipating the heat to the hardplate.

Once the relocker was drilled, we tried to raise the bolt with the attached aluminum block. Photograph five shows the inside view of the lock and block. (This is not the lock that was on the chest, but one from my extensive archives). This was impossible. We had to make another hole.

I have become an expert at dual-duty drilling. What I mean by this, is that I try to have the drill bit work for



5. Front of the lock with attached ALCOA aluminum blocker block attached. The block measures 1"x1"x2".

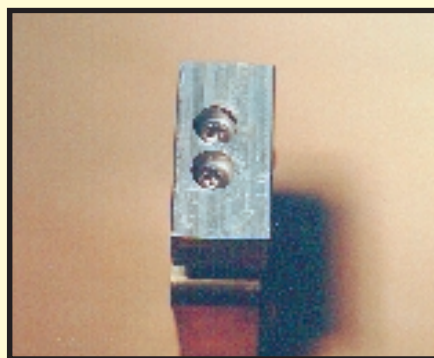

6. The block is attached to the bolt with two recessed screws and lock washers.

me as well as drilling a hole. If I know that the relocker is to the right of the lock and mounted VD, I will drill to the right of the relocker and have the momentum and movement of the drill not only get me to the relocker, but also to 'grab' the edge of the bolt and raise it in the proper direction. I have had very good luck with this procedure, as can be seen in past articles.

This was also true in attacking the Diebold CashGard. Photograph six shows an edge view of the blocker

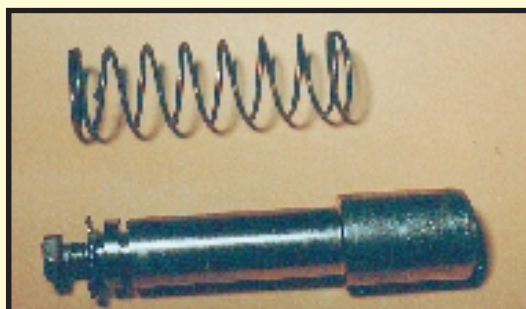

7. The bolt/relocker with high tension spring. Note the slot at the rear of the bolt, next to the mounting bolt. This is the slot for the back cover to attach and move the bolt.

bolt. It measures 1"x1"x2". It is attached to the end of the lock by two #10-32 screws and lock washers. When servicing one of the units for a customer, these should be checked for proper tightness.

We decided that one 1/4" more hole would be drilled at the very bottom edge of the aluminum block. If the hole was perfect, then the drill would pop through exactly at the bottom of the bolt, and when twisting to the right would burst through and by virtue of the clockwise revolution of the bit, raise the blocker block enough to let the unit open.

Again, we measured exactly 3-3/4" down from our centerline, drilled and penetrated the copper layers and the hardplate. The drill bit finally poked through the last layer and became wedged in the hole. Wonder of wonders, the handle moved enough to let us open the door. The block had been pried up enough to let us get the unit open.

Photograph seven shows one of the active bolts/relockers that this chest covers. This unit has an unusual feature that the opening handle moves a large plate on the back of the door which pulls back these spring loaded bolts. If the back of the lock is punched, and this plate is dislodged, the bolts will spring into the fully locked position and become disconnected from the plate.

To release these 4" by 1" diameter bolts once they have been set, drilling from the side is necessary. On this unit, the back plate almost released these bolts. They were still connected enough to open the safe one more time.

Conclusion

A week after the opening, the locksmith called and asked if we had added \$100 on to the bill for him. We stated that "no," we did not add on any money for punching and destroying a customer's safe. If he had been straight from the start with me, I would have told him this.

If you are going to try and tackle safecracking, do it on a regular basis, get massive amounts of education, purchase the "Safe Opening" books by Dave McOmie, and do not go into it blind and stupid. It is a very important and consequential decision to go into safecracking. Do not take it lightly. Open and Prosper!

TECHNITIPS

Helpful hints from fellow locksmiths

Send in your
tips and win.

HOW TO ENTER

Simply send in your tip about how to do any aspect of locksmithing. Certainly, you have a favorite way of doing things that you'd like to share with other locksmiths. Write your tip down and send it to: *Jake Jakubowski, Technitips Editor, The National Locksmith, 1533 Burgundy Parkway, Streamwood, IL 60107* or send your tips via E-mail to the E-mail address posted in the upper right hand corner of this page. Remember, tips submitted to other industry publications will not be eligible. So get busy and send in your tips today. You may win cash or merchandise. At the end of the year, we choose winners for many major prizes. Wouldn't you like to be a prizewinner in 1995? Enter today! It's easier than you think.



by
Jake Jakubowski

BEST TIP OF THE MONTH

If your tip is chosen as the best tip of the month, not only do you win the All-Lock Foreign Auto Service Kits, but you also automatically qualify to win one of the many excellent year end prizes!

EVERY TIP PUBLISHED WINS

Yes, every tip published wins a prize. If your tip is printed, you'll win \$25 in Locksmith Bucks. You can use these bucks to purchase any books or merchandise from *The National Locksmith*. Plus, every tip published will win a copy of the Technitip Handbook. (Please remember to include your complete mailing address - we cannot mail prizes to P.O. Boxes.)

America Online: NATL LOCK

Use the above address if you are on AOL.

Internet: natllock@aol.com

Use the Internet address if you are not on AOL.

These Prizes Awarded Each Month!

- All-Lock Foreign Auto Service Kits - Worth Over \$225!
- Strattec Pinning Kit and Jacket
- American Lock & Supply \$50 Merchandise Certificate
- HPC Pistolpick
- Sargent & Greenleaf 4400 series safe deposit lock
- Silca Rubberhead Keyblanks (100 Blanks)
- Pro-Lok PK15 Professional Lock Pick Set
- Sieveking Products EZ-Pull GM Wheel Puller
- A-1 Security Mfg. Quickpull
- Major Mfg. CAK Cylinder Access Kit

This is it! Here's the last Technitip column of the year! Y'all know what that means don'cha? It means that next month-January, 1996-I'm going to announce the year-end prize winners for 1995!

Do y'all know what the GRAND PRIZE is goin' to be? I'm goin' to give some lucky tipster a Silca Matrix Key Machine! An' that lucky locksmith will have won that machine because they thought they had an idea worth sharin' with the rest a' y'all!

Anyway, next month, I'm gonna tell y'all who the winners of all the great prizes were. Y'all been seein' the list all year so I'm not gonna repeat it here.

How-some-ever, there is somethin' that I want to repeat to y'all. It concerns your mailin' addresses. When you send me a tip, I need to have your physical address, not a P. O. Box number. And for those of you that are sendin' your tips in by E-mail, a lot of you are not sending me any address at all!

That's a shame, 'cause I've gotten some good tips from some of y'all on "the net" but I can't use them since I don't have a physical address.

But, as the ol' radio preacher used to say: "Keep them cards and letters comin' folks!" Just remember to include your name, physical address and your telephone number ... if you don't mind. The reason I ask for your telephone number is ever' onct-in-a-while, there may be somethin' that ain't quite clear to me in your tip an' I'll give you a call to clarify the point.

Anyway, let's git on with this month's column and y'all be sure to be here next month and see iff in yore name 'pears on my year-end winners list!

Oh! One more thing. Me an' Christie (She's the lady that keeps that grin on my face!) want to wish each and everyone of y'all out there the very, very best of the holiday season an' even if you don't win one of the year-end prizes we hope you have a very prosperous New Year! Y'all heah me, now?

All-Lock Foreign Auto Service Kit Winner **Lexus Ignition Pick**

Enclosed are illustrations and diagrams of picks and turning tools that I made and used to pick the ignition lock of a 1992 Lexus 300!

Once I had picked the lock, I was able to have a key made from the numbers stamped on the wafers. I had previously gained some experience picking this type of lock by working on the Bell style parking meter locks and

decided that I wanted to experiment picking this high security automotive lock.

With my experience picking Bell locks and information that I had gotten from the Auto Security Article in the January, 1993 issue of *The National Locksmith*, I obtained a Lexus ignition lock and housing from a salvage yard. I removed the housing from the steering column by grinding a slot in the two large shear head bolts. After uncoupling the main wiring harness, I had the lock housing in hand. (See illustration 1.)

Since I didn't have access to computer generated patterns to simulate the contours of the Lexus codes, I used the key and bitting information from the above article to guide my efforts to make six rake-style picks from .10 x .025" flat spring stock. I made two single "bump" rakes and four multi-bump rakes with varying degrees of bend and depth. If you want to try this, make sure to place a half loop in the tail-end of the tool to facilitate using the pick. And, make sure to bevel and polish the working tip so that it will slide under the wafers without hanging up or binding. (See illustration 2.)

The tension wrench that I made is connected to the back of the lock by fitting over the lug that drives the electrical switch. To make this tool, use a short piece of 5/8" diameter wooden dowel. In the exact center of one end, drill two 1/8" holes side by side. Near the other end of the dowel, in line of the lug, drill a 1/16" hole in the side of the tool. Place a piece of round spring stock in this hole and bend a "V" in it.

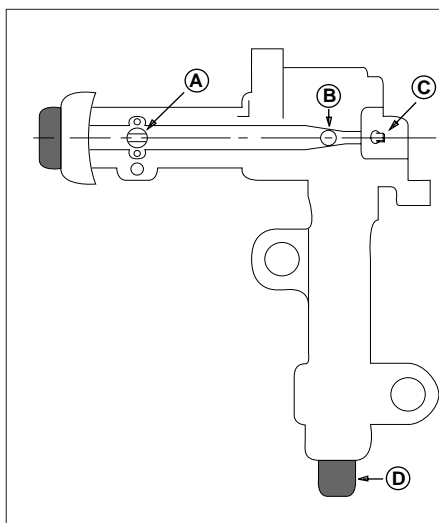

Illustration 1

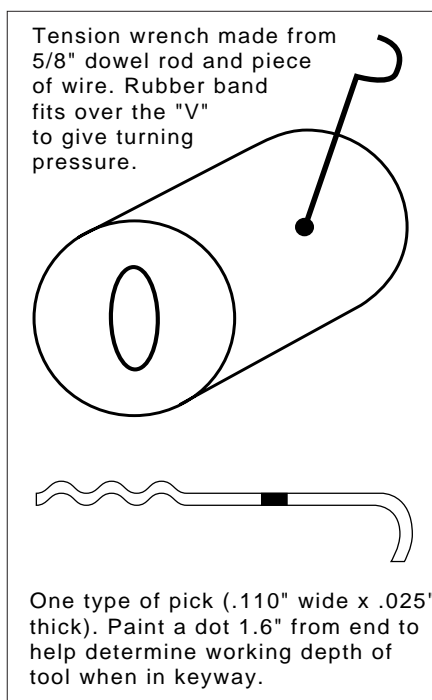

Illustration 2

There are two steps necessary to remove resistance to picking this lock. The first is the beveled metal guide in the keyway which must be pushed down and held out of the way. To do this, drill a small hole at point "B" in illustration one and use the homemade thumb tack shown in illustration two to push the bar down. Hold the tack in that position with a rubber band.

The second step is to hold the steering wheel locking bolt in. (See location D in illustration 1.) You can accomplish this by placing a small block of wood over the lock and keep it in place with another rubber band.

Next clamp the housing in a vise and clear the keyway. Block the

- A.) Buzzer Button Hole**
Push metal key guide down into the keyway. Trap bar at point "A", or:
- B.) Centerline of lock housing.**
Drill a small hole at point "B". Use a tack to hold button down and tape it in place.
- C.) Actuator lug (concealed).**
Protrudes from the back of the lug housing. It connects the mechanical lock to the switch.
- D.) Steering Wheel Lock.**
Place a block over this and use a rubber band to keep it in place.

steering wheel lock "in" and apply turning tension to the back of the lock. You may want to vary the tension on the rubber bands as you progress. Slide one pick under the wafers at the bottom of the keyway. This pick is lifting six wafers. Four of those wafers are split wafers and two are regular wafers.

Simultaneously, insert the second pick into the lock at the top of the keyway. This pick pushes down on four wafers. Two of them are split and two are regular. Work both picks in and out together. Try alternating pushing one and pulling the other. Or rake one side while holding the other pick steady. While pulling one or the other of the picks almost all the way out of the lock, rock it left and right. This helps pick the split wafers of different depths in the first three spaces. Remember to alternate the action on the upper and lower picks.

I, more than anyone, realize that I was working on this lock under controlled conditions and the success I enjoyed could not -at this point at least-be duplicated in the field with the lock on the car. However, I'm convinced that my early success in picking this lock can lead to a viable means of picking some of these high-security locks.

Leo Koulogianes
Tennessee

Editor's Note: Leo's tip shows a lot of resourcefulness and ingenuity. It is experimentation like this that leads to newer and better tools for our entire industry. Locksmiths like Leo wonder why something can't be done and rather than accept the conventional wisdom that says, "That'll never work!" — they try to find a way to make it happen. As Leo pointed out in his tip, he picked this lock under controlled conditions and with the lock out of the automobile. However, that does not take away from the fact that he found a way to do something in a different and creative way.

At this point in time, however, it would appear that the quickest way to generate a key for this car from scratch would be to start with the trunk lock, decode it and progression the last two or three (depending on the model your working with) cuts for the ignition. See The National Locksmith's AutoSmart reference manual by Michael Hyde for more information.

Continued on page 168

Continued from page 166

In the meantime, it will be locksmiths like you and Leo that will likely help develop the tools we'll need to make our jobs easier in the future.

Strattec Pinning Kit And Jacket Winner
Chrysler Lock Diagnostics

A customer called complaining that he could not get his ignition key to enter the keyway of his 1989 Dodge Caravan without difficulty. He said he had used graphite in the keyway and then tried WD-40 with little luck. He wanted to know how much I would charge to install a new ignition.

Before quoting a price, I asked him about the "history" of the switch and if he had any keys that seemed to work better than the one he was having trouble with. He told me that the problem had been progressive and the key he had been given when he bought the van seemed to work best.

When he got to my shop, I tried the keys he brought with him and found it was very difficult to get any of the keys in or out of the ignition switch easily. Thinking that there might be something wrong with the "duplicates" (none were original keys), I checked the keys, paying particular attention to the "ramps" at the tip. There did not seem to be any problems with them.

Next, I code cut a key on my 1200. Same problem. I even tried filing the tip of the key to a shallower angle. That didn't help either. I felt, then, that there was nothing to do but replace the switch.

After tearing down the column and removing the switch (You're right, Jake! Murphy and Mother Nature are out to get us.) I found I did not have the proper replacement switch! I had the older All-Lock #1444 (which I had somehow placed in the wrong box) and needed an All-Lock #1449 - which I didn't have.

Just about the time I was ready to hit the panic button, I remembered something I had read several years ago about unusual pin wear in Chrysler product ignitions that would prevent the key from entering the ignition or render the key useless. Since I already had the ignition out of the column, I decided to remove the retainer and check for pin wear.

I dumped the first chamber (the number one pin) and held the rest of the springs down with my finger and

inserted the key. It went in as slick as a whistle! I repinned the first chamber with the appropriate pin, driver and spring and tried the key again. No problem! Replacing the first pin allowed the key to work smoothly.

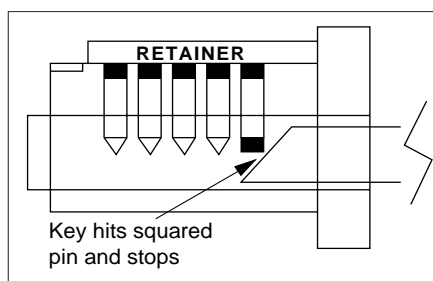

Illustration 3

Illustration three shows how the pin had worn. Notice that the chamfered area of the pin had become almost squared. Each time the key "hit" this obstacle, it distorted the pin just a little more until it would no longer work properly.

Apparently, the amount of "play" in these ignitions is the root cause of this problem. If you hold one of the older, single-sided ignitions in your hand and try to insert the key too high or too low, you can feel it "bottom out" against the first pin. I believe that's what causes the wear on this switch.

Sharon Shackelford,
E-Mail

Editor's Note: The problem described by Sharon is a commonly found problem in Chrysler ignitions. From my own experience, and from talking with others, the unusual wear that Sharon found is most common when the first chamber contains either a number one, two or three pin. The diameter of the chamber is such that it will

allow these shorter pins to "slip" or "cock" to the side and bind. When this occurs repeatedly, the pin will wear as seen in Sharon's illustration. Once that process begins, chronic binding or an inability to insert the key will occur. I believe the best solution is to install a new ignition and code it to the customer's existing key. Of course, when you experience a "Murphy" kind of day like Sharon did, you work with "what ya' got". Although this info may be "old hat" to a lot of locksmiths, there are a lot of new folks out there that have not encountered this problem yet.

American Lock & Supply Winner
Master Lock Master Key

Here's a way to determine the mas-

ter key for a series of #3 Master padlocks that have been master keyed when you only have one lock and one change key to that series. First, duplicate the customer's change key and set their key to the side. That way you will not inadvertently destroy the customer's key.

If the customer's key has a code number, that number should be used to generate the key(s) that you'll need to work with. If there is no code number available, decode your duplicate key and rotate the bitting. In this case we will assume it's 3-4-3-5.

Either with a code machine or with space and depth keys, cut your first key to 0-4-3-5. Try the key and see if it will turn the plug. If not, cut the number one space one depth deeper and try the key. Repeat this process on the first space until the key turns the plug. You know it will turn when you cut the first space to a three depth, but that does not necessarily indicate you have the master bitting in that position. You have to try a four and a five. If only a three depth, in the first position, turned the plug then a three depth would be the master bitting in the first space. Just for fun, let's make the master bitting a one depth.

Now cut a second key to the following code: 1-0-3-5. Repeat the same process in the second space to determine the master bitting for that space. Let's assume you find the master bitting to be a five. Cut your third key to 1-5-0-5. Repeat the process in the third space. Here we'll call the master bitting a one cut. You cut your fourth and final key to 1-5-1-0. Repeat the process for the fourth space. Let's say the master bitting turns out to be a five (which is the same as the change key). That should give you a master key with the following bitting: 1-5-1-5. That bitting should give you the master key common to that particular series of master keyed, #3 Master padlocks.

Just remember that you have to progression each space separately, one depth at a time. And, just to make sure you have the proper bitting, you have to exceed the change key depth whenever necessary to determine the proper master bitting for that chamber or spacing.

R. W. Staples, CML.
Washington

Continued on page 177

Continued from page 168

HPC Pistol Pick Winner

Impression GM Glove Box

Removing the plug from the paddle handle style glove box on GM cars such as the Olds Cutlass, Ciera, Achieva and Cadillac Deville, etc., to get the last four cuts can be a real challenge if you don't have three hands. These locks can be impressed and since there is enough "slop" in the lock, your key does not have to be 100 percent accurate.

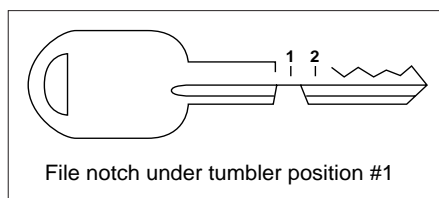

Illustration 4

Once you have a key that will turn the plug (even if it's tight), remove it, turn it over and file a notch on the bottom of the blade in line with the position of the number one wafer. (See illustration 4.) Don't file any deeper than the top of the groove. It isn't necessary and the key could break if the plug turns "rough."

Next, reinsert the key in the lock, turn the plug to the "stop," depress the retainer through the hole and turn the plug to the removal position. Now you can insert another blank, determine your depths and accurately cut a working key to continue progressing the key.

Barry Christy
Pennsylvania

S&G 4440 Safe Deposit Box Lock

IC Key Control

I do a lot of I-Core service work and have found two common problems that lead to complaints about "those keys you made me don't work."

The first problem occurs when the bottom milling on an interchangeable core key gets bent or distorted. The customer cannot get the key to enter the keyway when that happens and will quickly call you to tell you your key doesn't work.

The solution is simple. Just take a small file and file the milling back to its original dimension. Sometimes, you have to first take a small-bladed pocket knife or similar object and open the milling a little before filing.

The basic cause of the problem stems from customers using their keys to beat, poke and pry on things like paint can lids and paper staples. However, it can occur when the key is carried on a large ring and is constantly being hit against other keys, etc. So, before cutting the customer a new key, check the bottom milling first.

The next problem occurs when the locks are in a dusty, oily or highly contaminated environment. Dust and other air-borne debris tend to enter the keyway. When the key is inserted, these contaminants are pushed to the back of the keyway and begin to build up against the key stop. With the tolerances being as tight as they are in an interchangeable core plug, it does not take long before the debris in the keyway will prevent the key from operating the plug.

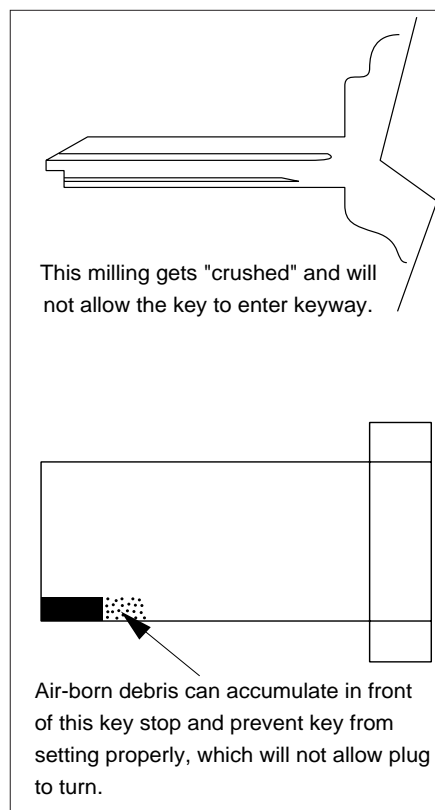

Illustration 5

If you cannot clear the stop with the core in the cylinder, you will have to remove the core to correct the problem. To do this, cut a control key and file back (just a little) on the leading edge of the key stop. (See illustration 5.) If you don't file enough the first time to allow the control key to work, continue filing a little at a time, until the plug turns to the control shear line.

Once you have the core in your hand, you can perform whatever service is necessary to correct the problem(s).

Tom Gallian, CPL
North Carolina

Silca Rubber Headed Key Blanks Winner
Cash Box Cam Lock

A recent service request was to install new cam locks on several cash drawers in a local business. Over the years, the original cams had been broken or distorted, the keys lost and in some cases the locks were missing altogether. As usual, it was a "hurry up, we've got to have this done right away" type job.

When I got to the job site, I found I did not have the type of cam lock that was original to the registers. I told the manager that I could order the locks but it would take a couple of days for them to arrive. He said he needed the work done "Now!"

The only cam locks I had on my truck on my truck were some National C-8060, 1-3/4" Cam Locks which on first thought, would not work because they were too long for this particular application. Besides, the customer wanted a key-retaining lock on each drawer. The C-8060 will allow the key to be removed in the locked or unlocked position which can be any one of four positions depending on how you place the stop washers.

The first problem was to make the longer National cam locks work in place of the original locks that were on the drawers. Illustration six shows the spacer that I epoxied to the lip of the drawer opening to act as a pull-stop when the cam was turned to the locked position. That was the easy part!

Figuring out how to make these locks key-retaining took a little more thought. Illustration six also shows how I solved that problem by filling in three of the wafer broachings in the lock cylinder with a quick setting epoxy. This epoxy comes in a single stick that has both the "A" and "B" parts together. You can find it at most automotive parts stores, plumbing supply houses and some hardware stores.

At any rate, I filled the three broachings I would not use with epoxy as shown in the illustration. While the

Continued on page 180

Continued from page 177

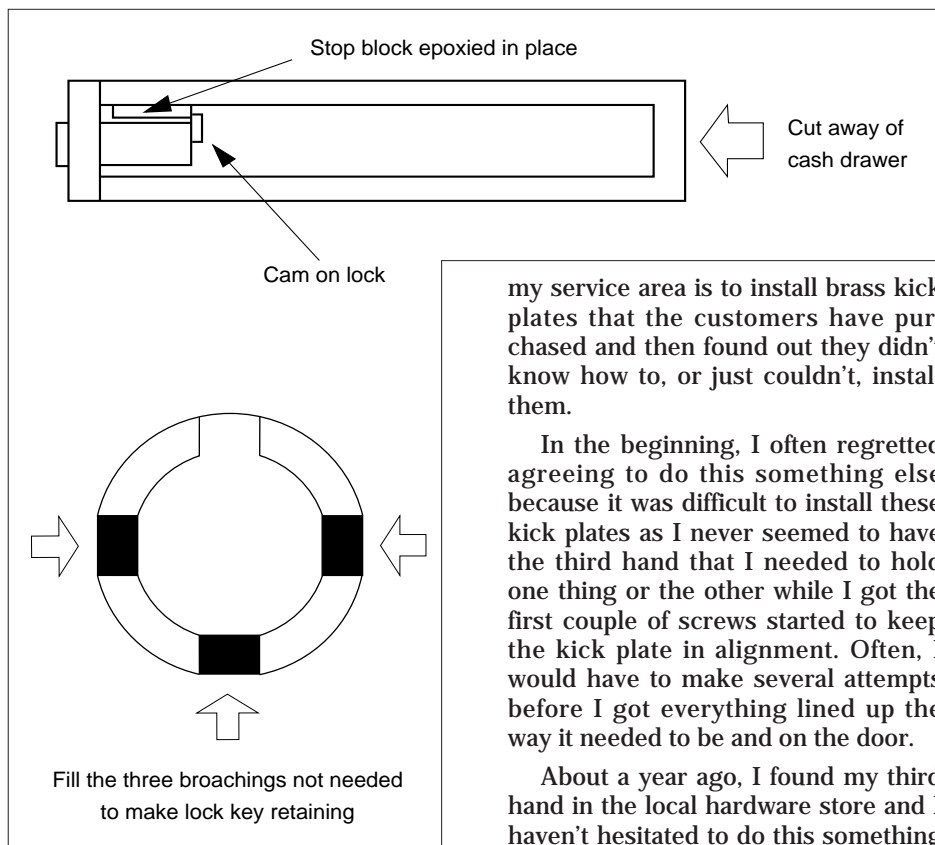

Illustration 6

epoxy was still workable, I used the butt or shank of a drill bit to smooth the epoxy and press it into the broaching. You don't have to get it even with the inside diameter of the cylinder, just make sure there is enough epoxy in each broaching to prevent the wafers from moving upward into the broaching and allow the key to be withdrawn. And, of course, make sure the epoxy is completely set before you insert the plug in the cylinder.

After the epoxy had set, I tried the plug to make sure it would turn freely in the cylinder. If one bound in any way, I used a small round file to adjust my tolerances. Next, I checked to make sure that the key could only be removed in the locked position.

Problem solved. And, yes, I did charge the customer accordingly.

Pete Gamble
North Carolina

Pro-Lok PK-15 Professional Pick Set
Winner

The Third Hand

Like other locksmiths, I'm occasionally asked to do something else while I'm on a job. A frequent request at the many new homes being built in

my service area is to install brass kick plates that the customers have purchased and then found out they didn't know how to, or just couldn't, install them.

In the beginning, I often regretted agreeing to do this something else because it was difficult to install these kick plates as I never seemed to have the third hand that I needed to hold one thing or the other while I got the first couple of screws started to keep the kick plate in alignment. Often, I would have to make several attempts before I got everything lined up the way it needed to be and on the door.

About a year ago, I found my third hand in the local hardware store and I haven't hesitated to do this something else for any customer that asks me to. In fact, if I see a kick plate in the garage, or on the front porch of a customer's home that needs installing ... I let them know, that for a small fee, I would be happy to install it while I'm installing their deadbolt or whatever. It's a quick, clean way to pick up a few extra dollars.

I have also used my third hand to hold push-pull plates and other hardware that is difficult to control, in place while I'm getting my first couple of screws started. What is it? Why, it's nothing more than double-faced carpet tape! I buy a couple of rolls of 2" wide double-faced carpet tape every few months or so.

Then, when I need a third hand to hold a kick-plate, push-plate, etc., I just run a strip or two of the tape down the back of the item, stick it in place on the door and it stays there until I get all of my screws inserted. Try it! I think it's great stuff!

Charles F. Manchester,
E-Mail

Sieeking EZ-Pull GM Wheel Puller
Winner

Trunk Popper

Here's how to make two "Trunk Poppers" for only \$14 plus sales tax.

Stop by your local Radio Shack store and purchase one package of coiled Cord Test Lead (Stock # 278-750B) for \$5.95, one package of Wire Piercing Probe Adapters (Stock #278-715A) for \$3.29 and two Heavy Duty Lighter Plugs (Stock #274-335A) for \$2.39 each. Although the Wire Piercing Probes are not necessary, they make getting a connection much easier.

Attach one of the test leads to the positive connection (the tip) of the plug), then attach the probe to the lead. Now all you have to do is plug into the car's cigarette lighter and touch one of the wires behind the trunk release button. If the trunk does not pop open immediately, then push the button to complete the circuit.

Lenny Wagner
Illinois

A-1 Security Mfg. Quick Pull Winner
Under-The-Window Remedy

Illustration seven shows how to make a guide for Under-The-Window opening tools that, with a heavy-duty

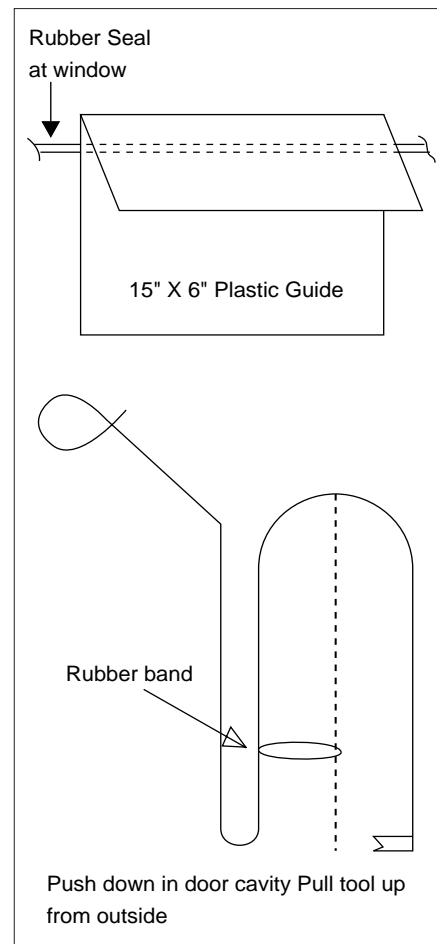

Illustration 7

Continued on page 182

Continued from page 180

rubber band, will prevent the tool from hanging up on any object on the inner door frame of the car.

This guide is made of a thin 1/32" piece of plastic about 15" long and 6" wide. Simply bend the plastic about 3" down from the top edge like you see in the illustration and insert it between the window and the weather stripping as shown. Then slide your tool down along side of the guide and up through the inside of the door.

As you pull/push the tool down over the inner door edge, the rubber band will stretch, allowing the tool to expand. Yet, the rubber band will help pull the tool in towards the buttons. If the buttons are deep on the door, the rubber band will release over the top of the tool as you continue to lower it into the car. It really works!

T. Hoffman
Michigan

Major Manufacturing Winner

Easy Thumb Turn

Here's an easy way to make a thumb turn key for a customer from

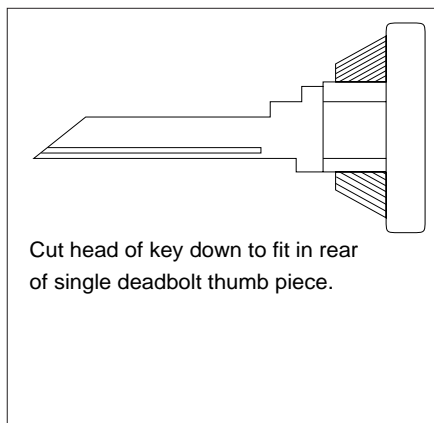

Cut head of key down to fit in rear of single deadbolt thumb piece.

Illustration 8

an old Kwikset or Schlage single cylinder thumb piece.

First duplicate the customer's key onto a blank and then cut or file the blank down as shown in illustration eight. Insert the specially prepared key in the slot in the thumb piece as shown and use an all purpose epoxy paste to hold it in place. Once the epoxy has hardened, simply insert the "thumb turn" in the inside cylinder of the double cylinder deadbolt.

This "trick" will work regardless of the type of key (Y-1, KW-1, SC-1, etc.) or make of deadbolt. It also makes an

excellent large bow key for folks that have arthritis or are disabled.

Robert Purdy,
California

Grab Bag Winners

Easy Card Dispenser

Here's a little trick that I use to help get my name out to the public. All it takes to make this advertising tool is some business cards and a couple of cassette tape cases, some vinyl stick-on letters and a piece of double-faced tape.

I attach these dispensers to the rear window of my service vehicle. Whenever I am in a shopping center or curbside doing work for a customer, I flip the top of the cassette case down so folks can take one of my cards. With the stick-on letters saying: "Take One" over the holder, people do.

When I'm finished working and am ready to hit the road, I just close the dispenser and I'm on my way. Several customers have told me they called me because they saw my card display at a shopping mall or grocery store

Louisiana

Hidden Key Codes

I have often had customers bring me broken keys for Nissan and Toyota autos who only had the head portion of the key. If it is an original key, the code is often stamped on the upper part of the blade which makes generating a key simple.

I have come across situations where there was no visible code on the blade of the key. When that happens and I am sure the key is original, I peel the rubber back from the blade. Often the code is under the rubber head.

Larry Bennett
California

AC/DC Motor

A blower motor from an under-the-dash air conditioner from a junked auto-mobile makes an excellent DC motor for a Foley Belsaw 200 machine. I got one for my machine for just two bucks! Of course, I had to take it out, but it was worth it.

I hooked it up in tandem with the regular motor on my Foley machine. Now I can use the AC motor if I'm close to an outlet, or the DC motor if I'm not.

James Mortimer
Iowa



Free freight!!

No middle man!!

Click here for more information

THRU THE KEYHOLE

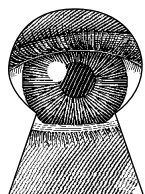

A Peek at Movers & Shakers in the Industry

ATTENTION MANUFACTURERS AND DISTRIBUTORS: Would you like your company and products to be profiled in *Thru The Keyhole*? Please call Managing Editor, Tom Seroogy at (708) 837-2044.

Midwest Wholesale Hardware

When Ed Nettles incorporated Midwest Wholesale Hardware in 1987, there were seven employees and they occupied approximately 8000 square feet of office and warehouse space. Today, Midwest Wholesale Hardware has its headquarters in Kansas City, Missouri and also a full service sales and warehouse operation in Orlando, Florida. Midwest currently has 55 employees and occupies 57,000 square feet of space to warehouse approximately 3500 inventory items representing 22 manufacturers.

Mr. Nettles is extremely proud of all personnel at Midwest and credits them as the single biggest reason for the success of the company. Midwest employees five full time outside salesmen who travel the United States calling on customers. They employ 12 inside sales people who are actually consultants and technical advisors to the customer. These sales people, as well as the customer service and warehouse personnel, are continually being trained and reeducated to keep pace with the ever-changing marketplace, new products and modification of products.

Midwest Wholesale Hardware has chosen to represent primarily American made products produced by quality manufacturers. It is also a philosophy of the company not to sell to end-users. Midwest feels that by not selling to contractors and institutions; they are not competing with their customer base.

Midwest continues to upgrade their communications equipment to maintain superior service to the

customer. In addition to having an on-line integrated computer system, Midwest has recently acquired an imaging system that stores all information such as invoices, shipping tickets and purchase orders on compact discs. This process greatly reduces the time required to retrieve information requested by the customer. Midwest continues to look for new products and services that will enhance its value to the customer.

Bob England manages the operation at Midwest's headquarters in Kansas City and Jim Lee is the manager at the Orlando location. Both individuals have been with the company since its inception and are customer oriented managers.

To contact Midwest Wholesale Hardware call (800) 821-8527 in Kansas City or (800) 659-8527 in Orlando.

HEWI-for Complete Door Hardware

In a concerted effort to increase service to locksmiths as well as to distributors and installers, HEWI, Inc. has recently added a series of mortise locks to their already extensive line of door hardware.



The mortise locks, available for all functions, are sold in complete sets with lever handles in three designs and 13 colors. The sets include standard cylinders when required, or may be ordered with Schlage C keyway. They may also be ordered without the cylinder. The lever handles, made of high quality nylon with steel or aluminum/steel cores, are also sold with HEWI's passage and privacy latches, making it possible now to specify HEWI lever handles with the appropriate hardware for all entrances in a building and purchase it all through a single supplier.

HEWI nylon, made by BASF, is always comfortable to handle. It insulates against changes in temperature and static electrical discharges. The smooth, non-porous surface resists bacteria and is easily cleaned with a damp cloth. These beneficial features of nylon combined with its durability make HEWI lever handles a practical and attractive choice for any application.

In addition, HEWI's line includes products to color coordinate throughout the building, such as pull handles, push and kick plates, bathroom accessories, railing systems, cabinet handles and grab bars.

HEWI, Inc. continues to meet the challenge of providing a growing market with nylon door hardware products by adapting existing products and developing new ones to improve ease of installation and longtime durability on the job. Focusing on the expansion to market areas in Canada, Mexico and South America are also included in product development.

For more information about HEWI Mortise Locks and door hardware, please contact HEWI, Inc., 2851 Old Tree Drive, Lancaster, PA 17603 (717) 293-1313.



TEST DRIVE



**Taking Industry
Products for a Spin
Around the Block**

THE DREMEL MULTIPRO™ CORDLESS 7700

PRODUCT: The Dremel tool kit MultiPro™ Cordless 7700. Available through Dremel distributors, the suggested retail price is \$82. As price varies among the distributors, pricing below \$82 is easily found. For information contact Dremel at (800) 437-3635.

PRODUCT DESCRIPTION: The 7700 is a battery operated tool offering a 7.2 volt rechargeable battery, changeable collet (1/8" comes standard), two speed settings (7500 and 15000 RPM), battery charger, 25 accessory bits (including cutoff wheels), and a strong plastic storage case. Replacement batteries are available directly from Dremel and cost approximately \$22.

FRIENDLINESS: Whether using a standard palm grip or pencil grip, the 7700 is extremely light and is quite well balanced, making even intricate work easy.

The collet is hand tightened and does not require a wrench or other

tool for changing bits. To accommodate the various bit shank diameters, four different collet sizes are available - 1/32", 1/16", 3/32" and 1/8" (standard) - and are also changed without the use of extra tools.

For carrying and storage, a large plastic case is included that offers protection to the 7700 and all its accessories. Small compartments in the case keep the components well separated and organized.



To remove the battery, simply depress the two locking tabs that hold it into the tool and remove. For charging, place the depleted battery into the charger and plug it directly into the wall. Because the charger is so light and compact, it is designed without a cord. The charger with battery is plugged directly into a wall outlet. Recharging takes approximately 3 hours.

It should be noted that the shape of the battery pack allows the user to stand the 7700 up on end when not in use, conserving space and making it much handier.

A large slide switch is well integrated into the unit's body for selecting either the 7,500 or 15,000 speed. The motor on this unit is strong and reliable.

COMMENTS AND SUGGESTIONS:

Like previously tried Dremel tools, the 7700 ran long and strong even on steel door and frame work. Still, because it fit and balanced so well in the hand, even intricate work was completed quickly and accurately. Switching between speeds was fast and easy, and changing bits was a snap. If any improvements can be made, as I'm sure there will be, a quick charge battery should be first on the list.

CONCLUSION: Put your other tools down, locksmiths. Dremel's 7700 Cordless MultiPro™ tool is one of the best little power tools we've found. Because it's battery operated, it can be used anywhere. Being lightweight and easy to handle makes it perfect for deburring or reshaping miscellaneous lock parts. Dual speeds lets you work with a variety of materials including plastic and steel or aluminum frames and doors. **TL**

FEATURES: The 7700 cordless is a whole new tool design offering many features and refinements that allow it to sit head and shoulders over the older and reliable Dremel cordless units.

Most noticeable is that the battery is removable. Unlike older versions where the battery is an integral part of the tool, the 7700 has a plug in battery pack. This redesign allows the unit to be used at all times by simply plugging in a good battery while the depleted battery is charging.

DESCRIPTION:
Dremel's MultiPro™
Cordless 7700.

COMMENTS:
Lightweight and
tough. The battery
pack concept is a
real plus.

TEST DRIVE RESULTS:
This little unit makes it worth
putting down the old
reliable.